



SOLUCIONES PARA LA AGRICULTURA

Mantenga sus equipos operativos durante todo el año



LA INNOVACIÓN AL SERVICIO DE SU PRODUCCIÓN

El movimiento. En perpetua evolución, se analiza, se aprovisiona, se orienta y se domina para obtener lo mejor. Más que una simple noción, es la propia esencia de nuestro compromiso: diseñar e innovar para responder a las restricciones de hoy y del mañana.

Con usted, somos miles de personas por todo el mundo, pensando y desarrollando día a día soluciones que mejoran su producción. Entre los líderes mundiales, nuestras marcas NTN, BCA, BOWER y SNR, presentes a nivel internacional, le ofrecen las respuestas más adaptadas para construir, juntos, una sociedad más respetuosa con su entorno. Intercambiar, anticipar, y adaptarse como nosotros, a escribir la historia de la industria, el automóvil y la aeronáutica.

5.500
MILLONES DE €*
de cifra de negocio

23.000*
empleados

La proximidad de un socio internacional



118
Oficinas
comerciales

73
Fábricas

15
Centros de I+D

* Marzo 2023



El alcance de sus objetivos es lo que nos motiva.

Del trabajo de suelo al mantenimiento, pasando por la recolección, ponemos nuestros conocimientos a su disposición para proponerle productos adaptados a sus equipamientos agrícolas que han sido ya probados por las principales empresas del sector.

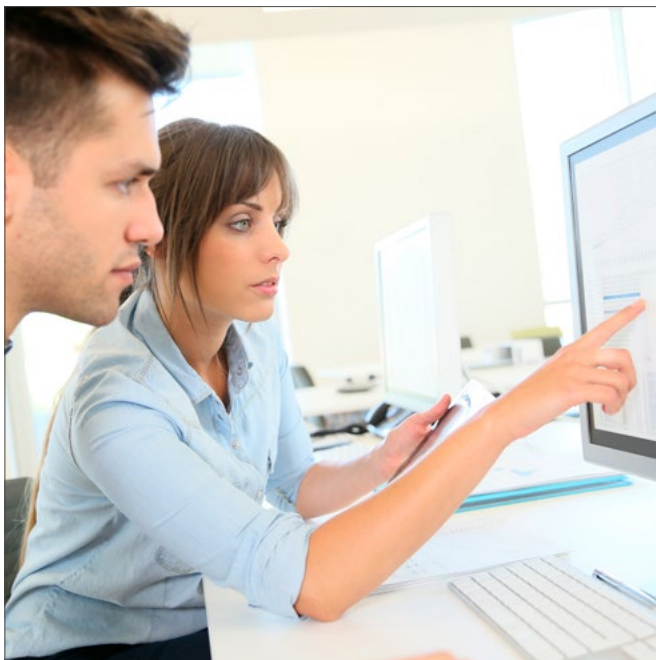

2000
soluciones dedicadas

AL MERCADO AGRÍCOLA

Más de **4**
millones
de rodamientos

PARA EQUIPOS AGRÍCOLAS
VENDIDOS CADA AÑO



UNA FRUCTÍFERA COLABORACIÓN CON EL GIGANTE DE LAS MÁQUINAS AGRÍCOLAS.

Desde hace más de 40 años, NTN EUROPE fabrica rodamientos para KHUN, líder mundial de la maquinaria agrícola. La base de esta relación: la misma pasión por la calidad y la innovación.

Líder mundial en su mercado, KHUN, fundada en 1828, ha duplicado su cifra de negocio en seis años, sobrepasando ya los 1000 millones de euros. Su desarrollo se basa en la innovación, con 100 ingenieros dedicados a I+D, de un total de 5000 colaboradores, y 1600 patentes presentadas. El objetivo de KHUN es diseñar y fabricar máquinas fiables, duraderas, innovadoras, respetuosas con el medio ambiente, y que respondan a las necesidades de sus clientes. KHUN espera de sus proveedores implicación en la calidad y en la innovación, tendiendo así conjuntamente a los mismos objetivos. En materia de rodamientos, KHUN confía en NTN EUROPE desde hace 40 años.

Duración de vida superior

Esta confianza se basa sobre todo en la capacidad de producir rodamientos reforzados, adaptados a ambientes polvorientos, bajo fuertes cargas, con condiciones de trabajo cambiantes, y en la necesidad de una fiabilidad sin fallos. "La duración de vida superior y la calidad constante de los rodamientos suministrados son para nosotros un parámetro esencial", indica Bernard Jacob, comprador en KHUN. Por ejemplo, NTN-SNR fabrica para KHUN un rodamiento de dos hileras de bolas de contacto angular, que se integra en las barras de corte de las segadoras. "Originario de la industria automóvil, este rodamiento ofrece

una excelente base técnica que ha sido adaptada y llevada al nivel de exigencias de las segadoras de KHUN", señala Jean-Michel Héé, responsable de las ventas de Agricultura de NTN EUROPE.

Máquinas agrícolas inteligentes

Otro parámetro de valor añadido: la innovación. "Y en particular la capacidad de nuestros principales proveedores de mantener una vigilancia tecnológica, de ser una fuente de propuestas" precisa Bernard Jacob. En esta línea, KHUN y NTN EUROPE se apoyan en una relación de confianza mutua, consolidada después de 40 años, para avanzar juntos.

Regularmente se lleva a cabo un balance de la situación de los proyectos y desarrollos en curso. "Apreciamos que haya relaciones técnicas y comerciales frecuentes entre los equipos de proyectos de nuestras dos empresas; la reactividad y la calidad de estos intercambios nos permiten avanzar y finalizar nuestros proyectos", explica Bernard Jacob. Estas reuniones nos brindan la oportunidad de diseñar máquinas agrícolas inteligentes, explotando a fondo los recursos de la electrónica embarcada, que constituye un eje principal del I+D de KHUN, y que son una de las claves para responder a las expectativas de nuestros clientes.

Nuestras soluciones

Cubren el conjunto de aplicaciones existentes en el mercado.

TRABAJO DE SUELO _____ 6

Rodamientos que se pueden adaptar a todo tipo de condiciones, para una preparación óptima del terreno antes de sembrar.

- ▶ Disminución de las frecuencias de mantenimiento.



SIEMBRA _____ 14

Soluciones que permiten garantizar un guiado robusto de los discos de sembrado.

- ▶ Precisión de sembrado y fiabilidad de funcionamiento.



COSECHA FORRAJERA _____ 16

Una oferta de rodamientos de alta velocidad que garantizan una recolección en las mejores condiciones para obtener forrajes de calidad.

- ▶ Comodidad de uso sin mantenimiento.



EMPACADO _____ 18

Una tecnología a toda prueba, dotada de estanqueidades eficaces.

- ▶ Realización de balas de alta calidad y densidad constante.



COSECHA _____ 20

Una experiencia reconocida en soluciones estancas para ambientes polucionados.

- ▶ Fiabilidad de los rodamientos para un trabajo intensivo y sin interrupción de las cosechadoras.



MANTENIMIENTO _____ 26

Dispositivos especialmente adaptados a las exigencias de las aplicaciones agrícolas.

- ▶ Equipos técnicos adaptados al mantenimiento de los rodamientos.



REFERENCIAS DE LOS PRODUCTOS _____ 28

Una oferta de los 300 productos más utilizados.

- ▶ Una respuesta técnica para cada necesidad.



NUESTRAS GAMAS ESTÁNDAR _____ 44

La agricultura también utiliza muchos productos estándar.

- ▶ La respuesta a todas sus aplicaciones.





AGRIHUB,

Una protección sin fallos para hacer frente a un entorno exigente



Prepare sus terrenos con toda tranquilidad gracias a la robustez de los AGRIHUB SNR.



ENGRASADO A VIDA

Duración de vida prolongada:

- Sistema de estanqueidad multi-labios
- Rodamiento con prestaciones superiores al estándar del mercado
- Carcasa forjada con sección constante para proteger el sistema de estanqueidad

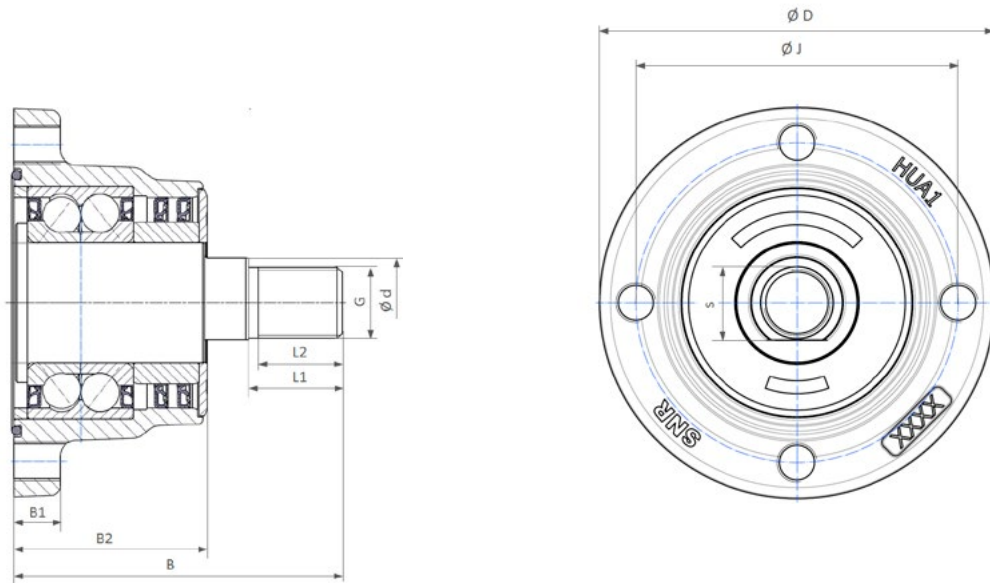

Referencias disponibles

Referencias	Número de agujeros de fijación	Diámetro de los agujeros de fijación	D	J	S	d	G	B1	B2	B	L1	L2	Diámetro de los discos	Peso (kg)
HUA14F-4M12-S01	4	M12x1.25	120	98	26	28	M22x1.5	15	60	102	28	25	< 700	2,50
HUA14F-4M12-S01	5	M12x1.25	120	98	26	28	M22x1.5	15	60	102	28	25	< 700	2,49
HUA14F-6M12-S01	6	M12x1.25	120	98	26	28	M22x1.5	15	60	102	28	25	< 700	2,48



La clase P6X

Permite un montaje rápido de sus herramientas

Gane rapidez y precisión durante la instalación gracias a nuestros rodamientos de **rodillos cónicos** de tolerancia reducida P6X.

- Procedimientos de medida simplificados: las tolerancias de anchura reducidas permiten un procedimiento de montaje más directo y rápido (menor dispersión dimensional por los rodamientos).
- Mayor estabilidad en el ajuste axial de los rodamientos, para un rendimiento óptimo de sus máquinas a lo largo del tiempo.

NTN EUROPE propone una amplia gama de rodamientos de rodillos cónicos (con cotas en pulgadas y métricas), disponibles en acero templado a fondo o en acero de cementación.

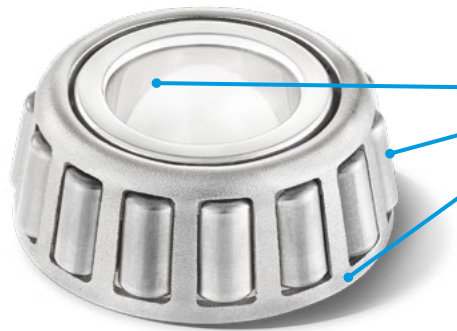

Cada elemento del rodamiento responde a las exigencias de tolerancia P6X

Tabla comparativa entre la clase de tolerancia P6X y la clase de tolerancia normal

		Diámetro exterior (mm)		Diámetro interior (mm)		Tolerancia	
		>	≤	>	≤	Normal	P6X
Ancho total				30	50	+200 μm 0	+100 μm 0
				50	80	+200 μm 0	+100 μm 0
Variación admitida de ancho del anillo interior				30	50	0 -120 μm	0 -50 μm
						0 -150 μm	0 -50 μm
Variación admitida de ancho del anillo exterior		80	120	30	50	0 -120 μm	0 -100 μm
		80	120	50	80	0 -150 μm	0 -100 μm

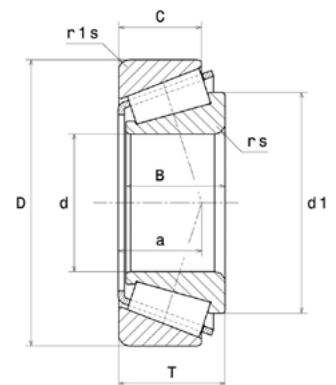

Referencias disponibles

Referencias	d	D	B	C	T	d1	a	rs	r1s	Cr	C0	Peso (Kg)
	Dimensiones (mm)									Capacidades de carga (kN)		
30210AP6X	50	90	20	17	21.75	68.4	20	1.5	1.5	76.7	92.1	0.53
32011AP6X	55	90	23	17.5	23	73.3	19.8	1.5	1.5	80.2	177	0.55
32012AP6X	60	95	23	17.5	23	77.9	23	1.5	1.5	85	124	0.58
32013AP6X	65	100	23	17.5	23	82.9	22.3	1.5	1.5	87.5	132	0.62
32014AP6X	70	110	25	19	25	90.2	23.8	1.5	1.5	104	160	0.84



Rodamiento inserto con estanqueidad AGR

Nuestra experiencia garantiza su tranquilidad

Entorno		
polucionado	muy polucionado	extremadamente polucionado

Creado para aumentar la productividad, la eficiencia y la fiabilidad en entornos severos.

Garantía de una calidad irreprochable:

- Protección contra la polución única en el mercado
- Resistencia al lavado a alta presión
- Solución de sustitución de las estanqueidades estándar



ENGRASADO A VIDA

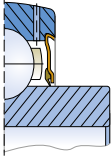
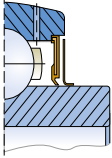
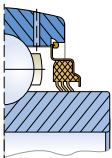
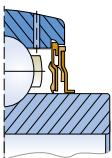
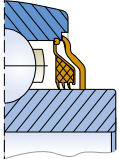

Tabla comparativa de estanqueidades

Juntas para rodamientos insertos	Descripción	Contaminación severa (barro, arena,...)	Proyecciones (piedras, tierra,...)	Limpieza de alta presión	Velocidad de rotación (% de la velocidad máxima)
	<p>Junta de simple labio</p> <p>Junta de simple labio en caucho nitrilo moldeado sobre una armadura metálica.</p> <p>Disponible en estándar en las series US y ES</p>	★ ★ ★ ★ ★	★ ★ ★ ★ ★	★ ★ ★ ★ ★	100%
	<p>Junta de simple labio con deflector</p> <p>Junta de simple labio en caucho nitrilo reforzado con una armadura metálica con un deflector rotativo adicional.</p> <p>Disponible en estándar en las series UC y EX</p>	★ ★ ★ ★ ★	★ ★ ★ ★ ★	★ ★ ★ ★ ★	100%
	<p>Junta de triple labio L3</p> <p>Junta para ambientes muy polucionados: junta de caucho nitrilo con 3 labios sostenida por una armadura de chapa tratada anticorrosión.</p> <p>Disponible en las series UC...L3 y EX...L3</p>	★ ★ ★ ★ ★	★ ★ ★ ★ ★	★ ★ ★ ★ ★	30%
	<p>Junta laberinto L4</p> <p>Junta para ambientes polucionados, con par de rotación reducido. 2 juntas de nitrilo sobre una armadura de chapa tratada anticorrosión formando un sistema de 3 labios + junta laberinto. Protección suplementaria anticorrosión de los anillos del rodamiento.</p> <p>Disponible en series UC2...L4 y EX2...L4, hasta 50 mm de diámetro interior</p>	★ ★ ★ ★ ★	★ ★ ★ ★ ★	★ ★ ★ ★ ★	40%
<p>Específico AGRICULTURA</p> 	<p>Estanqueidad tecnología « AGR » : L3 + deflector</p> <p>Junta de tipo L3 para ambientes muy polucionados, reforzada con una protección adicional: deflector zincado, montado sobre el anillo interior y dotado de un labio para cerrar el contacto con el anillo exterior. Protección suplementaria anticorrosión de los anillos del rodamiento.</p> <p>Disponible en las series UC2..AGR y EX2..AGR, hasta 50 mm de diámetro interior</p>	★ ★ ★ ★ ★	★ ★ ★ ★ ★	★ ★ ★ ★ ★	25%



Rodamiento inserto con estanqueidad AGR

Nuestra experiencia garantiza su tranquilidad

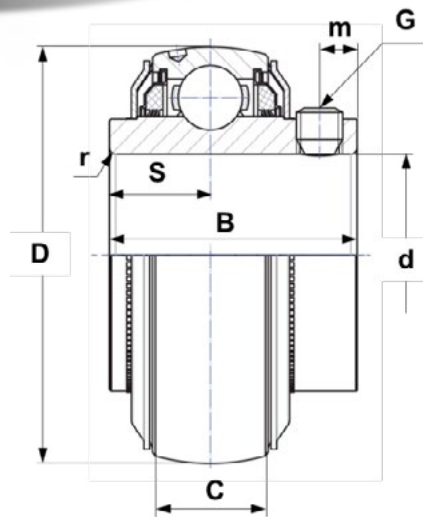
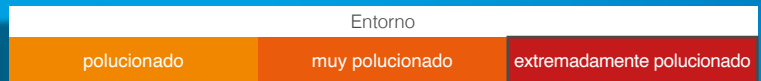

ENGRASADO A VIDA

Referencias disponibles

UC...AGR apriete por tornillo hexagonal (2 sentidos de rotación posibles)

Referencias	d	D	C	B	S	m	G	r	Capacidades de carga (kN)		Peso (Kg)
									Cr	C0	
UC206AGR ²	30	62	19	39.0	15.9	5	M6x1	0.6	19.5	11.2	0.31
UC207AGR	35	72	20	42.9	17.5	6.5	M8x1	1.1	25.7	15.2	0.5
UC208AGR	40	80	21	49.2	19	8	M8x1	1.1	29.6	18.2	0.63
UC209AGR	45	85	22	49.2	19	8	M8x1	1.1	31.85	20.8	0.73
UC210AGR	50	90	23	51.6	19	9	M8x1	1.1	35.1	23.2	0.8
UC211AGR	55	100	25	55.6	22.2	9	M8x1	1.5	43.55	29.2	1.1
UC212AGR	60	110	27	65.1	25.4	10.5	M10x1.25	1.5	52.5	32.8	1.37
UC215AGR ¹	75	130	30	77.8	33.3	12	M12x1.25	2	66	49.5	2.16
UC308AGR	40	90	28	58 ²	22.2 ²	8.5	M10x1.25	2	40.56	24	1.1
UC309AGR	45	100	30	57	22	9	M10x1.25	2	53	31.8	1.26
UC310AGR	50	110	32	70	26	13	M10x1.25	2	61.75	37.8	1.85

¹ Bajo pedido (consúltenos)

² Dimensiones de ancho superiores a la versión estándar

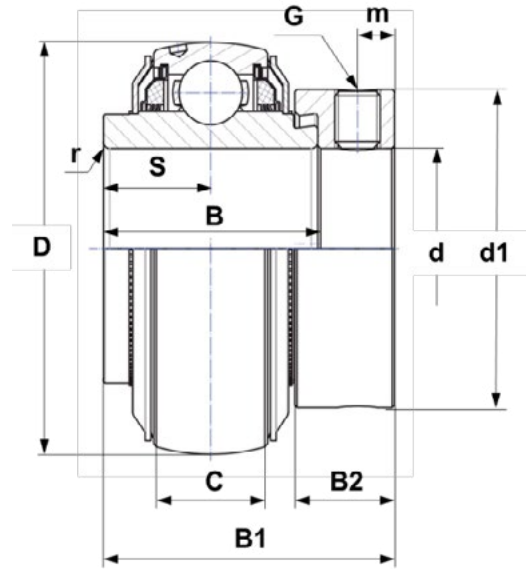

Referencias disponibles

EX...AGR APRIETE POR EXCÉNTRICA (1 ÚNICO SENTIDO DE ROTACIÓN)

Referencias	d	D	C	B	B1	S	d1	m	B2	G	r	Capacidades de carga (kN)		Peso (Kg)
	Dimensiones (mm)											Cr	C0	
EX207AGR	35	72	20	37.6	51.1	18.8	55.6	6.5	17.5	M8x1	1.1	25.7	15.2	0.64
EX208AGR	40	80	21	42.8	56.3	21.4	60.3	6.5	18.3	M8x1	1.1	29.6	18.2	0.74
EX209AGR	45	85	22	42.8	56.3	21.4	63.5	6.5	18.3	M8x1	1.1	31.85	20.8	0.87
EX210AGR	50	90	23	49.2	62.7	24.6	69.9	6.5	18.3	M8x1	1.1	35.1	23.2	1.01
EX211AGR	55	100	25	55.4	71.3	27.7	76.2	8	20.7	M10x1.25	1.5	43.55	29.2	1.35
EX212AGR	60	110	27	61.8	77.7	30.9	84.2	8	22.3	M10x1.25	1.5	52.5	32.8	1.67
EX308AGR	40	90	28	49.5 ¹	65.3 ¹	22.2 ¹	63.5	8	20.6	M10x1.25	2	40.65	24	1.28

¹ Dimensiones de ancho superiores a la versión estándar

Los insertos con estanqueidad AGR existen:

- Con opción de bola anti-rotación sobre el diámetro exterior (ej: UC309AGRRLP)
- Con cuerpo de soporte en fundición de grafito laminar (FGL) o de grafito esferoidal (FGS o fundición dúctil)

Los rodamientos insertos AGR no pueden combinarse con cualquier soporte debido a su junta reforzada. Estos han sido diseñados para ser instalados en los soportes SNR de las series P, PE, F, FE, FL y FLE, pudiendo ser también combinados con soportes de otras series.

Por favor, si está interesado en otras combinaciones, consúltenos





Tecnología Al servicio de su sembradora

Entorno		
polucionado	muy polucionado	extremadamente polucionado

La fuerza de un peso pesado en un peso pluma.

Precisión de sembrado garantizada con el rodamiento 204XAGR:

- Tecnología de 4 puntos de contacto para un guiado robusto y preciso de los discos de siembra
- Estandariedad L3 para una protección máxima contra la polución

LLU, una estanqueidad respetuosa con el medio ambiente:

- Retención de la grasa en el interior del rodamiento
- Barrera resistente a partículas exteriores y líquido

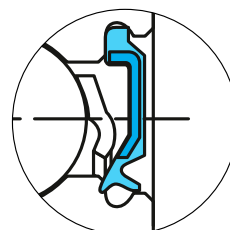
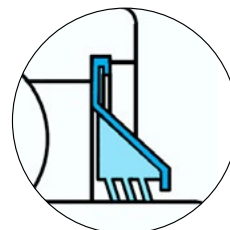

ENGRASADO A VIDA

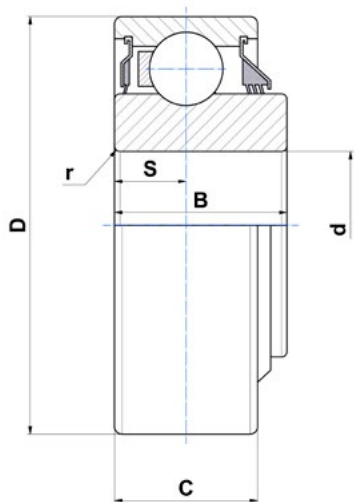

Tipo 1

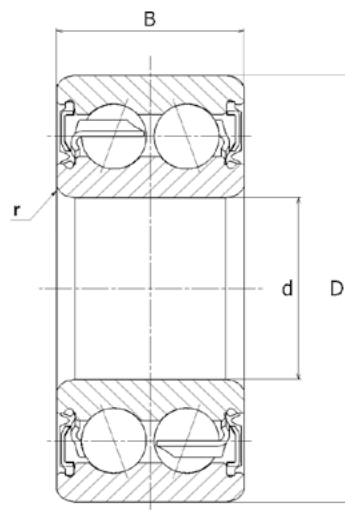

Tipo 2

Referencias disponibles

Referencias	Tipo	d	D	B	C	S	r	Capacidades de carga (kN)		Peso (Kg)
								Dimensiones (mm)		
204XAGR	1	16,027	45,225	18,669	15,494	7,747	0,86	20	12,7	0,12
TM-5204LLU	2	20	47	20,6	-	-	1	16,7	9,7	0,16

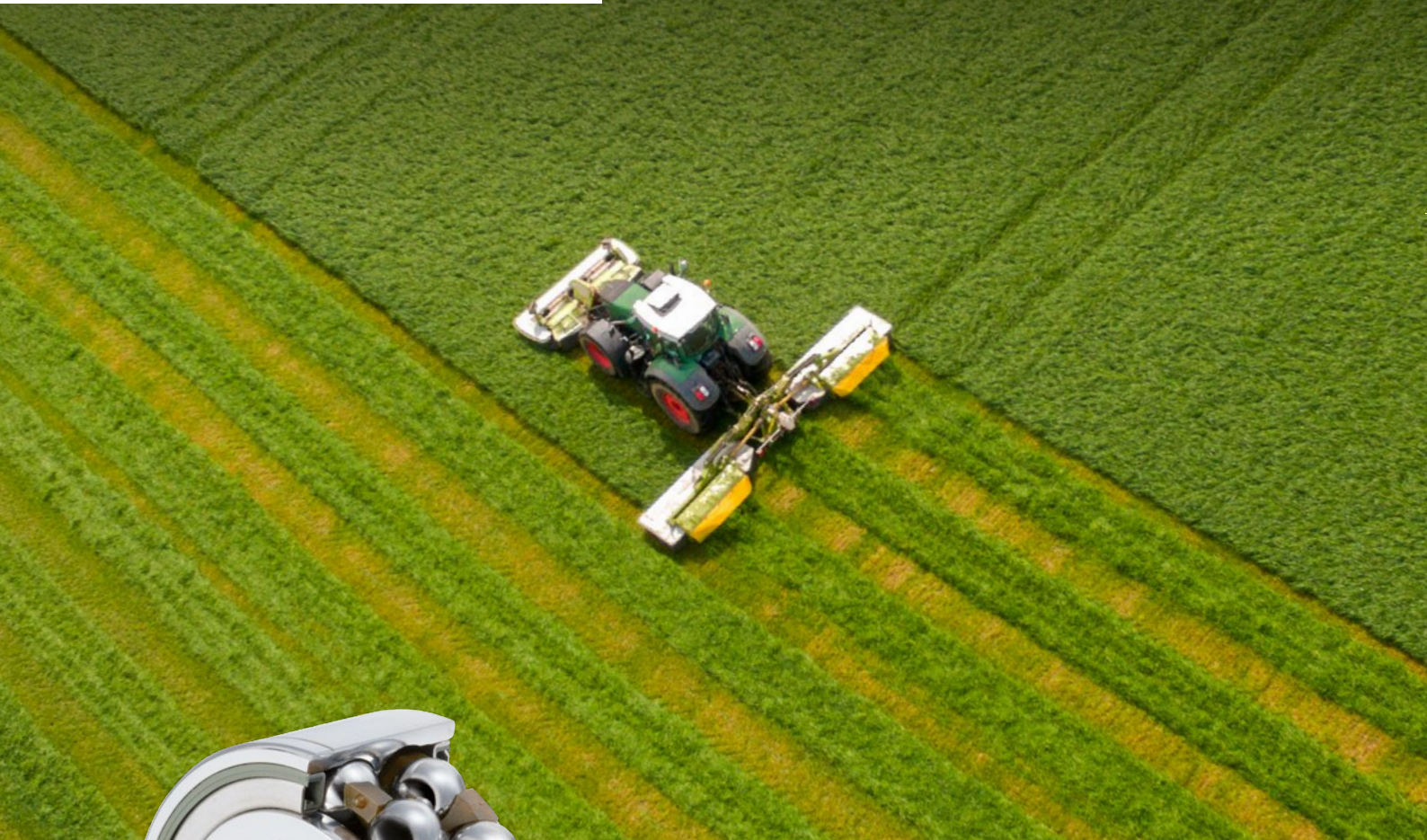

Exija lo mejor para sus cosechadoras

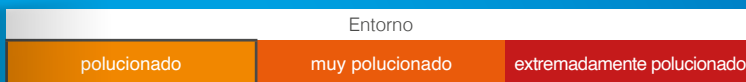

NTN EUROPE le asegura una mejor productividad aunando facilidad de montaje y velocidad de trabajo.



ENGRASADO A VIDA

Rendimiento aumentado:

- Velocidad de corte elevada gracias a la tecnología de los rodamientos de bolas
- Protección contra un ambiente difícil: hierba, barro, piedras (junta diseñada para las aplicaciones agrícolas)

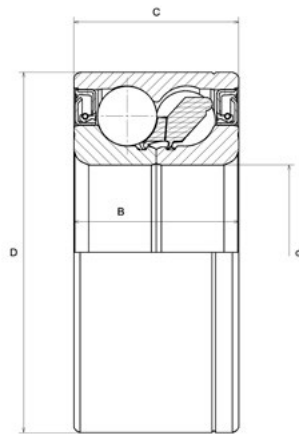

Tipo 1

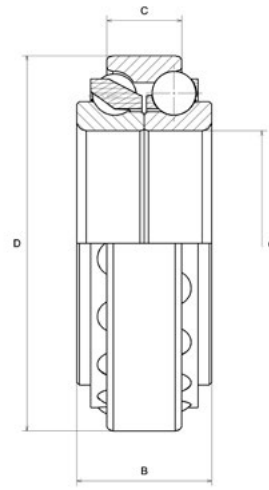

Tipo 2

Referencias disponibles

Dos hileras de bolas

Referencias	Tipo	d	D	B	C	Capacidades de carga (kN)		Peso (Kg)
						Dimensiones (mm)		
GB44386	1	34.976	72.04	33	33	73.3	40	0.6
GB40878	1	35	72	33	33	73.3	40	0.56
GB12508	2	45	75	27	15	35	34	0.345
GB10721	2	45	75	23	15	35	34	0.316

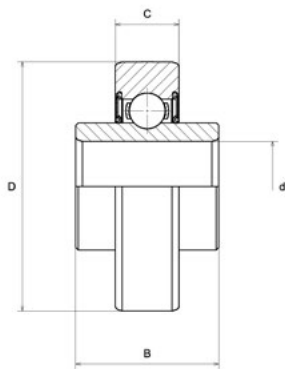

Tipo 1

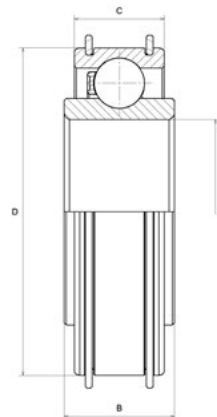

Tipo 2

Referencias disponibles

Una hilera de bolas

Referencias	Tipo	d	D	B	C	Capacidades de carga (kN)		Peso (Kg)
						Dimensiones (mm)		
AB12160	1	17	47	25	12	9.5	4.75	0.15
AB12572	1	17	47	27	12	9.5	4.75	0.14
AB41275	2	45	80	27	22	33	21.3	0.39



Inserto de agujero hexagonal para sus empacadoras

Entorno		
polucionado	muy polucionado	extremadamente polucionado

Un funcionamiento fiable durante los períodos de trabajo en continuo.

Facilidad de montaje:

- Fijación simplificada del anillo interior sobre el eje

Eficiencia del equipo:

- Estanqueidad específica a las aplicaciones agrícolas: junta de caucho protegida por un deflector exterior de chapa



Estos productos pueden ser suministrados con un soporte de chapa gruesa, consúltenos.

> Encuentre nuestras soluciones de engrase en las páginas 26 y 27 de este catálogo

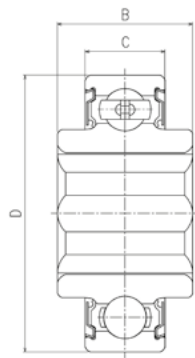

Tipo 1

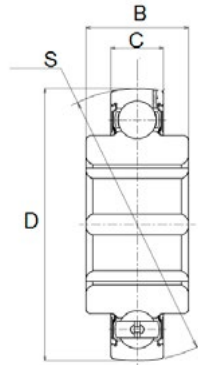

Tipo 2

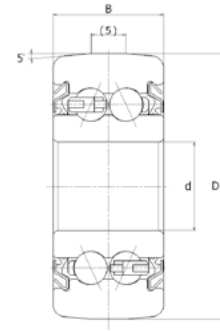

Tipo 3

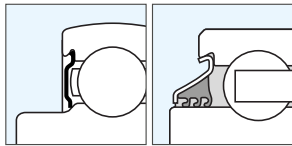

Estandeidad A Estandeidad B

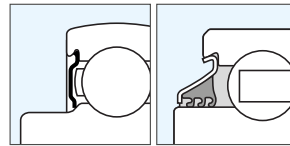

Estandeidad A Estandeidad B

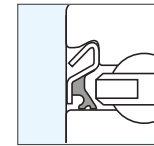

Estandeidad C

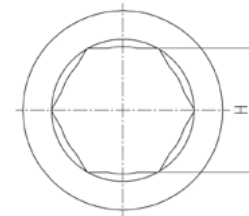

Referencias disponibles

Referencias	Tipo	Estandeidad	d o H	D	B	C	S	Capacidades de carga (kN)		Peso (Kg)
								Cr	C0	
DF0109LL	3	C	12.7	38.2	15.9	15.9	-	8.5	5.3	0.104
1AH04-11/16LLM	1	A	17.653	47	21	14	-	12.8	6.65	0.13
1AH05-7/8	1	A	22.25	52	25.4	15	-	14	7.85	0.16
1AH05-7/8LLM	1	A	22.25	52	25.4	15	-	14	7.85	0.16
1AH06-1LLS	1	B	25.425	62	24	16	-	19.5	11.3	0.24
1AH06-1LLX	1	A	25.425	62	24	16	-	19.5	11.3	0.24
2AH06-1	2	A	25.425	62	24	16	62	19.5	11.3	0.24
2AH07-1.1/8	2	A	28.6	72	37.7	17	72	25.7	15.3	0.45
SBX0762LLM	2	A	28.6	72	25	19	72	25.7	15.3	0.35
SBX08A35LLS	1	B	31.775	80	36.5	18	-	32.5	19.8	0.61
SBX08A54LLS	2	B	31.775	80	36.5	22	80	29.1	17.8	0.67
SBX10A05LLS	1	B	31.877	90	36.45	22	-	39	25.7	0.75
SBX08A31LLM	2	A	34.95	80	36.5	21	80	29.1	17.8	0.57
SBX09A82LLM	2	A	38.1	85	30	19	85	32.5	20.4	0.54
2AH09-1.1/2	2	A	38.125	85	30	19	85	32.5	20.4	0.54



Una estanqueidad apropiada cualquiera que sea su exigencia

Entorno		
polucionado	muito polucionado	extremadamente polucionado

Junta de triple labio L3.

Diseñada para los ambientes polucionados y moderadamente húmedos:

- Junta de caucho nitrilo con 3 labios soportada por una armadura de chapa con tratamiento anticorrosión

Compatibles con el conjunto de cuerpos de soportes autoalineantes en fundición gris o dúctil de las gamas NTN y SNR.

Disponibles también en conjuntos completos (ej: EXPAE206L3)



Intercambiable con nuestras
estanqueidades estándar

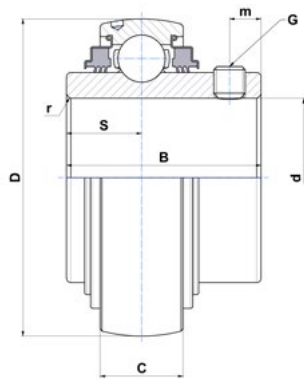

Tipo UC

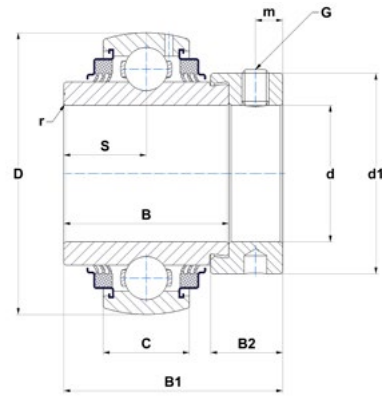

Tipo EX

Referencias disponibles

UC...L3 apriete por tornillo hexagonal (2 sentidos de rotación posibles)

Referencias	d	D	B	C	S	m	G	r	Cr	CO	Peso (Kg)
	Dimensiones (mm)								Capacidades de carga (kN)		
UC204G2L3	20	47	31	16	12,7	4,7	M6x1	0,6	12,8	6,65	0,17
UC205G2L3	25	52	34	17	14,3	5,5	M6x1	0,6	14	7,88	0,21
UC206G2L3	30	62	38,1	19	15,9	5,5	M6x1	0,6	19,5	11,2	0,32
UC207G2L3	35	72	42,9	20	17,5	6,5	M8x1	1,1	25,7	15,2	0,47
UC208G2L3	40	80	49,2	21	19	8	M8x1	1,1	29,6	18,2	0,64
UC209G2L3	45	85	49,2	22	19	8	M8x1	1,1	31,85	20,8	0,68
UC210G2L3	50	90	51,6	23	19	9	M10x1,25	1,1	35,1	23,2	0,8
UC211G2L3	55	100	55,6	25	22,2	9	M10x1,25	1,1	43,55	29,2	1,12
UC212G2L3	60	110	65,1	27	25,4	10,5	M10x1,25	1,1	52,5	32,8	1,53
UC213G2L3	65	120	65,1	28	25,4	12	M12x1,25	1,5	57,2	40	1,86
UC214G2L3	70	125	74,6	30	30,2	12	M12x1,25	2	62	45	2,05
UC215G2L3	75	130	77,8	30	33,3	12	M12x1,25	2	66	49,5	2,21
UC216G2L3	80	140	82,6	33	33,3	14	M12x1,25	2	72,5	54,2	2,79
UC217G2L3	85	150	85,7	35	34,1	14	M12x1,25	2	83,2	63,8	3,38
UC218G2L3	90	160	96	37	39,7	14	M12x1,25	2	96	71,5	4,45

EX...L3 apriete por excéntrica (1 único sentido de rotación)

Referencias	d	D	B	C	S	m	G	r	Cr	CO	r	Cr	CO	Peso (Kg)
	Dimensiones (mm)										Capacidades de carga (kN)			
EX206G2L3	30	62	19	36,4	48,3	18,2	44,5	6	15,9	M8x1	0,6	19,5	11,2	0,41
EX208G2L3	35	72	20	37,6	51,1	18,8	60,3	6,5	17,5	M8x1	1,1	25,7	15,2	0,6
EX209G2L3	45	85	22	42,8	56,3	21,4	63,5	6,5	18,3	M8x1	1,1	31,85	20,8	0,87
EX210G2L3	50	90	23	49,2	62,7	24,6	69,9	6,5	18,3	M8x1	1,1	35,1	23,2	1,01
EX212G2L3	60	110	27	61,8	77,7	30,9	84,2	8	22,3	M10x1,25	1,5	52,5	32,8	1,87
EX214G2L3	70	125	30	68,2	85,7	34,1	96,8	8,5	23,5	M10x1,25	2	62	45	2,57



Una estanqueidad apropiada cualquiera que sea su exigencia

Entorno		
polucionado	muy polucionado	extremadamente polucionado

Junta laberinto L4.

Desarrollada para los ambientes muy polucionados y sometidos a proyección de agua:

- 2 juntas de nitrilo sobre una armadura de chapa con tratamiento anticorrosión formando un sistema de 3 labios + junta laberinto
- Protección suplementaria anticorrosión de los anillos del rodamiento

Compatibles con el conjunto de cuerpos de soportes autoalineantes en fundición gris o dúctil de las gamas NTN y SNR.

Disponibles también en conjuntos completos (ej: UCFL207L4)



Intercambiable con nuestras
estanqueidades estándar

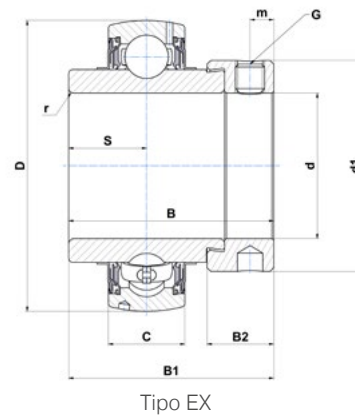
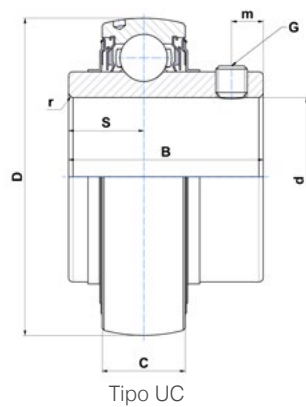

Referencias disponibles

UC...L4 apriete por tornillo hexagonal (2 sentidos de rotación posibles)

Referencias	d	D	B	C	S	m	G	r	Cr	CO	Peso (Kg)
	Dimensiones (mm)								Capacidades de carga (kN)		
UC204G2L4	20	47	31	16	12.7	4.7	M6x1	0.6	12.8	6.65	0.17
UC205G2L4	25	52	34	17	14.3	5.5	M6x1	0.6	14	7.88	0.21
UC206G2L4	30	62	38.1	19	15.9	5.5	M6x1	0.6	19.5	11.2	0.32
UC207G2L4	35	72	42.9	20	17.5	6.5	M8x1	1.1	25.7	15.2	0.47
UC208G2L4	40	80	49.2	21	19	8	M8x1	1.1	29.6	18.2	0.64
UC210G2L4	50	90	51.6	23	19	9	M10x1.25	1.1	35.1	23.2	0.8

EX...L4 apriete por excéntrica (1 único sentido de rotación)

Referencias	d	D	B	C	B1	S	d1	m	B2	G	r	Cr	CO	Peso (Kg)
	Dimensiones (mm)										Capacidades de carga (kN)			
EX204G2L4	20	47	16	34	43.5	17	33.3	5	13.5	M6x1	0.6	12.8	6.65	0.22
EX205G2L4	25	52	17	34.8	44.3	17.4	38.1	5	13.5	M6x1	0.6	14	7.88	0.25
EX206G2L4	30	62	19	36.4	48.3	18.2	44.5	6	15.9	M6x1	0.6	19.5	11.2	0.41
EX207G2L4	35	72	37.6	20	51.1	18.8	55.6	6.5	17.5	M8x1	1.1	25.7	15.2	0.6
EX208G2L4	40	80	42.8	21	56.3	21.4	60.3	6.5	18.3	M8x1	1.1	29.6	18.2	0.78
EX209G2L4	45	85	22	42.8	56.3	21.4	63.5	6.5	18.3	M8x1	1.1	31.85	20.8	0.87
EX210G2L4	50	90	23	49.2	62.7	24.6	69.9	6.5	18.3	M8x1	1.1	35.1	23.2	1.01



Una estanqueidad apropiada cualquiera que sea su exigencia

Entorno		
polucionado	muy polucionado	extremadamente polucionado

Estanqueidad "AGR": L3 + deflector.



ENGRASADO A VIDA

Diseñada para los ambientes extremadamente polucionados y húmedos:

- Deflector zincado equipado con un labio para sellar el contacto con el anillo exterior (zincado)
- Protección suplementaria anticorrosión de los anillos del rodamiento (tratamiento de superficie)
- Resistencia a los choques garantizada por el espesor del deflector

Los rodamientos insertos AGR no pueden combinarse con cualquier soporte debido a su junta reforzada. Estos han sido diseñados para ser instalados en los soportes SNR de las series P, PE, F, FE, FL y FLE, pudiendo ser también combinados con soportes de otras series.

Por favor, si está interesado en otras combinaciones, consúltenos.



Intercambiable con nuestras
estanqueidades estándar

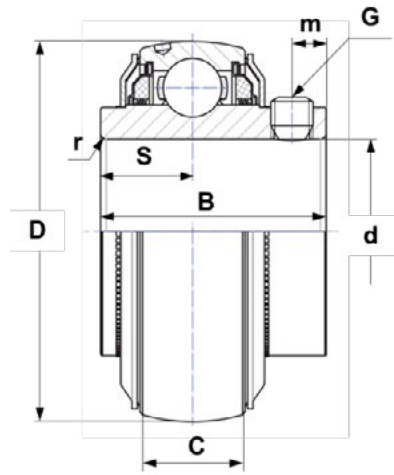

Tipo UC

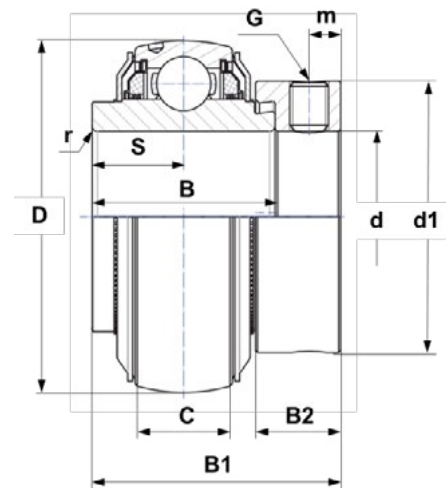

Tipo EX

Referencias disponibles

UC...AGR apriete por tornillo hexagonal (2 sentidos de rotación posibles)

Referencias	d	D	C	B	S	m	G	r	Capacidades de carga (kN)		Peso (Kg)
									Cr	C0	
UC206AGR²	30	62	19	39.0	15.9	5	M6x1	0.6	19.5	11.2	0.31
UC207AGR	35	72	20	42.9	17.5	6.5	M8x1	1.1	25.7	15.2	0.5
UC208AGR	40	80	21	49.2	19	8	M8x1	1.1	29.6	18.2	0.63
UC209AGR	45	85	22	49.2	19	8	M8x1	1.1	31.85	20.8	0.73
UC210AGR	50	90	23	51.6	19	9	M8x1	1.1	35.1	23.2	0.8
UC211AGR	55	100	25	55.6	22.2	9	M8x1	1.5	43.55	29.2	1.1
UC212AGR	60	110	27	65.1	25.4	10.5	M10x1.25	1.5	52.5	32.8	1.37
UC215AGR¹	75	130	30	77.8	33.3	12	M12x1.25	2	66	49.5	2.16
UC308AGR	40	90	28	58 ²	22.2 ²	8.5	M10x1.25	2	40.56	24	1.1
UC309AGR	45	100	30	57	22	9	M10x1.25	2	53	31.8	1.26
UC310AGR	50	110	32	70	26	13	M10x1.25	2	61.75	37.8	1.85

¹ Bajo pedido (consúltenos)

² Dimensiones de anchura superiores a la versión estándar

EX...AGR apriete por excéntrica (1 único sentido de rotación)

Referencias	d	D	C	B	B1	S	d1	m	B2	G	r	Capacidades de carga (kN)		Peso (Kg)
												Cr	C0	
EX207AGR	35	72	20	37.6	51.1	18.8	55.6	6.5	17.5	M8x1	1.1	25.7	15.2	0.64
EX208AGR	40	80	21	42.8	56.3	21.4	58	6.5	18.3	M8x1	1.1	29.6	18.2	0.74
EX209AGR	45	85	22	42.8	56.3	21.4	63.5	6.5	18.3	M8x1	1.1	31.85	20.8	0.87
EX210AGR	50	90	23	49.2	62.7	24.6	66.9	6.5	18.3	M8x1	1.1	35.1	23.2	1.01
EX211AGR	55	100	25	55.4	71.3	27.7	76.2	8	20.7	M10x1.25	1.5	43.55	29.2	1.35
EX212AGR	60	110	27	61.8	77.7	30.9	82	8	22.3	M10x1.25	1.5	52.5	32.8	1.67
EX308AGR	40	90	28	49.5 ¹	65.3 ¹	22.2 ¹	63.5	8	20.6	M10x1.25	2	40.65	24	1.28

¹ Dimensiones de anchura superiores a la versión estándar



Nuestra gama de mantenimiento para aumentar su productividad

DRIVE BOOSTER Nueva generación

Más de la mitad de los fallos de los rodamientos se deben a una lubricación deficiente. Drive Booster le permite simplificar su mantenimiento y aumentar su productividad.

Ventajas:

- Lubricación constante de los rodamientos
- Ahorro de tiempo
- Fiabilidad con respecto a la cantidad de lubricante dispensado
- Fácil de integrar sin modificar la instalación
- Componentes reutilizables

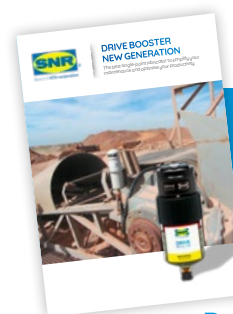

Descargue nuestro catálogo
DRIVE BOOSTER



Bomba manual y engrase

La herramienta de engrase ideal para las explotaciones agrícolas.

La bomba puede ser accionada con una mano:

- Lubricación precisa gracias a un conector de engrase especial desarrollado por NTN EUROPE.
- Una gama de lubricación específica para sus aplicaciones.



HEAVY DUTY: años de experiencia al servicio de aplicaciones extremas

La solución adoptada por la profesión.

Una lubricación apropiada para las aplicaciones agrícolas:

- Grasa de primera calidad para aplicaciones intensivas sometidas a fuertes cargas
- Muy buena protección contra el desgaste y la corrosión de los rodamientos

Referencias de productos

Una oferta de los 300 productos más utilizados.
Una respuesta técnica para cada necesidad.

Rodamientos de bolas de una hilera

Referencias	d	D	B	C	Peso (Kg)	Tipo de estanqueidad
	Dimensiones (mm)					
TMB308LCV38	40,000	90,000	23,000	-	0,630	D
TMB209	45,000	85,000	19,000	-	0,393	-
AB40320	50,000	72,000	13,000	-	0,164	-
AB41377	50,000	80,000	16,000	-	0,226	-
AB41700	50,000	90,000	20,000	-	0,462	-
TMB210LCC3	50,000	90,000	20,000	-	0,454	D
6310X11LLCC4	50,000	110,000	27,000	-	1,080	D
SC1812	88,900	127,000	19,050	-	0,748	-
SBX0340	16,129	40,000	18,288	12,000	0,080	A
AB12160	17,000	47,000	25,000	12,000	0,150	E
AB12572	17,000	47,000	27,000	12,000	0,140	E
SBX05A57LLS	19,075	63,500	26,975	25,400	0,460	B
SBX1226LLS	44,958	110,000	42,850	38,250	1,756	B
AB41275	45,000	80,000	27,000	22,000	0,390	-
SBX1040LLMC3	49,212	110,000	49,200	29,000	1,510	A
SBX1078KLLS	50,000	90,000	32,000	20,000	0,650	B
XCUC211	55,000	100,000	36,000	25,000	0,890	B
SBX1227LLS	55,560	110,000	55,560	38,252	1,730	B
AB41196	100,000	130,000	16,500	15,300	0,374	-
SBX06A59LLX	28,595	62,000	24,000	16,000	0,240	A
SBX06A29LLMC3	31,750	62,000	36,500	16,000	0,260	D
SBX1508C3-EL	74,612	130,000	74,600	30,000	2,040	U
AB40854	65,000	100,000	27,000	18,000	0,490	F

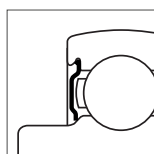
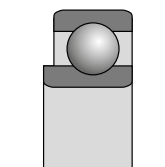
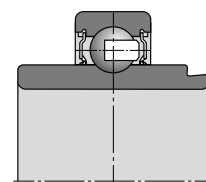
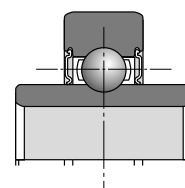
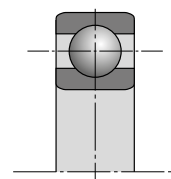

Estanqueidad A

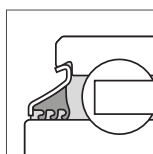

Estanqueidad B

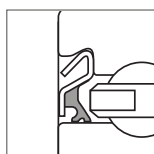

Estanqueidad C

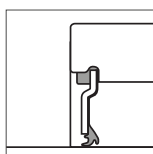

Estanqueidad D

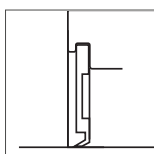

Estanqueidad E

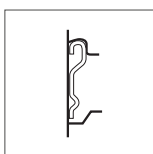

Estanqueidad F

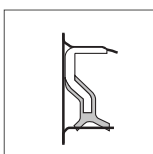

Estanqueidad G

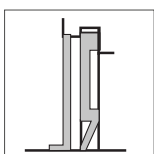

Estanqueidad H

Referencias	d	D	B	C	Peso (Kg)	Tipo de estanqueidad	
	Dimensiones (mm)						
AB12533	24,000	62,000	17,000	-	0,230	E	
AB41386	25,000	59,000	17,500	-	0,193	F	
204XAGR	16,027	45,225	18,669	15,494	0,120	A+B	
SBX06A57LLS	25,400	62,000	24,000	18,000	0,240	B	
SBX07A37LLMC3	28,600	72,000	37,700	19,000	0,480	A	
1AC08-1.3/16C3	30,175	80,000	30,200	18,000	0,610	B	
SBX09A51LLS	44,958	85,000	42,850	33,300	0,740	B	
SBX09A59LLSC3	45,161	85,000	36,513	22,000	0,580	B	
SBX1059LLMC3	49,212	110,000	49,200	29,000	1,430	A	
SBX1435LLS	70,000	125,000	61,925	39,675	1,950	B	
3AC09C3	45,000	85,000	30,200	-	0,590	B	
3AC09LLJC3PX1	45,000	85,000	30,200	-	0,590	B	
3AC10-1.15/16D1	49,225	90,000	30,200	-	0,648	B	
1AH04-11/16LLM	17,653	47,000	21,000	14,000	0,130	A	
1AH05-7/8	22,250	52,000	25,400	15,000	0,160	A	
1AH05-7/8LLM	22,250	52,000	25,400	15,000	0,160	A	
1AH06-1	25,425	62,000	24,000	16,000	0,240	A	
1AH06-1LLS	25,425	62,000	24,000	16,000	0,240	B	
1AH06-1LLX	25,425	62,000	24,000	16,000	0,240	B	
SBX06A83LLSC3	25,425	62,000	24,000	18,000	0,360	B	
SBX08A40LLSC3	29,972	85,738	36,500	30,200	0,900	B	
SBX08A35LLSC3	31,775	80,000	36,500	18,000	0,610	B	
SBX0787LLSC4	31,780	72,000	37,700	19,000	0,460	B	
SBX07A02LLSC4	31,780	72,000	37,700	19,000	0,460	B	
SBX10A05LLSC3	31,877	90,000	36,450	22,000	0,750	B	

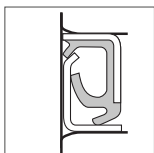

Estanqueidad J

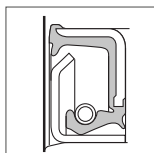

Estanqueidad K

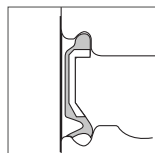

Estanqueidad LU

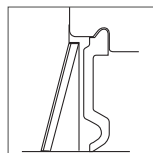

Estanqueidad U

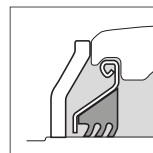

Estanqueidad AGR

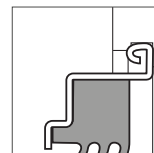

Estanqueidad L3

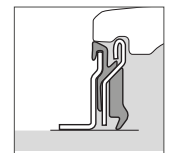

Estanqueidad L4

Rodamientos de bolas de una hilera

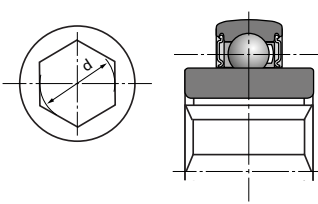
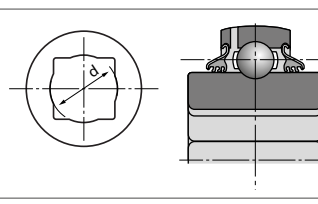
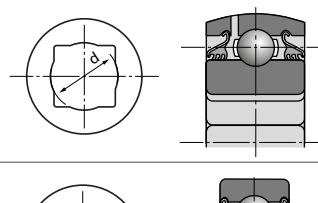
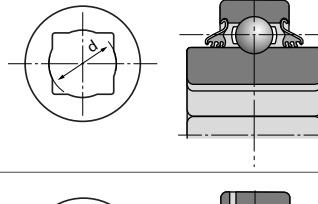
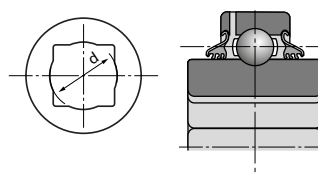
Referencias	d	D	B	C	Peso (Kg)	Tipo de estanqueidad	
	Dimensiones (mm)						
2AH05-7/8	22,250	52,000	25,400	15,000	0,160	A	
2AH05-7/8LLM	22,250	52,000	25,400	15,000	0,160	A	
2AH06-1	25,425	62,000	24,000	16,000	0,240	A	
2AH06-1/L	25,425	62,000	24,000	16,000	0,240	A	
2AH06-1LLX	25,425	62,000	24,000	16,000	0,240	A	
SBX06A40LLSC4	26,568	62,000	24,000	16,000	0,240	B	
SBX0762LLMC4	28,600	72,000	25,000	19,000	0,350	A	
SBX07A25LLMC3	28,600	72,000	25,000	17,000	0,380	A	
2AH07-1.1/8	28,600	72,000	37,700	17,000	0,450	A	
2AH07-1.1/8D1	28,600	72,000	37,700	17,000	0,450	A	
SBX08A54LLSC3	31,775	80,000	36,500	22,000	0,670	B	
2AH07-1.1/4	31,780	72,000	37,700	17,000	0,403	A	
SBX08A31LLMC3	34,950	80,000	36,500	21,000	0,570	A	
SBX09A82LLMC3	38,100	85,000	30,000	19,000	0,540	A	
SBX09A95LLXC3	38,100	85,000	30,000	19,000	0,540	A	
2AH09-1.1/2	38,125	85,000	30,000	19,000	0,540	A	
2AH09-1.1/2D1	38,125	85,000	30,000	19,000	0,540	A	
1AS08-1.1/8	29,972	80,000	36,500	30,200	0,617	B	
2AS09-1.1/4D1	32,766	85,000	36,500	30,200	0,760	B	
SBX09A47LLSC3	33,020	85,000	36,513	30,163	0,760	B	
3AS11-1.1/2CN	38,890	100,000	33,300	-	1,100	B	
5AS08-1.1/8	29,972	80,000	36,500	18,000	0,623	B	
6AS08-1.1/8C3	29,972	80,000	36,500	30,200	0,730	B	
SBX1173LLS	38,430	100,000	44,450	33,300	1,220	B	
7AS10-1.1/8D1	29,972	90,000	30,200	30,200	0,932	B	

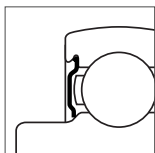

Estanqueidad A

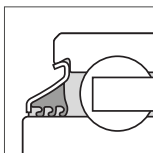

Estanqueidad B

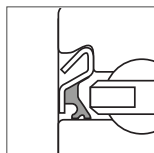

Estanqueidad C

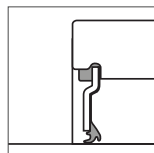

Estanqueidad D

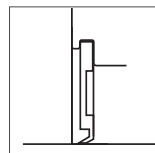

Estanqueidad E

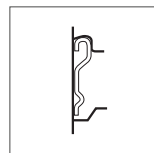

Estanqueidad F

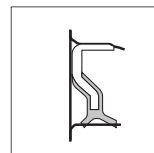

Estanqueidad G

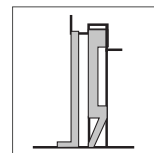

Estanqueidad H

Referencias	d	D	B	C	Peso (Kg)	Tipo de estanqueidad
	Dimensiones (mm)					
UC202-010D1	15,875	47,000	31,000	17,000	0,196	U
UC204-012D1	19,050	47,000	31,000	17,000	0,173	U
UC204G2L3	20,000	47,000	31,000	16,000	0,170	L3
UC204G2L4	20,000	47,000	31,000	16,000	0,170	L4
UC205-014D1	22,225	52,000	34,100	17,000	0,226	U
UC205G2L3	25,000	52,000	34,000	17,000	0,210	L3
UC205G2L4	25,000	52,000	34,000	17,000	0,210	L4
UC205-100D1	25,400	52,000	34,100	17,000	0,195	U
UC205-100D1LLJ	25,400	52,000	34,100	17,000	0,200	B
UC206-102D1	28,575	62,000	38,100	19,000	0,345	U
UC206AGR	30,000	62,000	19,000	38,100	0,310	AGR
UC206D1LLJ	30,000	62,000	38,100	19,000	0,320	B
UC206G2L3	30,000	62,000	38,100	19,000	0,320	L3
UC206G2L4	30,000	62,000	38,100	19,000	0,320	L4
UC206-103D1	30,162	62,000	38,100	19,000	0,323	U
UC206-104D1	31,750	62,000	38,100	19,000	0,320	U
UC207-104D1	31,750	72,000	42,900	20,000	0,537	U
UC207AGR	35,000	72,000	20,000	42,900	0,500	AGR
UC207D1LLJ	35,000	72,000	42,900	20,000	0,460	B
UC207G2L3	35,000	72,000	42,900	20,000	0,470	L3
UC207G2L4	35,000	72,000	42,900	20,000	0,470	L4
UC207-107D1	36,512	72,000	42,900	20,000	0,453	U
UC208-108D1	38,100	80,000	49,200	21,000	0,702	U
UC208AGR	40,000	80,000	21,000	49,200	0,630	AGR
UC208D1LLJ	40,000	80,000	49,200	21,000	0,640	B
UC208G2L3	40,000	80,000	49,200	21,000	0,640	L3
UC208G2L4	40,000	80,000	49,200	21,000	0,640	L4
UC308AGR	40,000	90,000	28,000	58,000	1,100	AGR
SBX0852	40,000	90,000	52,000	27,000	0,980	U
XUC308B164	40,000	110,000	52,000	32,000	1,850	H
UC209-111D1	42,862	85,000	49,200	22,000	0,780	U
UC209-112D1	44,450	85,000	49,200	22,000	0,714	U
UC209AGR	45,000	85,000	22,000	49,200	0,730	AGR
UC209G2L3	45,000	85,000	49,200	22,000	0,680	L3
UC309AGR	45,000	100,000	30,000	57,000	1,260	AGR
UC309AGRLP	45,000	100,000	30,000	57,000	1,260	AGR
UCX10-115D1	49,212	100,000	55,600	25,000	1,350	U
UC210AGR	50,000	90,000	23,000	51,600	0,800	AGR
UC210G2L3	50,000	90,000	51,600	23,000	0,800	L3
UC210G2L4	50,000	90,000	51,600	23,000	0,800	L4
UC310AGR	50,000	110,000	70,000	32,000	1,850	AGR
UC210-200D1	50,800	90,000	51,600	24,000	0,780	U
UC211-200D1	50,800	100,000	55,600	25,000	1,220	U
UC211AGR	55,000	100,000	25,000	55,600	1,100	AGR
UC211D1LLJ	55,000	100,000	55,600	25,000	1,040	B
UC211G2L3	55,000	100,000	55,600	25,000	1,120	L3
UC211-203D1	55,562	100,000	55,600	25,000	1,080	U
UCX11-203D1	55,562	110,000	65,100	27,000	1,740	U
UC212AGR	60,000	110,000	27,000	65,100	1,370	AGR
UC212G2L3	60,000	110,000	65,100	27,000	1,530	L3
UCX12-207D1	61,912	120,000	65,100	32,000	2,040	U
UCX13-208D1	63,500	125,000	74,600	33,000	2,450	U
UC213G2L3	65,000	120,000	65,100	28,000	1,860	L3
UC214G2L3	70,000	125,000	76,400	30,000	2,050	L3
UCX15-215D1	74,612	140,000	82,600	35,000	3,310	U
UC215AGR	75,000	130,000	30,000	77,800	2,160	AGR
UC215G2L3	75,000	130,000	77,800	30,000	2,210	L3
UCX15-300D1	76,200	140,000	82,600	35,000	3,190	U
UC216G2L3	80,000	140,000	82,600	33,000	2,790	L3
UC217G2L3	85,000	150,000	85,700	35,000	3,380	L3
UCX17-307D1	87,312	160,000	96,000	37,000	4,510	U

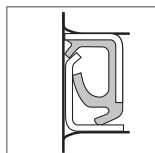
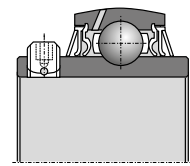

Estanqueidad J

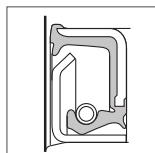

Estanqueidad K

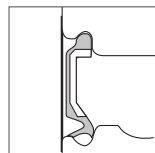

Estanqueidad LU

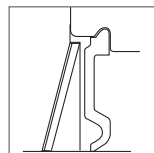

Estanqueidad U

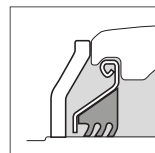

Estanqueidad AGR

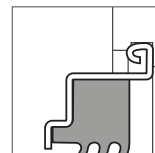

Estanqueidad L3

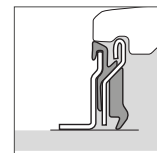

Estanqueidad L4

Rodamientos de bolas de una hilera

Referencias	d	D	B	C	Peso (Kg)	Tipo de estanqueidad
	Dimensiones (mm)					
EX204G2L4	20,000	47,000	16,000	34,000	0,220	L4
EX205G1L3	25,000	52,000	17,000	34,800	0,250	L3
EX205G2L4	25,000	52,000	17,000	34,800	0,250	L4
UEL205-100D1	25,400	52,000	44,400	17,000	0,272	U
UEL206-102D1W3	28,575	62,000	48,400	19,000	0,404	U
EX206G2L3	30,000	62,000	48,300	19,000	0,410	L3
EX206G2L4	30,000	62,000	48,300	19,000	0,410	L4
UEL206-103D1W3	30,162	62,000	48,400	19,000	0,420	U
UEL206-104D1W3	31,750	62,000	48,400	19,000	0,363	U
UEL207-106D1W3	34,925	72,000	51,100	20,000	0,600	U
EX207AGR	35,000	72,000	51,100	20,000	0,640	AGR
EX207G2L4	35,000	72,000	51,100	20,000	0,600	L4
EX208G2L3	35,000	72,000	51,100	20,000	0,600	L3
UEL208-108D1W3	38,100	80,000	56,300	21,000	0,860	U
A-UEL308-108D1W3C3	38,100	90,000	51,100	27,000	1,150	U
EX208AGR	40,000	80,000	56,300	21,000	0,740	AGR
EX208G2L4	40,000	80,000	56,300	21,000	0,780	L4
EX308B188	40,000	90,000	41,300	28,000	1,090	-
EX308AGR	40,000	90,000	65,300	28,000	1,280	AGR
UEL209-110D1W3	41,275	85,000	56,300	22,000	0,910	U
UEL209-112D1W3	44,450	85,000	56,300	22,000	0,820	U
EX209AGR	45,000	85,000	56,300	22,000	0,870	AGR
EX209G2L3	45,000	85,000	56,300	22,000	0,870	L3
EX209G2L4	45,000	85,000	56,300	22,000	0,870	L4
EX210AGR	50,000	90,000	62,700	23,000	1,010	AGR
EX210G2L3	50,000	90,000	62,700	23,000	1,010	L3
EX210G2L4	50,000	90,000	62,700	23,000	1,010	L4
UEL211-200D1W3	50,800	100,000	71,400	25,000	1,580	U
EX211AGR	55,000	100,000	71,300	25,000	1,350	AGR
SBX1125LLMC3	55,562	120,000	55,600	31,000	1,880	A
SBX1218LLMC3	55,562	130,000	61,900	33,000	2,530	A
EX212AGR	60,000	110,000	77,700	27,000	1,670	AGR
EX212G2L3	60,000	110,000	77,700	27,000	1,870	L3
UEL212-207D1W3	61,912	110,000	77,800	27,000	1,760	U
EX214G2L3	70,000	125,000	85,700	30,000	2,570	L3
UL305C3PX6	25,000	62,000	34,900	20,000	0,330	U
UL305LLS	25,000	62,000	34,900	20,000	0,330	B
A-UL308-108D1C3	38,100	90,000	41,300	27,000	0,870	U
A-UL308-108D1C4	38,100	90,000	41,300	27,000	0,870	U
AS204-012D1	19,050	47,000	25,000	14,000	0,136	E
AS205-100D1	25,400	52,000	27,000	15,000	0,160	E
AS207-104D1	31,750	72,000	34,000	17,000	0,440	E
AEL202-010D1W3	15,875	40,000	28,600	19,000	0,114	A
AEL204-012D1W3	19,050	47,000	31,000	14,000	0,167	A
AEL205-014D1W3	22,225	52,000	31,000	14,000	0,215	A
AEL205-100D1W3	25,400	52,000	31,000	15,000	0,200	A
AEL206-101D1W3	26,988	62,000	35,700	16,000	0,370	A
AEL206-102D1W3	28,575	62,000	35,700	16,000	0,335	A
AEL206-103D1W3	30,162	62,000	35,700	16,000	0,320	A
AEL206-104D1W3	31,750	62,000	35,700	16,000	0,284	A
AEL207-104D1	31,750	72,000	38,900	17,000	0,578	A
AEL207-106D1W3	34,925	72,000	38,900	17,000	0,530	A
AEL207-107D1W3	36,512	72,000	38,900	17,000	0,445	A
AEL208-108D1W3	38,100	80,000	43,700	18,000	0,640	A
AEL209-112D1W3	44,450	85,000	43,700	19,000	0,737	A

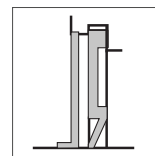
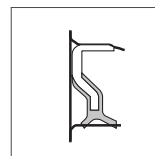
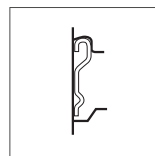
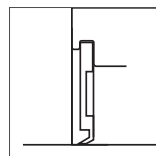
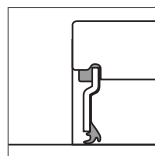
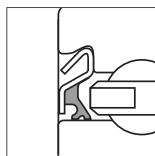
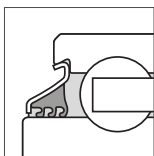
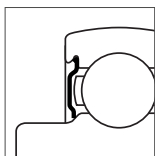
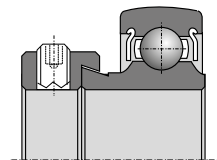
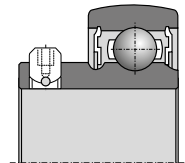
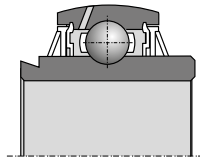
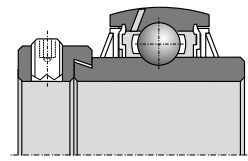

Estanqueidad A

Estanqueidad B

Estanqueidad C

Estanqueidad D

Estanqueidad E

Estanqueidad F

Estanqueidad G

Estanqueidad H

Referencias	d	D	B	C	Peso (Kg)	Tipo de estanqueidad
	Dimensiones (mm)					
JL204-012C3	19,050	47,000	21,500	15,000	0,170	A
JL205-014C3	22,225	52,000	21,500	15,000	0,150	A
JL205C3	25,000	52,000	21,500	15,000	0,130	A
A-JL205-100D1C3	25,400	52,000	21,500	15,000	0,130	A
JL205-100C3	25,400	52,000	21,500	15,000	0,130	A
JL206-102C3	26,988	62,000	23,800	18,000	0,210	A
JL206C3	30,000	62,000	23,800	18,000	0,320	A
JL206-103C3	30,162	62,000	23,800	18,000	0,200	A
JL206-104C3	31,750	62,000	23,800	18,000	0,210	A
A-JL206-104D1C3	31,750	62,000	23,800	18,000	0,240	A
A-JL207-104D1C3	31,750	72,000	25,400	19,000	0,350	A
A-JL207-106D1C3	34,925	72,000	25,400	19,000	0,320	A
AL207	35,000	72,000	25,400	17,000	0,320	A
JL207C4	35,000	72,000	25,400	19,000	0,320	A
A-JL208-108D1C3	38,100	80,000	30,200	22,000	0,480	A
JL208-108C3	38,100	80,000	30,200	22,000	0,480	A
JL208C3	40,000	80,000	30,200	22,000	0,460	A
JL210-114C3	47,625	90,000	30,200	22,000	0,670	A
A-RL205D1C3	25,000	52,000	34,900	15,000	0,260	A
RL205-100C3	25,400	52,000	34,900	15,000	0,200	A
RL205-100LLSC3	25,400	52,000	34,900	15,000	0,200	B
A-RL206D1C3	30,000	62,000	36,500	18,000	0,440	A
RL206C3	30,000	62,000	36,500	18,000	0,440	A
A-RL207-104D1LLSC3	31,750	72,000	37,600	19,000	0,450	B
RL207-104C3	31,750	72,000	37,600	19,000	0,460	A
A-RL207-106D1C3	34,925	72,000	37,600	19,000	0,412	A
RL207-106C3	34,925	72,000	37,600	19,000	0,410	A
A-RL207D1C3	35,000	72,000	37,600	19,000	0,400	A
RL207C3	35,000	72,000	37,600	19,000	0,431	A
RL208C3	35,000	72,000	42,800	22,000	0,560	A
A-RL208-108D1C3	38,100	72,000	42,800	22,000	0,400	A
RL208-108LLSC3	38,100	72,000	42,800	22,000	0,600	A
A-RL211-200D1C3	50,800	100,000	55,500	24,000	1,255	A
A-RL211D1C3	55,000	100,000	55,500	24,000	1,290	A
SBX08A65LLM	40,000	80,000	21,000	-	0,420	A
CS213D1	65,000	120,000	23,000	-	0,760	LU
SBX1706LLX4C4	85,000	130,000	22,000	-	0,930	D
AB43502	55,000	100,000	21,000	-	0,604	E

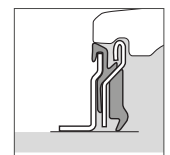
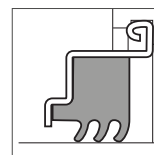
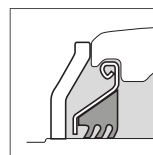
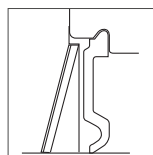
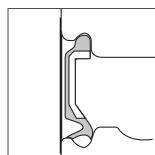
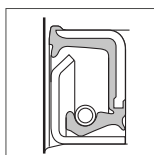
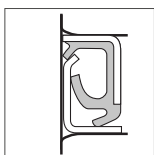
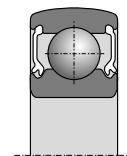
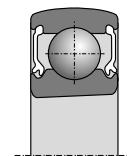
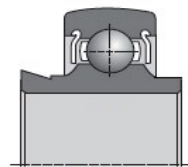
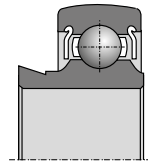

Estanqueidad J

Estanqueidad K

Estanqueidad LU

Estanqueidad U

Estanqueidad AGR

Estanqueidad L3

Estanqueidad L4

Rodamientos de bolas de doble hilera

Referencias	d	D	B	C	Peso (Kg)	Tipo de estanqueidad	
	Dimensiones (mm)						
UELS308-108D1W3	38,100	90,000	57,100	27,000	1,170	U	
ULS308-108D1C3	38,100	90,000	57,100	27,000	0,870	U	
AELS205-100D1NRW3	25,400	52,000	31,000	15,000	0,200	A	
AELS205-100D1NW3	25,400	52,000	31,000	15,000	0,188	A	
RLS205-014C3	22,225	52,000	34,900	15,000	0,240	A	
JLS206-102-A1C3	28,575	62,000	23,800	18,000	0,260	A	
JLS206-104C3	31,750	62,000	23,800	18,000	0,230	A	
JLS207-106C3	34,925	72,000	25,400	17,000	0,350	A	
DF0109LL	12,700	38,200	15,900	-	0,104	A	
TM-5204LLU	20,000	47,000	20,600	-	0,163	LU	
TM-5204LLU-N5	20,000	47,000	20,600	-	0,163	LU	
DF0766LLUA	35,000	64,000	37,000	-	0,432	LU	
GB10790	30,000	60,030	37,000	-	0,437	E	
GB12436	30,000	72,000	33,000	-	0,625	J	
GB12132	34,976	68,015	37,000	-	0,530	J	
GB44386	34,976	72,040	33,000	-	0,600	K	
GB12438	35,000	65,000	35,000	-	0,440	J	
GB12306	35,000	66,000	33,000	-	0,430	J	
GB40582	35,000	72,000	33,000	-	0,560	J	
GB40878	35,000	72,000	33,000	-	0,560	K	
GB40547	37,000	72,000	33,000	-	0,555	J	
GB12807	37,000	72,040	37,000	-	0,600	J	
GB10800	40,000	80,000	38,200	-	0,800	G	
GB40250	40,000	90,000	38,000	-	0,930	J	
GB40300	45,000	88,020	39,000	-	1,040	J	

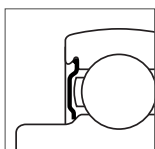

Estanqueidad A

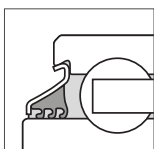

Estanqueidad B

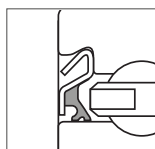

Estanqueidad C

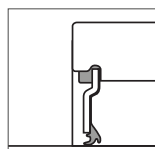

Estanqueidad D

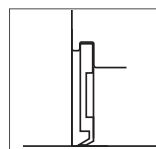

Estanqueidad E

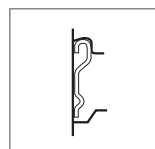

Estanqueidad F

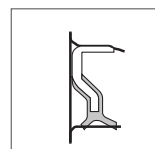

Estanqueidad G

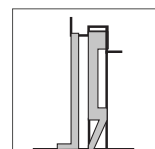

Estanqueidad H

Soportes autoalineantes

Referencias	d	L	J	C	Peso (Kg)	Tipo de estanqueidad	
	Dimensiones (mm)						
GB10890	22,500	52,020	25,000	14,000	0,208	-	
GB10827	25,000	62,030	28,000	17,000	0,362	-	
GB12508	45,000	75,000	27,000	15,000	0,345	-	
GB10721	45,000	75,000	23,000	15,000	0,316	-	
GB40385	230,000	312,000	85,000	51,000	12,700	-	
EXFE308A05AGR	40,000	130,000	101,500	-	2,820	AGR	
EXPAE206L3	30,000	98,000	76,200	-	1,000	L3	
EXPAE208L3	40,000	116,000	88,900	-	1,800	L3	
UCF207NAGR	35,000	117,000	92,000	-	1,510	AGR	
UCFE308A05AGR	40,000	130,000	101,500	-	2,690	AGR	
UCF208AGRLP	40,000	130,000	102,000	-	1,870	AGR	
D-UCF210A10AGR	50,000	143,000	111,000	-	2,480	AGR	
D-UCF211A10B176	55,000	162,000	130,000	-	3,330	AGR	
UCF211AGR	55,000	162,000	130,000	-	3,330	AGR	
D-UCF212A10AGR	60,000	175,000	143,000	-	4,340	AGR	
UCF212AGR	60,000	175,000	143,000	-	4,340	AGR	
UCFE212AGR	60,000	175,000	143,000	-	4,930	AGR	
UCFC212L3	60,000	195,000	160,000	-	4,340	L3	
UCFCE212AGR	60,000	195,000	160,000	-	3,930	AGR	
XUCFE308A05B168	40,000	130,000	101,500	45,4	2,570	AGR	
XUCFE308B01B169	40,000	130,000	101,500	51,4	2,740	AGR + L4	

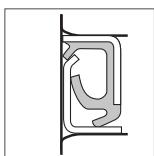

Estanqueidad J

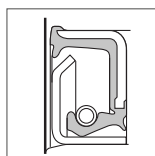

Estanqueidad K

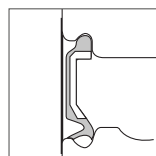

Estanqueidad LU

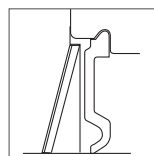

Estanqueidad U

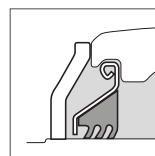

Estanqueidad AGR

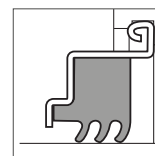

Estanqueidad L3

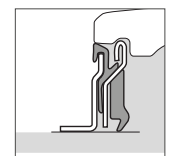

Estanqueidad L4

Soportes autoalineantes

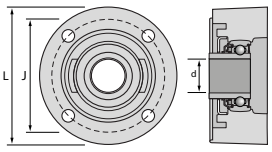
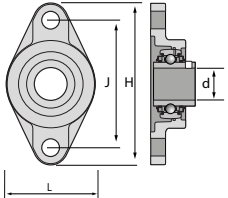
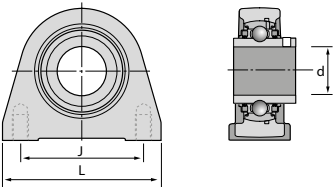
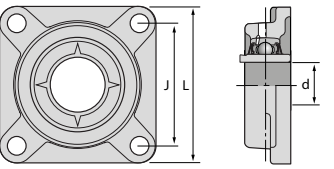
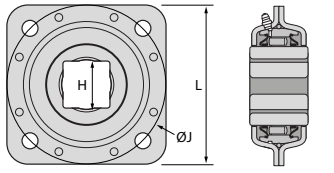
Referencias	d	L	J	H	Peso (Kg)	Tipo de estanqueidad	
	Dimensiones (mm)						
GGF25A07XUC205B186	25,000	100,000	82,000	42,000	1,590	AGR+D	
UCFL206L3	30,000	80,000	117,000	148,000	0,900	L3	
UCFL207NAGR	35,000	90,000	161,000	130,000	1,170	AGR	
UCFL208L3	40,000	100,000	144,000	175,000	1,500	L3	
UCFL208NAGR	40,000	100,000	144,000	175,000	1,540	AGR	
UCPAE206L3	30,000	98,000	76,200	-	1,000	L3	
ULF311-200D1LJ	50,800	220,000	190,000	-	5,645	U	
ULF311-200D1LJC3	50,800	220,000	190,000	-	5,645	U	
FX11A08LLS	41,224	139,7	139,7	-	2,600	B	

AGRIHUB

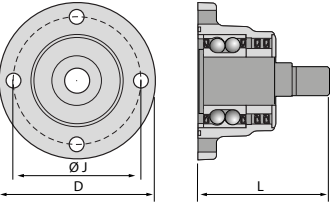
Referencias	D	J	L	Number of holes	Peso (Kg)	Estanqueidad Tipo	
	Dimensiones (mm)						
HUA14F-4M12-S01	120,000	98,000	102,000	4	2,58	J	
HUA14F-4M12-S01	120,000	98,000	102,000	5	2,57	J	
HUA14F-4M12-S01	120,000	98,000	102,000	6	2,56	J	

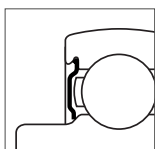

Estanqueidad A

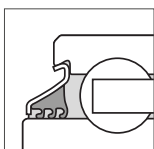

Estanqueidad B

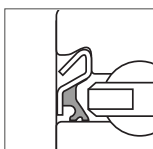

Estanqueidad C

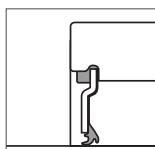

Estanqueidad D

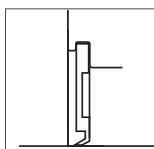

Estanqueidad E

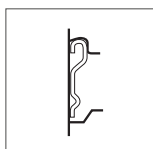

Estanqueidad F

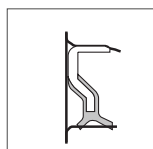

Estanqueidad G

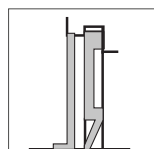

Estanqueidad H

Rodamientos de rodillos cónicos

Referencias	d	D	B	C	Peso (Kg)	Tipo de estanqueidad
	Dimensiones (mm)					
30210AP6X	50,000	90,000	20,000	17,000	0,366	-
32011AP6X	55,000	90,000	23,000	17,500	0,563	-
32012AP6X	60,000	95,000	23,000	17,500	0,589	-
32013AP6X	65,000	100,000	23,000	17,500	0,620	-
32014AP6X	70,000	110,000	25,000	19,000	0,857	-
FC40570	25,000	52,000	37,000	-	0,370	E
FC41345	25,000	52,000	37,000	-	0,370	E
ET-CR1-0846LXL	42,000	76,000	39,000	-	0,725	G

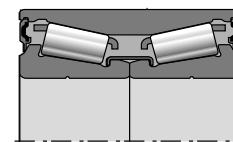
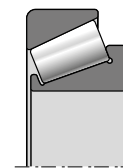

30S

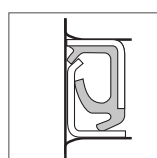

Estanqueidad **J**

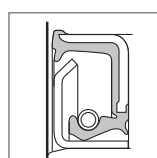

Estanqueidad **K**

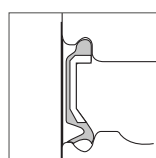

Estanqueidad **LU**

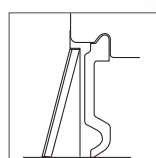

Estanqueidad **U**

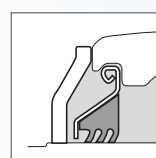

Estanqueidad **AGR**

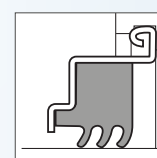

Estanqueidad **L3**

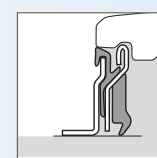

Estanqueidad **L4**

Referencias de productos / clasificación por dimensiones

Referencias	d	D	B	C	Peso (Kg)	Tipo de estanqueidad	Tipo de producto*
	Dimensiones						
DF0109LL	12,700	38,200	15,900	-	0,104	A	29
AEL202-010D1W3	15,875	40,000	28,600	19,000	0,114	A	19
UC202-010D1	15,875	47,000	31,000	17,000	0,196	U	15
204XAGR	16,027	45,225	18,669	15,494	0,120	A+B	6
SBX0340	16,129	40,000	18,288	12,000	0,080	A	2
AB12160	17,000	47,000	25,000	12,000	0,150	E	2
AB12572	17,000	47,000	27,000	12,000	0,140	E	2
1AH04-11/16LLM	17,653	47,000	21,000	14,000	0,130	A	9
JL204-012C3	19,050	47,000	21,500	15,000	0,170	A	20
AS204-012D1	19,050	47,000	25,000	14,000	0,136	E	18
AEL204-012D1W3	19,050	47,000	31,000	14,000	0,167	A	19
UC204-012D1	19,050	47,000	31,000	17,000	0,173	U	15
SBX05A57LLS	19,075	63,500	26,975	25,400	0,460	B	2
EX204G2L4	20,000	47,000	16,000	34,000	0,220	L4	16
TM-5204LLU	20,000	47,000	20,600	-	0,163	LU	29
TM-5204LLU-N5	20,000	47,000	20,600	-	0,163	LU	29
UC204G2L3	20,000	47,000	31,000	16,000	0,170	L3	15
UC204G2L4	20,000	47,000	31,000	16,000	0,170	L4	15
JL205-014C3	22,225	52,000	21,500	15,000	0,150	A	20
AEL205-014D1W3	22,225	52,000	31,000	14,000	0,215	A	19
UC205-014D1	22,225	52,000	34,100	17,000	0,226	U	15
RLS205-014C3	22,225	52,000	34,900	15,000	0,240	A	27
1AH05-7/8	22,250	52,000	25,400	15,000	0,160	A	9
1AH05-7/8LLM	22,250	52,000	25,400	15,000	0,160	A	9
2AH05-7/8	22,250	52,000	25,400	15,000	0,160	A	10
2AH05-7/8LLM	22,250	52,000	25,400	15,000	0,160	A	10
GB10890	22,500	52,020	25,000	14,000	0,208	-	32
AB12533	24,000	62,000	17,000	-	0,230	E	5
EX205G1L3	25,000	52,000	17,000	34,800	0,250	L3	16
EX205G2L4	25,000	52,000	17,000	34,800	0,250	L4	16
JL205C3	25,000	52,000	21,500	15,000	0,130	A	20
UC205G2L3	25,000	52,000	34,000	17,000	0,210	L3	15
UC205G2L4	25,000	52,000	34,000	17,000	0,210	L4	15
A-RL205D1C3	25,000	52,000	34,900	15,000	0,260	A	21
FC40570	25,000	52,000	37,000	-	0,370	E	46
FC41345	25,000	52,000	37,000	-	0,370	E	46
AB41386	25,000	59,000	17,500	-	0,193	F	5
UL305C3PX6	25,000	62,000	34,900	20,000	0,330	U	17
UL305LLS	25,000	62,000	34,900	20,000	0,330	B	17
GB10827	25,000	62,030	28,000	17,000	0,362	-	32
GGF25A07XUC205B186	25,000	L=100,000	J=82,000	H=42,000	1,590	AGR+D	39
A-JL205-100D1C3	25,400	52,000	21,500	15,000	0,130	A	20
JL205-100C3	25,400	52,000	21,500	15,000	0,130	A	20
AS205-100D1	25,400	52,000	27,000	15,000	0,160	E	18
AEL205-100D1W3	25,400	52,000	31,000	15,000	0,200	A	19
AELS205-100D1NRW3	25,400	52,000	31,000	15,000	0,200	A	26
AELS205-100D1NW3	25,400	52,000	31,000	15,000	0,188	A	26
UC205-100D1	25,400	52,000	34,100	17,000	0,195	U	15
UC205-100D1LLJ	25,400	52,000	34,100	17,000	0,200	B	15
RL205-100C3	25,400	52,000	34,900	15,000	0,200	A	21

*Tipos de productos: ver páginas 48 y 49

Referencias	d	D	B	C	Peso (Kg)	Tipo de estanqueidad	Tipo de producto*
	Dimensiones						
RL205-100LLSC3	25,400	52,000	34,900	15,000	0,200	B	21
UEL205-100D1	25,400	52,000	44,400	17,000	0,272	U	16
SBX06A57LLS	25,400	62,000	24,000	18,000	0,240	B	7
1AH06-1	25,425	62,000	24,000	16,000	0,240	A	9
1AH06-1LLS	25,425	62,000	24,000	16,000	0,240	B	9
1AH06-1LLX	25,425	62,000	24,000	16,000	0,240	B	9
2AH06-1	25,425	62,000	24,000	16,000	0,240	A	10
2AH06-1/L	25,425	62,000	24,000	16,000	0,240	A	10
2AH06-1LLX	25,425	62,000	24,000	16,000	0,240	A	10
SBX06A83LLSC3	25,425	62,000	24,000	18,000	0,360	B	9
SBX06A40LLSC4	26,568	62,000	24,000	16,000	0,240	B	10
JL206-102C3	26,988	62,000	23,800	18,000	0,210	A	20
AEL206-101D1W3	26,988	62,000	35,700	16,000	0,370	A	19
JLS206-102-A1C3	28,575	62,000	23,800	18,000	0,260	A	28
AEL206-102D1W3	28,575	62,000	35,700	16,000	0,335	A	19
UC206-102D1	28,575	62,000	38,100	19,000	0,345	U	15
UEL206-102D1W3	28,575	62,000	48,400	19,000	0,404	U	16
SBX06A59LLX	28,595	62,000	24,000	16,000	0,240	A	3
SBX07A25LLMC3	28,600	72,000	25,000	17,000	0,380	A	10
SBX0762LLMC4	28,600	72,000	25,000	19,000	0,350	A	10
2AH07-1.1/8	28,600	72,000	37,700	17,000	0,450	A	10
2AH07-1.1/8D1	28,600	72,000	37,700	17,000	0,450	A	10
SBX07A37LLMC3	28,600	72,000	37,700	19,000	0,480	A	7
5AS08-1.1/8	29,972	80,000	36,500	18,000	0,623	B	13
1AS08-1.1/8	29,972	80,000	36,500	30,200	0,617	B	11
6AS08-1.1/8C3	29,972	80,000	36,500	30,200	0,730	B	13
SBX08A40LLSC3	29,972	85,738	36,500	30,200	0,900	B	9
7AS10-1.1/8D1	29,972	90,000	30,200	30,200	0,932	B	14
GB10790	30,000	60,030	37,000	-	0,437	E	30
UC206AGR	30,000	62,000	19,000	38,100	0,310	AGR	15
JL206C3	30,000	62,000	23,800	18,000	0,320	A	20
A-RL206D1C3	30,000	62,000	36,500	18,000	0,440	A	21
RL206C3	30,000	62,000	36,500	18,000	0,440	A	21
UC206D1LLJ	30,000	62,000	38,100	19,000	0,320	B	15
UC206G2L3	30,000	62,000	38,100	19,000	0,320	L3	15
UC206G2L4	30,000	62,000	38,100	19,000	0,320	L4	15
EX206G2L3	30,000	62,000	48,300	19,000	0,410	L3	16
EX206G2L4	30,000	62,000	48,300	19,000	0,410	L4	16
GB12436	30,000	72,000	33,000	-	0,625	J	30
UCFL206L3	30,000	L=80,000	J=117,000	H=148,000	0,900	L3	40
EXPAE206L3	30,000	L=98,000	J=76,200	-	1,000	L3	34
UCPAE206L3	30,000	L=98,000	J=76,200	-	1,000	L3	41
JL206-103C3	30,162	62,000	23,800	18,000	0,200	A	20
AEL206-103D1W3	30,162	62,000	35,700	16,000	0,320	A	19
UC206-103D1	30,162	62,000	38,100	19,000	0,323	U	15
UEL206-103D1W3	30,162	62,000	48,400	19,000	0,420	U	16
1AC08-1.3/16C3	30,175	80,000	30,200	18,000	0,610	B	7
A-JL206-104D1C3	31,750	62,000	23,800	18,000	0,240	A	20
JL206-104C3	31,750	62,000	23,800	18,000	0,210	A	20
JLS206-104C3	31,750	62,000	23,800	18,000	0,230	A	28

*Tipos de productos: ver páginas 48 y 49

Referencias de productos / clasificación por dimensiones

Referencias	d	D	B	C	Peso (Kg)	Tipo de estanqueidad	Tipo de producto*
	Dimensiones						
AEL206-104D1W3	31,750	62,000	35,700	16,000	0,284	A	19
SBX06A29LLMC3	31,750	62,000	36,500	16,000	0,260	D	3
UC206-104D1	31,750	62,000	38,100	19,000	0,320	U	15
UEL206-104D1W3	31,750	62,000	48,400	19,000	0,363	U	16
A-JL207-104D1C3	31,750	72,000	25,400	19,000	0,350	A	20
AS207-104D1	31,750	72,000	34,000	17,000	0,440	E	18
A-RL207-104D1LLSC3	31,750	72,000	37,600	19,000	0,450	B	21
RL207-104C3	31,750	72,000	37,600	19,000	0,460	A	21
AEL207-104D1	31,750	72,000	38,900	17,000	0,578	A	19
UC207-104D1	31,750	72,000	42,900	20,000	0,537	U	15
SBX08A35LLSC3	31,775	80,000	36,500	18,000	0,610	B	9
SBX08A54LLSC3	31,775	80,000	36,500	22,000	0,670	B	10
2AH07-1.1/4	31,780	72,000	37,700	17,000	0,403	A	10
SBX0787LLSC4	31,780	72,000	37,700	19,000	0,460	B	9
SBX07A02LLSC4	31,780	72,000	37,700	19,000	0,460	B	9
SBX10A05LLSC3	31,877	90,000	36,450	22,000	0,750	B	9
2AS09-1.1/4D1	32,766	85,000	36,500	30,200	0,760	B	11
SBX09A47LLSC3	33,020	85,000	36,513	30,163	0,760	B	11
JLS207-106C3	34,925	72,000	25,400	17,000	0,350	A	28
A-JL207-106D1C3	34,925	72,000	25,400	19,000	0,320	A	20
A-RL207-106D1C3	34,925	72,000	37,600	19,000	0,412	A	21
RL207-106C3	34,925	72,000	37,600	19,000	0,410	A	21
AEL207-106D1W3	34,925	72,000	38,900	17,000	0,530	A	19
UEL207-106D1W3	34,925	72,000	51,100	20,000	0,600	U	16
SBX08A31LLMC3	34,950	80,000	36,500	21,000	0,570	A	10
GB12132	34,976	68,015	37,000	-	0,530	J	30
GB44386	34,976	72,040	33,000	-	0,600	K	30
DF0766LLUA	35,000	64,000	37,000	-	0,432	LU	29
GB12438	35,000	65,000	35,000	-	0,440	J	30
GB12306	35,000	66,000	33,000	-	0,430	J	30
UC207AGR	35,000	72,000	20,000	42,900	0,500	AGR	15
AL207	35,000	72,000	25,400	17,000	0,320	A	20
JL207C4	35,000	72,000	25,400	19,000	0,320	A	20
GB40582	35,000	72,000	33,000	-	0,560	J	30
GB40878	35,000	72,000	33,000	-	0,560	K	30
A-RL207D1C3	35,000	72,000	37,600	19,000	0,400	A	21
RL207C3	35,000	72,000	37,600	19,000	0,431	A	21
RL208C3	35,000	72,000	42,800	22,000	0,560	A	21
UC207D1LLJ	35,000	72,000	42,900	20,000	0,460	B	15
UC207G2L3	35,000	72,000	42,900	20,000	0,470	L3	15
UC207G2L4	35,000	72,000	42,900	20,000	0,470	L4	15
EX207AGR	35,000	72,000	51,100	20,000	0,640	AGR	16
EX207G2L4	35,000	72,000	51,100	20,000	0,600	L4	16
EX208G2L3	35,000	72,000	51,100	20,000	0,600	L3	16
UCF207NAGR	35,000	L=117,000	J=92,000	-	1,510	AGR	35
UCFL207NAGR	35,000	L=90,000	J=130,000	H=161,000	1,170	AGR	40
AEL207-107D1W3	36,512	72,000	38,900	17,000	0,445	A	19
UC207-107D1	36,512	72,000	42,900	20,000	0,453	U	15
GB40547	37,000	72,000	33,000	-	0,555	J	30
GB12807	37,000	72,040	37,000	-	0,600	J	30

*Tipos de productos: ver páginas 48 y 49

Referencias	d	D	B	C	Peso (Kg)	Tipo de estanqueidad	Tipo de producto*
	Dimensiones						
A-RL208-108D1C3	38,100	72,000	42,800	22,000	0,400	A	21
RL208-108LLSC3	38,100	72,000	42,800	22,000	0,600	A	21
A-JL208-108D1C3	38,100	80,000	30,200	22,000	0,480	A	20
JL208-108C3	38,100	80,000	30,200	22,000	0,480	A	20
AEL208-108D1W3	38,100	80,000	43,700	18,000	0,640	A	19
UC208-108D1	38,100	80,000	49,200	21,000	0,702	U	15
UEL208-108D1W3	38,100	80,000	56,300	21,000	0,860	U	16
SBX09A82LLMC3	38,100	85,000	30,000	19,000	0,540	A	10
SBX09A95LLXC3	38,100	85,000	30,000	19,000	0,540	A	10
A-UL308-108D1C3	38,100	90,000	41,300	27,000	0,870	U	17
A-UL308-108D1C4	38,100	90,000	41,300	27,000	0,870	U	17
A-UEL308-108D1W3C3	38,100	90,000	51,100	27,000	1,150	U	16
UELS308-108D1W3	38,100	90,000	57,100	27,000	1,170	U	24
ULS308-108D1C3	38,100	90,000	57,100	27,000	0,870	U	25
2AH09-1.1/2	38,125	85,000	30,000	19,000	0,540	A	10
2AH09-1.1/2D1	38,125	85,000	30,000	19,000	0,540	A	10
SBX1173LLS	38,430	100,000	44,450	33,300	1,220	B	13
3AS11-1.1/2CN	38,890	100,000	33,300	-	1,100	B	12
UC208AGR	40,000	80,000	21,000	49,200	0,630	AGR	15
SBX08A65LLM	40,000	80,000	21,000	-	0,420	A	22
JL208C3	40,000	80,000	30,200	22,000	0,460	A	20
GB10800	40,000	80,000	38,200	-	0,800	G	30
UC208D1LLJ	40,000	80,000	49,200	21,000	0,640	B	15
UC208G2L3	40,000	80,000	49,200	21,000	0,640	L3	15
UC208G2L4	40,000	80,000	49,200	21,000	0,640	L4	15
EX208AGR	40,000	80,000	56,300	21,000	0,740	AGR	16
EX208G2L4	40,000	80,000	56,300	21,000	0,780	L4	16
TMB308LCV38	40,000	90,000	23,000	-	0,630	D	1
UC308AGR	40,000	90,000	28,000	58,000	1,100	AGR	15
GB40250	40,000	90,000	38,000	-	0,930	J	31
EX308B188	40,000	90,000	41,300	28,000	1,090	-	16
SBX0852	40,000	90,000	52,000	27,000	0,980	U	15
EX308AGR	40,000	90,000	65,300	28,000	1,280	AGR	16
XUC308B164	40,000	110,000	52,000	32,000	1,850	H	15
UCFL208L3	40,000	L=100,000	J=144,000	H=175,000	1,500	L3	40
UCFL208NAGR	40,000	L=100,000	J=144,000	H=175,000	1,540	AGR	40
EXPAE208L3	40,000	L=116,000	J=88,900	-	1,800	L3	34
EXFE308A05AGR	40,000	L=130,000	J=101,500	-	2,820	AGR	33
UCFE308A05AGR	40,000	L=130,000	J=101,500	-	2,690	AGR	35
XUCFE308A05B168	40,000	L=130,000	J=101,500	-	2,570	AGR	37
XUCFE308B01B169	40,000	L=130,000	J=101,500	-	2,740	AGR + L4	38
UCF208AGRLP	40,000	L=130,000	J=102,000	-	1,870	AGR	35
UEL209-110D1W3	41,275	85,000	56,300	22,000	0,910	U	16
ET-CR1-0846LXL	42,000	76,000	39,000	-	0,725	G	46
UC209-111D1	42,862	85,000	49,200	22,000	0,780	U	15
AEL209-112D1W3	44,450	85,000	43,700	19,000	0,737	A	19
UC209-112D1	44,450	85,000	49,200	22,000	0,714	U	15
UEL209-112D1W3	44,450	85,000	56,300	22,000	0,820	U	16
SBX09A51LLS	44,958	85,000	42,850	33,300	0,740	B	7
SBX1226LLS	44,958	110,000	42,850	38,250	1,756	B	2

*Tipos de productos: ver páginas 48 y 49

Referencias de productos / clasificación por dimensiones

Referencias	d	D	B	C	Peso (Kg)	Tipo de estanqueidad	Tipo de producto*
	Dimensiones						
GB10721	45,000	75,000	23,000	15,000	0,316	-	32
GB12508	45,000	75,000	27,000	15,000	0,345	-	32
AB41275	45,000	80,000	27,000	22,000	0,390	-	2
TMB209	45,000	85,000	19,000	-	0,393	-	1
UC209AGR	45,000	85,000	22,000	49,200	0,730	AGR	15
3AC09C3	45,000	85,000	30,200	-	0,590	B	8
3AC09LLJC3PX1	45,000	85,000	30,200	-	0,590	B	8
UC209G2L3	45,000	85,000	49,200	22,000	0,680	L3	15
EX209AGR	45,000	85,000	56,300	22,000	0,870	AGR	16
EX209G2L3	45,000	85,000	56,300	22,000	0,870	L3	16
EX209G2L4	45,000	85,000	56,300	22,000	0,870	L4	16
GB40300	45,000	88,020	39,000	-	1,040	J	31
UC309AGR	45,000	100,000	30,000	57,000	1,260	AGR	15
UC309AGRLP	45,000	100,000	30,000	57,000	1,260	AGR	15
SBX09A59LLSC3	45,161	85,000	36,513	22,000	0,580	B	7
JL210-114C3	47,625	90,000	30,200	22,000	0,670	A	20
UCX10-115D1	49,212	100,000	55,600	25,000	1,350	U	15
SBX1040LLMC3	49,212	110,000	49,200	29,000	1,510	A	2
SBX1059LLMC3	49,212	110,000	49,200	29,000	1,430	A	7
3AC10-1.15/16D1	49,225	90,000	30,200	-	0,648	B	8
AB40320	50,000	72,000	13,000	-	0,164	-	1
AB41377	50,000	80,000	16,000	-	0,226	-	1
30210AP6X	50,000	90,000	20,000	17,000	0,366	-	45
AB41700	50,000	90,000	20,000	-	0,462	-	1
TMB210LCC3	50,000	90,000	20,000	-	0,454	D	1
UC210AGR	50,000	90,000	23,000	51,600	0,800	AGR	15
SBX1078KLLS	50,000	90,000	32,000	20,000	0,650	B	2
UC210G2L3	50,000	90,000	51,600	23,000	0,800	L3	15
UC210G2L4	50,000	90,000	51,600	23,000	0,800	L4	15
EX210AGR	50,000	90,000	62,700	23,000	1,010	AGR	16
EX210G2L3	50,000	90,000	62,700	23,000	1,010	L3	16
EX210G2L4	50,000	90,000	62,700	23,000	1,010	L4	16
6310X11LLCC4	50,000	110,000	27,000	-	1,080	D	1
UC310AGR	50,000	110,000	70,000	32,000	1,850	AGR	15
D-UCF210A10AGR	50,000	L=143,000	J=111,000	-	2,480	AGR	35
UC210-200D1	50,800	90,000	51,600	24,000	0,780	U	15
A-RL211-200D1C3	50,800	100,000	55,500	24,000	1,255	A	21
UC211-200D1	50,800	100,000	55,600	25,000	1,220	U	15
UEL211-200D1W3	50,800	100,000	71,400	25,000	1,580	U	16
ULF311-200D1LJ	50,800	L=220,000	J=190,000	-	5,645	U	42
ULF311-200D1LJC3	50,800	L=220,000	J=190,000	-	5,645	U	42
32011AP6X	55,000	90,000	23,000	17,500	0,563	-	45
AB43502	55,000	100,000	21,000	-	0,604	E	23
UC211AGR	55,000	100,000	25,000	55,600	1,100	AGR	15
XCUC211	55,000	100,000	36,000	25,000	0,890	B	2
A-RL211D1C3	55,000	100,000	55,500	24,000	1,290	A	21
UC211D1LLJ	55,000	100,000	55,600	25,000	1,040	B	15
UC211G2L3	55,000	100,000	55,600	25,000	1,120	L3	15
EX211AGR	55,000	100,000	71,300	25,000	1,350	AGR	16
D-UCF211A10B176	55,000	L=162,000	J=130,000	-	3,330	AGR	35

*Tipos de productos: ver páginas 48 y 49

Referencias	d	D	B	C	Peso (Kg)	Tipo de estanqueidad	Tipo de producto*
	Dimensiones						
UCF211AGR	55,000	L=162,000	J=130,000	-	3,330	AGR	35
SBX1227LLS	55,560	110,000	55,560	38,252	1,730	B	2
UC211-203D1	55,562	100,000	55,600	25,000	1,080	U	15
UCX11-203D1	55,562	110,000	65,100	27,000	1,740	U	15
SBX1125LLMC3	55,562	120,000	55,600	31,000	1,880	A	16
SBX1218LLMC3	55,562	130,000	61,900	33,000	2,530	A	16
32012AP6X	60,000	95,000	23,000	17,500	0,589	-	45
UC212AGR	60,000	110,000	27,000	65,100	1,370	AGR	15
UC212G2L3	60,000	110,000	65,100	27,000	1,530	L3	15
EX212AGR	60,000	110,000	77,700	27,000	1,670	AGR	16
EX212G2L3	60,000	110,000	77,700	27,000	1,870	L3	16
D-UCF212A10AGR	60,000	L=175,000	J=143,000	-	4,340	AGR	35
UCF212AGR	60,000	L=175,000	J=143,000	-	4,340	AGR	35
UCFE212AGR	60,000	L=175,000	J=143,000	-	4,930	AGR	35
UCFC212L3	60,000	L=195,000	J=160,000	-	4,340	L3	36
UCFCE212AGR	60,000	L=195,000	J=160,000	-	3,930	AGR	36
UEL212-207D1W3	61,912	110,000	77,800	27,000	1,760	U	16
UCX12-207D1	61,912	120,000	65,100	32,000	2,040	U	15
UCX13-208D1	63,500	125,000	74,600	33,000	2,450	U	15
32013AP6X	65,000	100,000	23,000	17,500	0,620	-	45
AB40854	65,000	100,000	27,000	18,000	0,490	F	4
CS213D1	65,000	120,000	23,000	-	0,760	LU	22
UC213G2L3	65,000	120,000	65,100	28,000	1,860	L3	15
32014AP6X	70,000	110,000	25,000	19,000	0,857	-	45
SBX1435LLS	70,000	125,000	61,925	39,675	1,950	B	7
UC214G2L3	70,000	125,000	76,400	30,000	2,050	L3	15
EX214G2L3	70,000	125,000	85,700	30,000	2,570	L3	16
SBX1508C3-EL	74,612	130,000	74,600	30,000	2,040	U	3
UCX15-215D1	74,612	140,000	82,600	35,000	3,310	U	15
UC215AGR	75,000	130,000	30,000	77,800	2,160	AGR	15
UC215G2L3	75,000	130,000	77,800	30,000	2,210	L3	15
UCX15-300D1	76,200	140,000	82,600	35,000	3,190	U	15
UC216G2L3	80,000	140,000	82,600	33,000	2,790	L3	15
SBX1706LLX4C4	85,000	130,000	22,000	-	0,930	D	22
UC217G2L3	85,000	150,000	85,700	35,000	3,380	L3	15
UCX17-307D1	87,312	160,000	96,000	37,000	4,510	U	15
SC1812	88,900	127,000	19,050	-	0,748	-	1
UC218G2L3	90,000	160,000	96,000	37,000	4,450	L3	15
AB41196	100,000	130,000	16,500	15,300	0,374	-	2
GB40385	230,000	312,000	85,000	51,000	12,700	-	32
HUA14-4M12-S01	D=120,000	J=98,000	L=102,000	4 holes	2,550	J	44
HUA14-5M12-S01	D=120,000	J=98,000	L=102,000	5 holes	2,540	J	44
HUA14-6M12-S01	D=120,000	J=98,000	L=102,000	6 holes	2,540	J	44
FX11A08LLS	H=41,224	L=139,7	J=139,7	-	2,600	B	43

*Tipos de productos: ver páginas 48 y 49

La agricultura también utiliza **muchos** productos estándar

Rodamientos rígidos de bolas

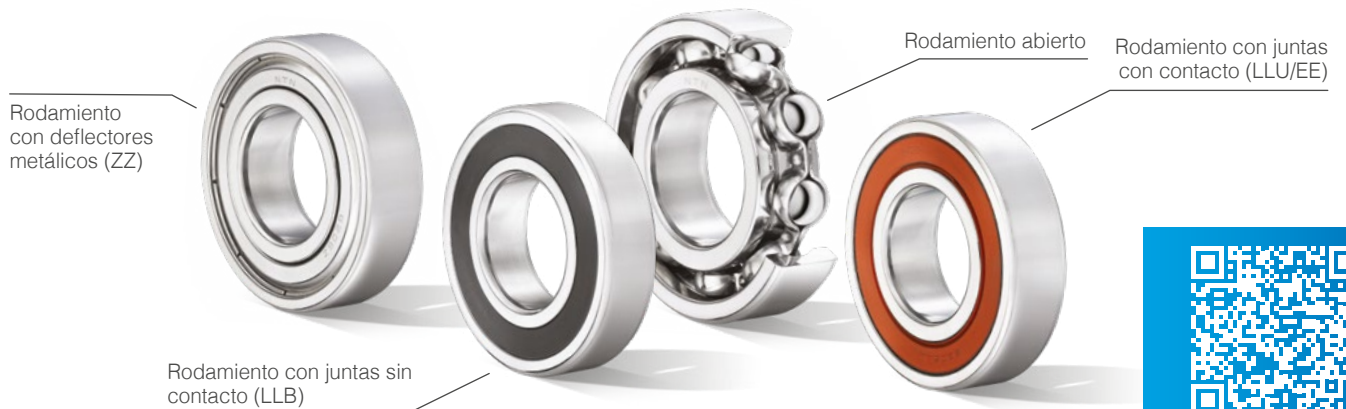

Descargue nuestro HANDBOOK

NTN y SNR: dos marcas para una solución adaptada a sus necesidades

Estanqueidad LLU:

La junta está diseñada para asegurar una interferencia entre el labio y el anillo interior:

- Retención de la grasa en el interior del rodamiento
- Prevención de la entrada de polución
- Posicionamiento del labio exterior (sin contacto) por un efecto laberinto reforzado por la ranura en V

Durante el ciclo de funcionamiento del rodamiento, la reducción de las interferencias del labio interior, ponen progresivamente en contacto al labio exterior con el anillo interior.

- Refuerzo de las prestaciones de la junta para una protección duradera.

Las juntas NTN son la solución óptima para las aplicaciones más exigentes.

Estanqueidad EE SNR:

El diseño de la junta SNR se basa en un labio en contacto y dos labios sin contacto para crear un efecto laberinto.

Esta solución de estanqueidad ofrece un par de fricción reducido para lograr el mejor compromiso entre velocidad y prestaciones de sellado.

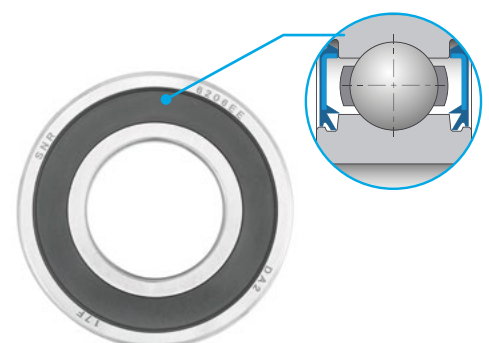
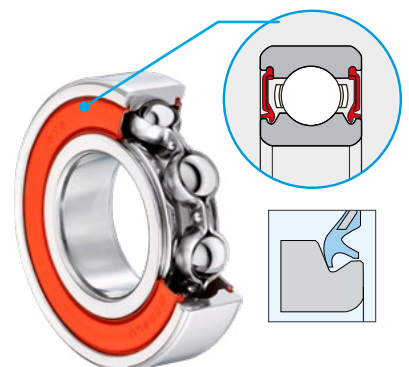

Rodamientos de rodillos cilíndricos

ULTAGE™ es la etiqueta de NTN de máximo rendimiento. Aplicado a rodamientos de rodillos cilíndricos, significa:

- Mayor capacidad de carga para una mayor duración de vida
- Menor calentamiento durante el funcionamiento para permitir una mayor velocidad de rotación

Ventajas de la gama **ULTAGE**:



* En comparación con el producto NTN estándar no ULTAGE con lubricación por aceite

Rodamientos de rodillos cónicos

Una gama completa de rodamientos de rodillos cónicos, para cubrir todas las necesidades del mercado:

- 10 series métricas más conocidas y 4 series de ángulo aumentado
- Más de 200 series en pulgadas

Aceros de alta calidad:

- Marca NTN: en acero endurecido y acero de cementación, ofrecen la misma duración
- Marca SNR: sólo en acero de cementación



Identificación

Todas nuestras referencias en acero de cementación se reconocen gracias al prefijo **4T**.



Rodamientos de agujas

Una amplia gama "made in Japan":

- Jaulas de agujas
- Casquillos de agujas
- Rodamientos de agujas de anillos macizos
- Rodamientos combinados
- Rodillos de levas y rodillos de apoyo
- Axiales



La agricultura también utiliza **muchos** productos estándar

Rodamientos de rodillos esféricos

Calidad **ULTAGE™**

ULTAGE™, la generación de rodamientos de alto rendimiento de la oferta NTN ofrece:

- Duración de vida inigualable
- Velocidades límite más elevadas
- Capacidades de carga maximizadas



i Los rodamientos diseñados según las normas **ULTAGE™** se pueden identificar con el sufijo **E**.

KIZEI®, la alternativa ideal para entornos contaminados

- Protección frente a la contaminación sólida exterior
- Mejora de la retención de grasa en el interior del rodamiento
- Dimensiones ISO que permiten reemplazar fácilmente un rodamiento de rodillos esféricos abierto
- Capacidad de carga, velocidad y temperatura de funcionamiento idénticas a las de un rodamiento abierto ULTAGE™



Rodamientos estancos con juntas de elastómero

- Diseño interno idéntico a los rodamientos abiertos de diseño ULTAGE EA
- Ancho no ISO con un aumento mínimo para integrar las estanqueidades (prefijo 10X)
- Junta de nitrilo de diseño especial que garantiza la estanqueidad por una presión de contacto constante del labio, incluso en caso de desalineación
- Rodamiento prellenado con una cantidad y una calidad de grasa, adaptadas a cargas elevadas
- Funcionamiento hasta +120°C



Soportes autoalineantes



Cuerpo del soporte en chapa

La solución más económica para las construcciones ligeras



Ventajas:

- Especialmente empleados en aplicaciones donde el peso supone una importante limitación

Características técnicas:

- Soporte en dos partes, fabricado en chapa de acero con revestimiento de zinc
- Disponibles como soportes en dos partes, brida o tensores
- Equipados con insertos universales
- Adecuado para los insertos de bolas estrechos con tornillo de fijación de tipo US..G2, insertos con excéntrica de tipo ES..G2 y de tipo CS con ajuste por interferencia
- Diseñados para cargas y velocidades de bajas a moderadas



Tipos de productos

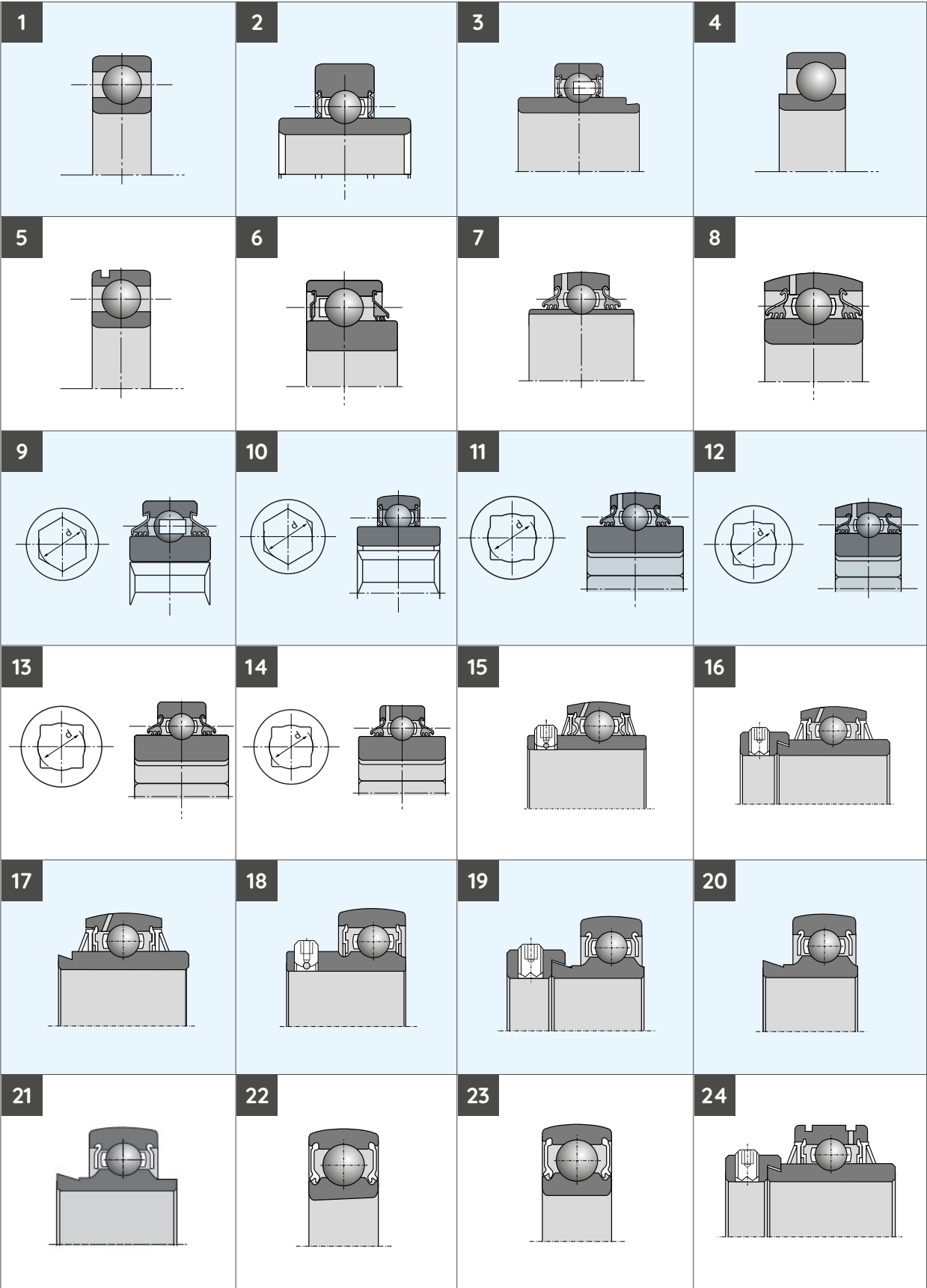

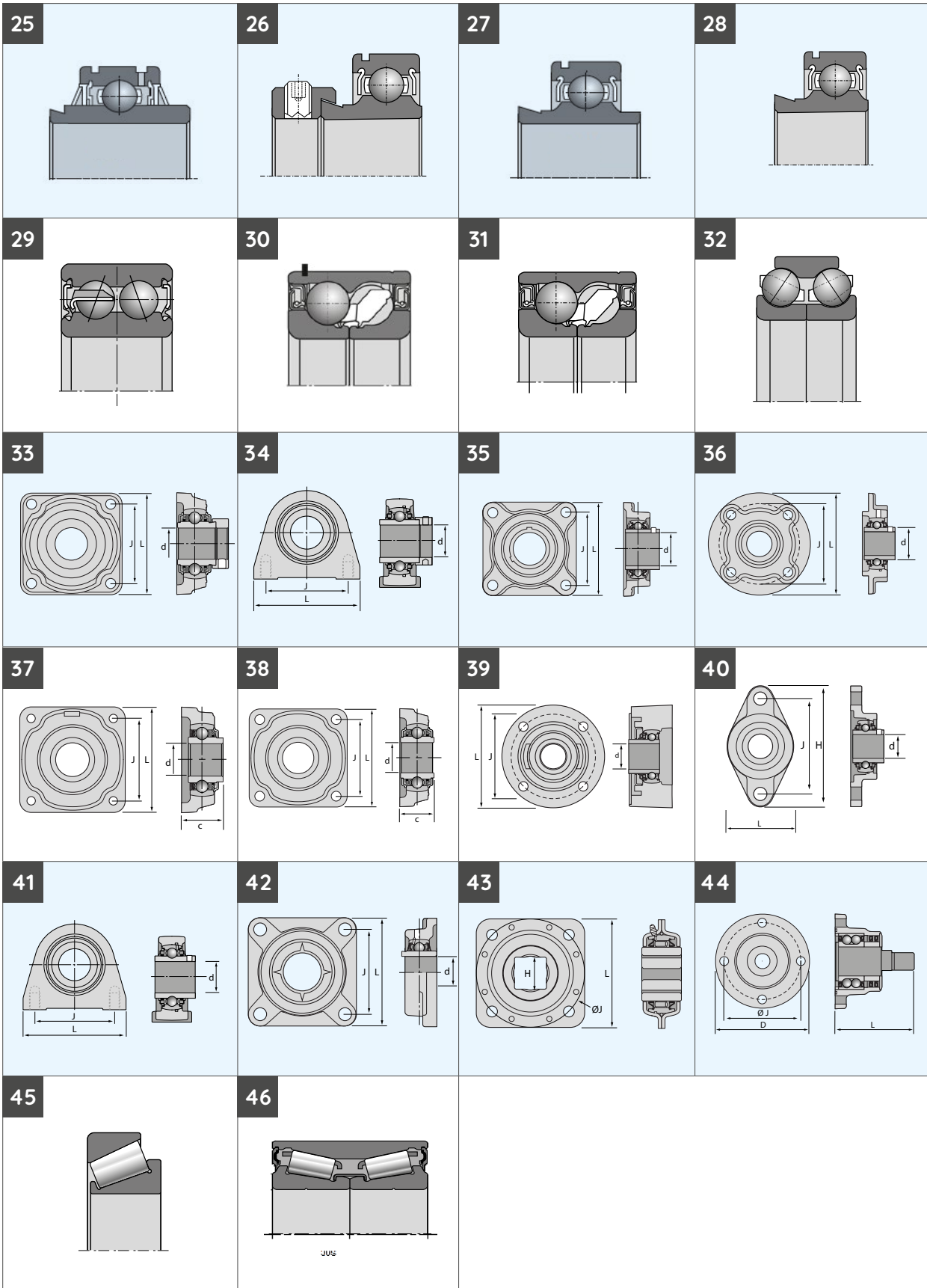





NTN

Make the world **NAMERAKA**



DOC1_AGRL_CATE_A4_Ea - CODE SAP XXXXXXXX - Document non contractuel - NTN copyright international - 1023 - Photos - NTN - PedroStudio Photos

Este documento es de la exclusiva propiedad de NTN EUROPE. Cualquier reproducción total o parcial del mismo sin el previo consentimiento de NTN EUROPE está estrictamente prohibida, pudiéndose iniciar acciones legales contra cualquier persona que incumpla los términos de este párrafo.
NTN EUROPE no podrá ser considerado responsable de ningún error u omisión que pudiera haberse producido en este documento a pesar del cuidado puesto al redactarlo. Debido a nuestra política de investigación y desarrollo continuos, nos reservamos el derecho a introducir cambios sin previo aviso en todos o en parte de los productos y especificaciones mencionados en este documento.
© NTN EUROPE, international copyright 2023.

NTN Europe - 1 rue des Usines - 74000 Annecy
RCS ANNECY B 325 821 072 - Code APE 2815Z - Code NACE 28.15
www.ntn-snr.com

NTN

SNR

BCA
BEARINGS

BOWER

Brands of
NTN corporation