



Brand of **NTN corporation**

DRIVE BOOSTER NEW GENERATION

The best single-point lubricator to simplify your maintenance and optimise your productivity



DRIVE BOOSTER, lubrication tailored to your needs

A key point for your equipment

Only adequate lubrication can ensure the optimum operation of bearings and associated mechanical assemblies. **55% of premature bearing failures** are due to inadequate lubrication.

Excessive grease

- Increase in operating temperature
- Deterioration of grease in high-speed bearings
- Sub-optimal use of fresh grease
- Contact seals may be damaged

Insufficient grease

- Premature wear
- Accelerated breakdown of remaining grease
- Risk of contaminant ingress due to lack of lubricant drain

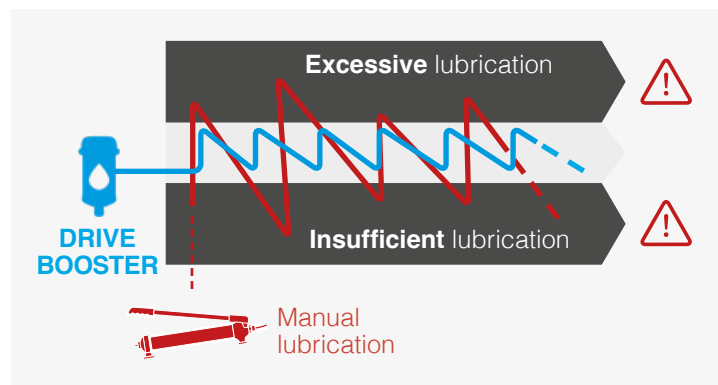

Automatic lubricator ensures constant lubrication of your bearings. The lubricator is easy to integrate and helps to optimise lubrication without you having to modify your installation.



Automatic lubricators: why and where are they needed?

Prevent contamination of bearings

DRIVE BOOSTER installation points

- a. Bleeding the pump seal
- b. Relubrication and bleeding of the conveyor bearing seal
- c. Bearing lubrication with seal purge

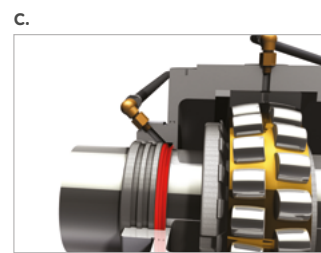
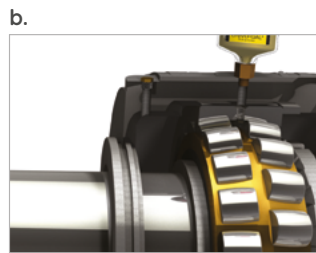
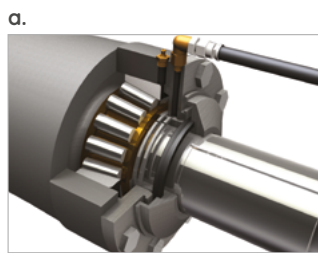

Offering greater safety

- a. Remote lubrication systems for bearings which are installed behind a screen to ensure operator safety
- b. Automatic relubrication equipment for confined or high spaces where authorisation may be required
- c. Ground-level lubrication systems for hard-to-reach equipment such as motors, fans or large electric pumps

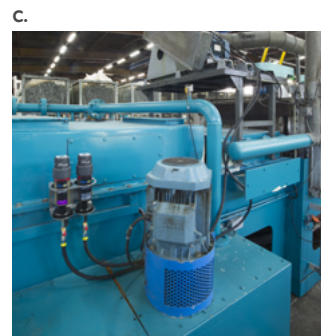
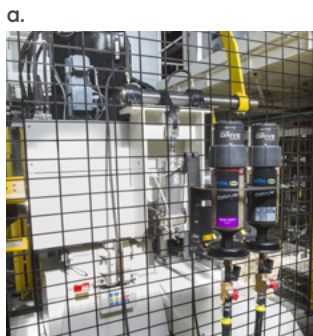

Selection guide

4 simple steps to choosing a lubrication solution

1

Study of the type of **application** or equipment

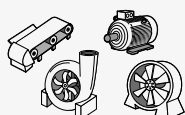

2

Choice of **installation** method

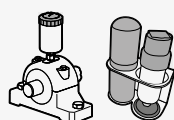

3

Choice of **lubrication solution** and type of lubricant

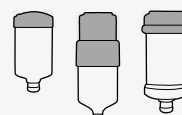

4

Selecting the **kit**

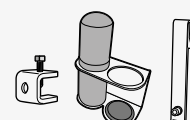

DRIVE BOOSTER, new generation

Unique expertise

All our expertise in bearing lubrication at the service of your equipment.

We offer you a unique combination of tried and tested lubricants for our various bearings with what is arguably the best single-point automatic lubricator on the market.

We offer a wide range of lubricants perfectly suited to each of your applications.



Safety at work

Significant reduction in the risk of accidents.

Particularly suitable for remote mounting, the DRIVE BOOSTER avoids direct contact between man and machine, making a significant contribution to increasing safety in the workplace.

- Reduced presence in dangerous areas that are difficult to access
- Reduced risk of accidents due to lubricant on the floor
- DRIVE avoids direct contact with lubricants that are harmful to health

Simplify and optimise your maintenance

Managing lubrication with DRIVE will make your equipment more reliable and free up time for other operations.

- Easier to implement than a centralised lubrication system
- More reliable than manual lubrication and, above all, less risky for the operator
- Grease distribution for up to 24 months without intervention
- Large refill capacity: up to 500 cm³

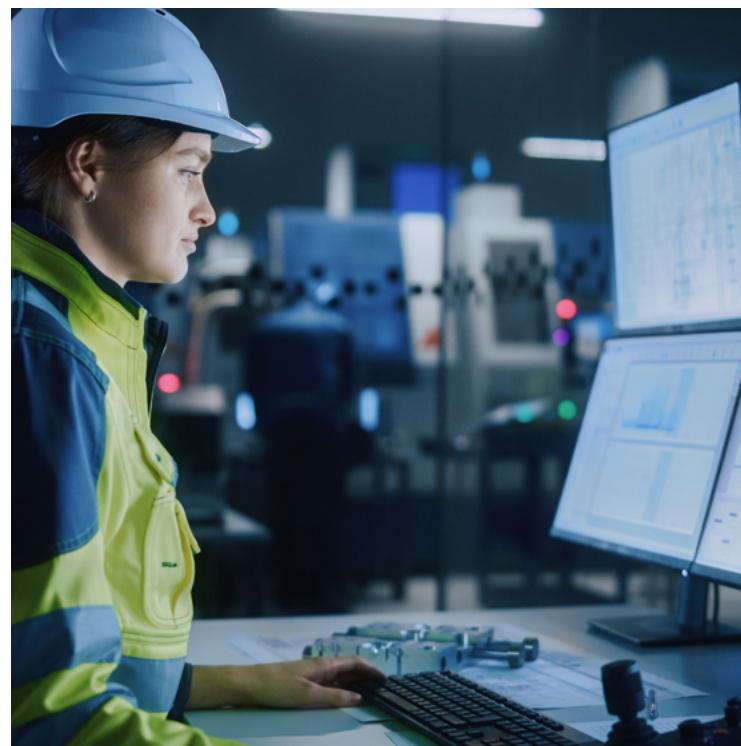



Profitability and economy

Cost savings of up to 25%.

Constant automatic lubrication minimises premature wear and downtime.

- High plant availability: remote mounting means cartridges can be changed without stopping the machine
- Reduced unforeseen repair and maintenance costs
- One-off acquisition costs for the DRIVE motor

Environmental protection

Our eco-responsible commitments at the service of our offer.

The right amount of lubricant for the right application reduces lubricant consumption. Reusable, environmentally-friendly components help reduce energy and material costs in your business.

- **NTN's** environmental management system has been ISO 14001 certified for many years
- Lubricant consumption is reduced by dosing according to requirements
- No risk of lubricant pollution
- Reusable control head minimises energy and hardware costs



Product features



- **Operating pressure of 7.5 bar:** enables remote mounting up to 5 m
- Operating temperature: **-20 °C to +60 °C**



- Installation outside hazardous areas or in accessible locations to increase safety in the workplace
- Higher plant availability because replacement can take place during operation
- Universal use for high and low temperatures



- **LCD display with setting button** indicating dispensing time, cartridge size and operating status
- Reusable **electromechanical motor** with battery pack



- Very easy to use
- Precise adjustment to suit requirements, preventing over- or under-lubrication
- Settings can be changed at any time
- Accurate, reliable lubricant distribution, independent of temperature and back pressure
- One-off acquisition costs for the DRIVE motor



- Refills available with different greases in **60cc, 120cc, 250cc et 500cc**



- Adapting the cartridge as closely as possible to your needs
- 4 sizes available with different greases > compatible with all our mounting kits

Technical data

Distribution time

Refill 120 and 250: 1 to 12 months or 1 to 26 weeks
Refill 60: 1 to 24 months
Refill 500: 6 months maximum

Volume of lubricant

60 cm³, 120 cm³, 250 cm³ or 500 cm³
2.03 oz, 4.06 oz, 8.45 oz or 16.91 oz

Operating temperature

-20 °C to +60 °C

Constant pressure build-up

Up to 7.5 bar / 109 psi

Protection class

IP 67 / IP 65

Standard and special lubricants

Greases up to NLGI 2 / oils

Lubricator structure

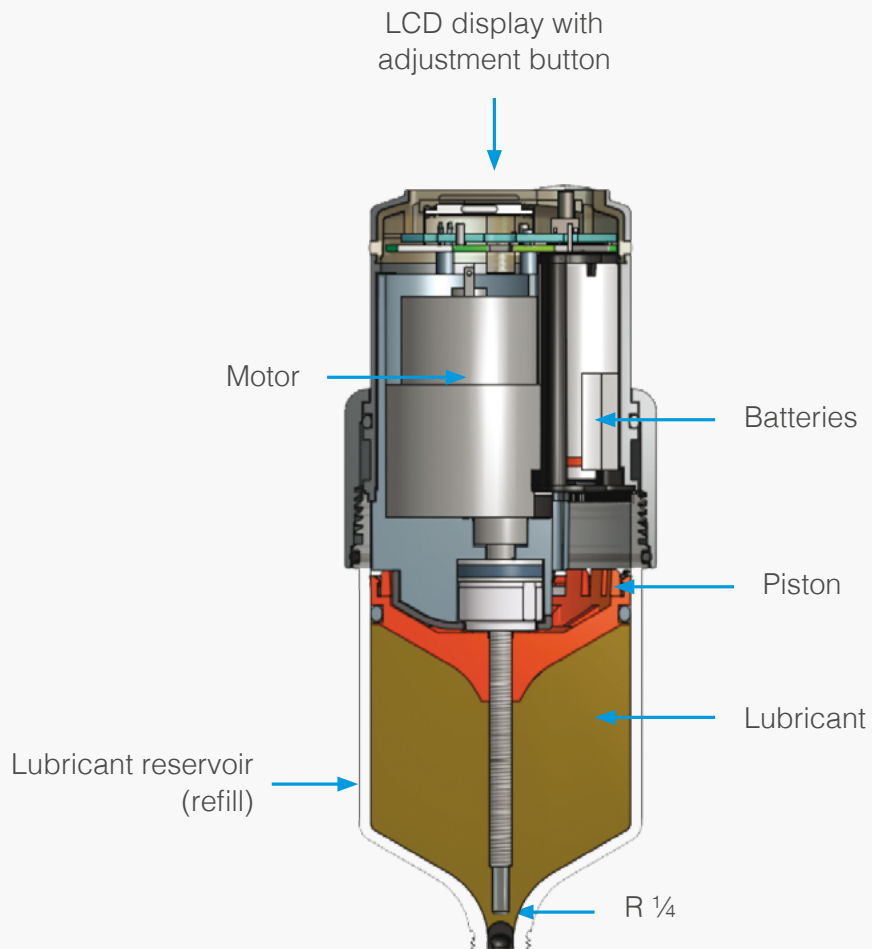

Refill dimensions

- 60 : Ø 75 x 155 mm
- 120 : Ø 75 x 178 mm
- 250 : Ø 75 x 228 mm
- 500 : Ø 75 x 324 mm

First order



Refill



For which applications?

The technical features and benefits of the DRIVE BOOSTER allow installations on a large number of applications. A wide range of lubricants is available for the various refills.

Applications particularly suited to the use of DRIVE BOOSTER

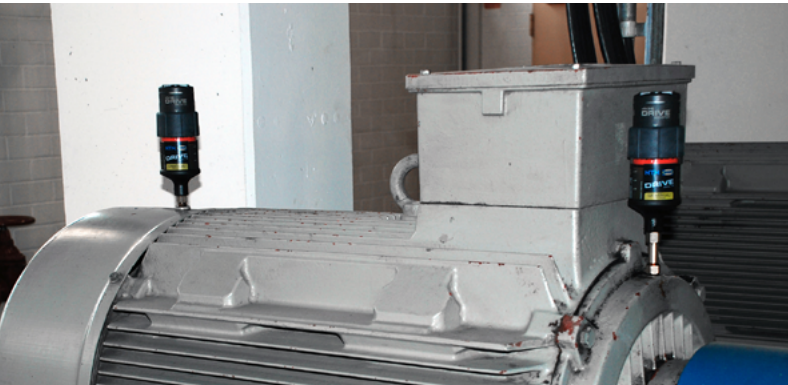

Power station
Application: electric motors



Quarrying
Application: belt conveyors





Automotive industry
Application: fans

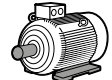

Mining
Application: slurry pumps

For your application

	 Conveyors	 Electric motors	 Pumps	 Blowers / fans
Standard load grease				
SNR LUB UNIVERSAL +		•		•
SNR LUB FOOD	•			
Multi-purpose grease (extreme pressure greases)				
SNR LUB HEAVY DUTY +	•	•	•	
SNR LUB HIGH TEMP MP		•		•
SNR LUB VIB				•
Multi-purpose oil				
SNR LUB CHAIN OIL	•			
SNR LUB FOOD CHAIN OIL	•			

Other greases available on request.
Recommendations given for guidance only. Grease to be adapted to each application. Please contact your dealer for any recommendations.

Remote mounting kits

Combined with our mounting kits, our DRIVE BOOSTERS offer a complete solution that allows you to install your automatic lubricator in the blink of an eye.

Remote installation or not?

Very often, it is safer to install remote lubrication systems because of the risks caused by access to machines in operation.

When to opt for a remote installation:

- Protective barriers or safety cages must be removed to gain access to the lubrication point
- Access to the lubrication point is difficult or dangerous while the equipment is operating
- The lubrication point is subject to intense vibrations or high temperatures that could damage the lubrication system
- A permit is required for access to lubrication points, such as those located in confined spaces or at height
- The lubrication point is exposed to excessive quantities of water, treated materials or impacts from solid materials



Drive mounting kits advantages



Safety at work

- Reduces the risk of accidents by 90%
- Reduced time spent in hard-to-reach hazardous areas
- Our remote mounting kits are subject to high safety standards



Costs

- The best economic solution with a cost advantage over retail purchasing
- All parts from a single supplier for less administration



Reliability

- All our kits have been designed on the basis of long experience to meet our customers' challenges
- The robustness of each accessory ensures a long service life

DRIVE Standard Duty mounting kits

Standard Duty mounting kits are designed for use in environments with normal environmental conditions. The kits contain the necessary fixing materials and an M10x1 and G1/8 reducer for each lubrication point.

Fixing with bracket



1 point with 65 mm fixing bracket and 3 m hose.

SNR reference:
LUBER SDKIT 1P BC



2 points with 65 mm fixing bracket and 5 m hose.

SNR reference:
LUBER SDKIT 2P BC

Fixing for protective grille



1 point for protective grille with 3 m hose.

SNR reference:
LUBER SDKIT 1P CH



2 points for protective grille with 5 m hose.

SNR reference:
LUBER SDKIT 2P CH

DRIVE Heavy Duty mounting kits

DRIVE Heavy Duty mounting kits are designed for use in environments with harsh environmental conditions. The kits contain the necessary fixing materials as well as a DRIVE Heavy Duty protective cover, a drain connection with manual valve and an M10x1 and G1/8 reducer for each lubrication point.

Fixing with bracket



1 point with 65 mm fixing bracket and 3 m hose.

SNR reference:
LUBER HDKIT 1P BC



2 points with 65 mm fixing bracket and 5 m hose.

SNR reference:
LUBER HDKIT 2P BC

Fixing for protective grille



1 point for protective grille with 3 m hose.

SNR reference:
LUBER HDKIT 1P CH



2 points for protective grille with 5 m hose.

SNR reference:
LUBER HDKIT 2P CH



Discover our **complete**
range of lubrication
solutions on our website
www.ntn-snr.com



DOC_L_DRIVEBOOSTER_ARG1_A4_GBa - CODE SAP 688208 - Document non contractuel - NTN copyright international - 07/23 - Photos : NTN - Pedro Studio Photos

NTN

Make the world **NAMERAKA**

This document is the exclusive property of NTN Europe. Any total or partial reproduction hereof without the prior consent of NTN Europe is strictly prohibited. Legal action may be brought against anyone breaching the terms of this paragraph. NTN Europe shall not be held liable for any errors or omissions that may have crept into this document despite the care taken in drafting it. Due to our policy of continuous research and development, we reserve the right to make changes without notice to all or part of the products and specifications mentioned in this document.
© NTN Europe, international copyright 2023.

NTN Europe - 1 rue des Usines - 74000 Annecy
RCS ANNECY B 325 821 072 - Code APE 2815Z - Code NACE 28.15
www.ntn-snr.com

NTN

SNR

BCA
BEARINGS

BOWER

Brands of
NTN corporation