

CLAS[®]
GARAGE SOLUTIONS



BRAND OF NTN CORPORATION

An offer of tools dedicated
to professionals.
Approved by SNR.





SUMMARY

PRESENTATION

CLAS offer	3
SNR offer	4
Partnership	5

FRAME

Wheel bearing and transmission	6
Suspension	15

POWERTRAIN

Distribution servers	20
Wedging boxes and accessories	22
Specific timing tools 1.2 Puretech	54

WORKSHOP SOLUTIONS

GLOBAL SOLUTIONS

To offer a complete solution, our ranges allow to equip a workshop completely.
From the small screwdriver to the elevator.

EQUIPMENTS

Lifts ramps	Heaters
Wheel balancers	Tire changers
Air pipe fitting	...

GENERAL TOOLS

Lifting	Lighting
Reels	Pneumatic tools
Presse	...

HAND TOOLS

Screwing	Socket & Ratchet
Tightening keys	Torque wrenches
Hammering tools	...



VEHICLE SOLUTIONS

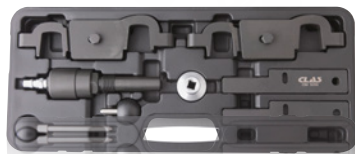

THE HEART OF OUR BUSINESS

All the specific tools related to the automotive repair (LV, LCV and HGV), gathered in 3 poles:

MECHANIC

From quick interventions such as braking or draining to more complex ones such as engine or gearbox timing.

HYBRID & ELECTRIC

A whole range of insulated tools and protective products (clothing, signs) for new generation vehicles.

BODY REPAIR

A special profession that requires adapted products.

TRUCKS

A SPECIFIC RANGE

In addition to the hand tools and its 1" sockets, the specific tools for the extraction of the hubs PL, the impact wrenches... CLAS also offers a whole range of hub and brake caliper supports.

The idea?

To reduce MSD disorders and accidents related to the handling of heavy parts.

All these products can be found in our truck catalog.



FRAME



WHEEL / More than 1500 references

- 98% of the European car park is covered
- Wheel bearing R1###.##
- Brake discs KF###.##
- Wheel bearing sensors ASB###.##

CVJ / More than 470 references

- 2nd largest OE manufacturer in the world
- Complete driveshafts DK###.###
- 1/2 driveshafts wheel side OJK###.###
- 1/2 differential-side transmission IJK###.###
- Boot kits wheel side OBK###.###
- Boot kits differential side IBK###.###

"In partnership with CLAS, we offer a range of tools "Approved by SNR": a dedicated tool range for wheel bearings and transmissions."



SUSPENSION / More than 500 references

- 30 millions struts bearings manufactured per year
- Suspension kits KB###.##
- Rear suspension arm kits KS###.##
- Strut bearing M###.##
- Strut bushes KBLF###

TIMING / More than 1 200 references

- 98% of the european car park is covered
- Partner to world vehicle manufacturers
- Timing kits with or without water pump KDP/ KD###.###
- Timing chain kits KDC###.##
- Tensioners GE/GT###.##

AUXILIARY / More than 1700 references

- 96% of the european car park is covered
- Belts CA#PK###
- Pulley accessories GA3###.##
- Accessory kits KA###.##
- Damper pulleys (with or without bolt) DPF###.##/ DPF###.##K1
- Overrunning alternator pulley GA7###.##

AIR CONDITIONING / 24 references

- Cover a large part of the air conditioning market
- Air conditioning bearing ACB###

POWERTRAIN



A range of dedicated tooling is also available for our suspension and distribution ranges.



DRIVELINE / TRUCK



GEARBOX / 250 references

- Covers 150 types of gearboxes
- Gearbox bearing ###.##

CLUTCH / 45 references

- A range designed and manufactured by NTN-SNR
- Clutch release bearings BAC###.##

TRUCK - WHEEL & GEARBOX / 290 references

- Wheel bearings (hub et tapered) HDS### / HDB###
- Gearbox bearing



BRAND OF **NTN CORPORATION**

CLAS[®]
GARAGE SOLUTIONS

CLAS & NTN : a technical partnership for automotive professionals

As an original equipment manufacturer of automotive parts, the NTN group develops and manufactures high quality and precision products. The range of SNR branded replacement parts have the same quality requirements as our OE products.

Changing a wheel bearing, suspension part, CV joints and timing belts kits can be a difficult job to carry out correctly.

Awareness is needed to support and train professionals in the automotive market, NTN Group is expanding its range with a selection of services and products. Some SNR products require specialist tools to carry out there fitment correctly.

For these specilist NTN SNR relies CLAS for its technical know-how and its expert manufacturing of tools.

Mechanics tools. Nearly one hundred references in our range that have been developed jointly with CLAS Tested and approved under the SNR brand.

This range covers all of the products by NTN Europe.

- POWERTRAIN (timing range),
- FRAME (wheel bearing range, CVJ and suspension)



Within the tool range, we offer customised SNR tool trolleys, fully equipped with tools specially selected for work on SNR branded products.

Buying quality parts is essential. Ensuring a quality fitment using the correct tools, helps to guarantee the satisfaction of your customer on completion of the work SNR and CLAS have built this partnership to be at your side every day !!

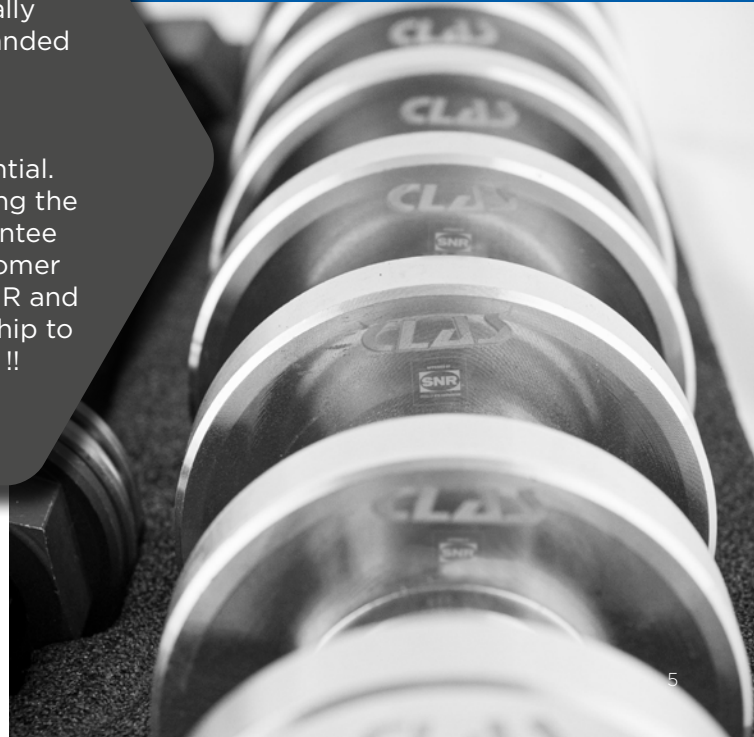

FRAME

TRANSMISSION & WHEEL BEARING

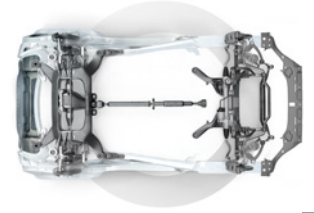

TN

OM 0199

WHEEL BEARING & CV JOINT OPERATIONS ROLLER CABINET

Specifically designed in partnership with the manufacturer NTN-SNR, in order to assure the right intervention methods to secure the installation, without affecting the technical specifications of the parts in accordance to the manufacturer.

This roller cabinet can be used for numerous bearing replacement operations, both multi-brand and with specific applications, and ergonomic workstation design (transmission and bearings), for applications close to the transmission.



Contents:

OM0024 : 1 x 1/2" d. hexagonal hub socket wrench d. 24mm vag
OM0156 : 1 x 3/4" d. double hex socket ø56mm ford transit
OM0001 : 1 x 6 pin rear hub socket lcv ø67.5mm
OM9264 : 1 x 4 pcs spline 1/2" d. xzn bit set m12-m14-m16-m18 1.78mm
OM0025 : 1 x thin hub wrench hex 1/2" 36mm
OM0055 : 1 x double hex impact socket ø35mm 1/2" 1.85mm
OM7069 : 1 x 1/2" impact socket bit set hub and cv joint (8 pcs)
OM2555 : 1 x lower ball joint hex socket psa 41mm 1/2" d.
OM7146 : 1 x 46mm 1/2" double hex socket
OM2515 : 1 x lower ball joint removal socket 6-sided 27 mm 1/2"
OM2655 : 1 x 4 pin ball joint socket mercedes m class
OM2544 : 1 x 1/2" psa ball-joint hex. socket 44mm
OM2605 : 1 x lower ball joint socket psa ø52mm
OM0779 : 1 x torque wrench 1/2"d. 42-210nm 461mm
OM0780 : 1 x torque wrench 3/8" d. 5-50nm
OM9396 : 1 x cv boot clamp plier with double grip
OM8021 : 1 x transmission puller fork renault
OM8024 : 1 x ring pliers+4 shells
OS5105 : 1 x internal/external circlip pliers
OM8026 : 1 x cutting pliers for cardan bellows
OM0136 : 1 x pliers spreader cardan shaft joint ring
OM8028 : 1 x extension rod set
OM8031 : 1 x drive shaft/cv joint set-up set
OM8032 : 1 x driveshaft/shield puller set
OM4217 : 1 x 8 hub disc set-up socket set
OM8033 : 1 x inner bearing removal set
OM8034 : 1 x universal bearing removal set
OM8035 : 1 x aluminum hub bearing removal set
OM8036 : 1 x 2nd generation tool bearing removal ø62-85mm
OM8037 : 1 x hydraulic ram 17t stroke 43mm
EG009INTN : 1 x ntn/snr 6 drawers roller cabinet
SA3423 : 1 x hydraulic ram

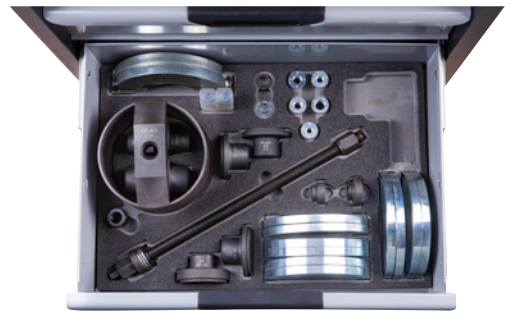

Contents:

- drawer 1: hub socket insert, 1/2" torque wrench
- drawer 2: pliers insert, 3/8" torque wrench, specific tools
- drawer 3: OM 8033 inner bearing removal set, OM 4217 hub disc set-up socket set
- drawer 4: SA 3423 hydraulic ram, OM 8028 extension rod set, OM 8032 driveshaft/shield puller set, OM 8031 driveshaft/shield set-up set
- drawer 5: OM 8034 universal bearing removal set, OM8035 aluminum hub bearing removal set
- drawer 6: OM 8036 2nd generation tool bearing removal, OM 8037 hydraulic ram

SNR PRODUCTS

Wheel bearing kit R



Brake kit with integrated bearing KF



Transmission range

OBK



IBK

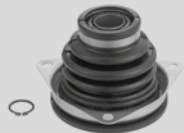

OJK



IJK



DK

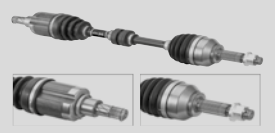

SNR PRODUCTS - Transmission range

OBK	IBK	OJK	IJK	DK

OM 0136

PLIERS SPREADER CARDAN SHAFT JOINT RING

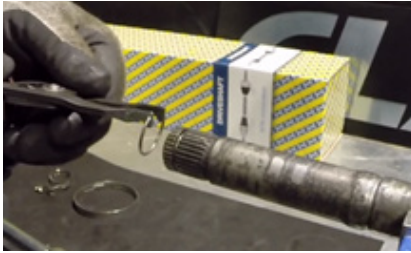

TN

5
WARRANTY

OM 0780

TORQUE WRENCH 3/8" D. 5-50Nm

Delivered with calibration certificate



Specifications:

- calibration certificate
- 24 teeth
- torque: 5-50Nm
- drive: 3/8"
- dimensions: L.333mm
- weight: 0.465Kg

TN

2
WARRANTY

OM 0792

TORQUE WRENCH 1/2" 40-220Nm

Delivered with calibration certificate



TN

2
WARRANTY

OM 8021

TRANSMISSION PULLER FORK
RENAULT

Accessory for OM 4022

Specifications:

- L.210xW.87xH.65mm
- Ø: 18mm
- thread: 150

Applications:

- Renault Kangoo, Megane
- Dacia



TN

5
WARRANTY

OM 8024
RING PLIERS+4 SHELLS

Locking pliers supplied with 4 sets of interchangeable clamps for tightening the snap ring on the transmission shaft to reinstall the seal (bowl) on the transmission when using the SNR OBK (Outer Boot Kit) and OJK (Outer Joint Kit) types



Safe operation, no risk of rush damages



Suited for splines:
 Ø23,8mm 29 teeth
 Ø24,6mm 30 teeth
 Ø26,97mm 33 teeth
 Ø28,57mm 35 teeth

These shells cover about 80% of the park.

OM 8026
CUTTING PLIERS FOR CARDAN BELLOWS

OM 9396
CV BOOT CLAMP PLIER WITH DOUBLE GRIP

Enables the tightening of CV boot clamps when torquing is necessary.

Patented head, 2 pinch lines for positioning the plier either parallel or perpendicular to the CV boot according to the bulk and the space available on the vehicle.

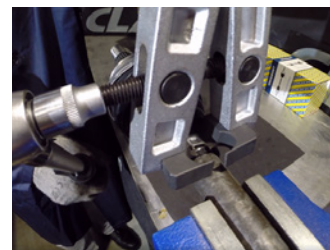

2 in 1 head



OS 5105

INTERNAL/EXTERNAL CIRCLIP PLIERS

Max. opening: 75mm

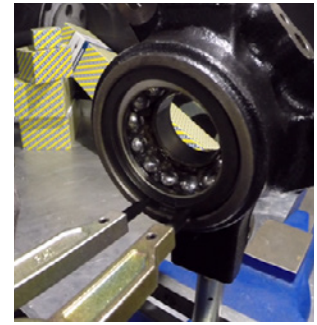

Specifications:

- simple to adjust using the 3/8" screw
- 12 pairs of interchangeable end-fittings:
 - straight: 2.5, 3.0, 3.5, 3.8mm
 - 45° angled: 2.5, 3.0, 3.5, 3.8mm
 - 90° angled: 2.5, 3.0, 3.5, 3.8mm
- length: 305mm
- max. opening: 75mm



TN

OM 4217

8 HUB DISC SET-UP SOCKET SET

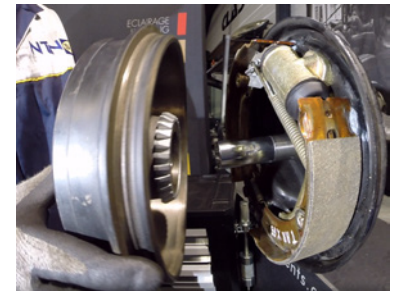

Mounting aid sleeves for wheel bearings integrated in the brake disc or drum.
Without guidance during assembly, the bearings may deteriorate on the wheel spindle, in case of insertion problems, removal will cause irreparable damage to the biconical bearing.
After choosing the right sleeve, insert it on the thread of the wheel fuse, this one will allow to keep the alignment when inserting the disc or drum equipped with the bearing.

Fast, secure assembly



TN

OM 8033

INNER BEARING REMOVAL SET

This assembly allows for quick and easy removal of the inner ring from the bearings without damaging it.
When removing the hubs, the rings remain in their housings and without special tools it is not possible to remove them without risk of damage.

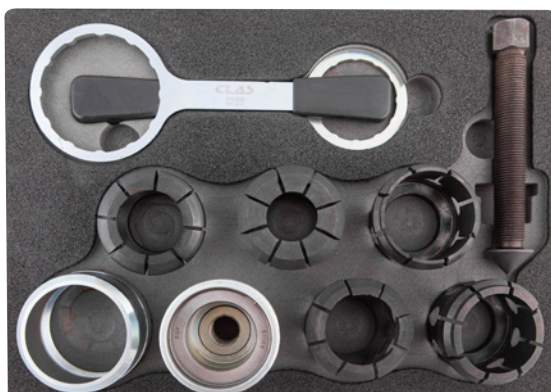

1/2 drawer format



This set can be used to replace rings from Ø35 to Ø61mm.

Contents:

- 5 clamping rings from Ø35 to Ø61mm.
- 1 bowl to receive the rings
- 1 M22 thrust screw with 24mm hex drive



TN

OM 8032
DRIVESHAFT/SHIELD PULLER SET

To remove wheel hubs, this product is designed to remove stuck and bent drive shafts, in advanced cases it can be used with a hydraulics power bolt (optional). Suitable for hubs with wheel studs or bolts.

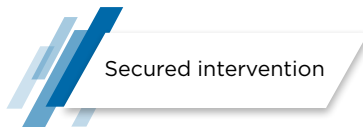

1/4 drawer format

Specifications:

- plate: slotted mounting hole M12 and M14
- working range: M12: Ø96-138mm - M14: Ø98-136mm

Applications:

Multi-brand

OM 8028
EXTENSION ROD SET
Accessory for OM 8032

This kit aims to remove drive shafts and wheel hubs, using a plate provided with an inertial mass or hydraulic ram.

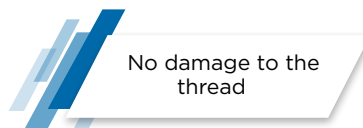
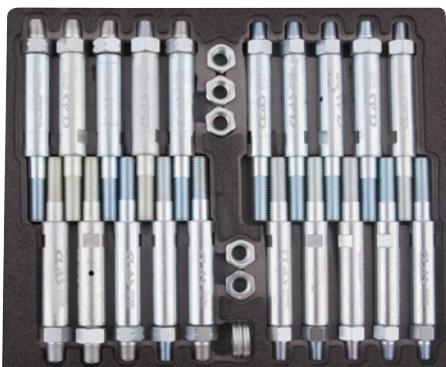

1/2 drawer format

Contents:

- 4 sets of 5 offsets of 80mm for hubs, nuts and bolts: M12/M14/M16/M18

Applications:

Suitable for male or female threaded hubs. Multi-brand, especially LCV and 4X4.

OM 8031
DRIVE SHAFT/CV JOINT SET-UP SET
Accessory for OM 8032

With the help of sockets or nuts specially shaped to fit on the transmission, a traction screw locked at its end will allow the steering of the transmission in the hub.

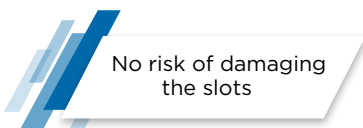

1/4 drawer format

Fast and precise set-up

Applications:

Multi-brand



SA 3423

HYDRAULIC RAM

Spare part for OH 0327/OH 5020/OH 5022/OM 3423/
OM 3615/OM 2513/OH 0569



OM 8034

UNIVERSAL BEARING REMOVAL SET

This tooling is dedicated to bearings that are not integral within the hub. The design of the cups ensures a precise alignment.

This kit is designed for an intervention on the vehicle. It is also possible to add a 17T hydraulic power as an option or to use cups with the press.

This composition can also be used to remove some silent-blocs.



1/2 drawer format

Contents:

- 10 push cups from 61mm to 83,5mm
- 3 through cups 72, 80, 88mm
- 1 counter bearing cup
- 1 traction screw M20 with bearing
- 2 thrust screws M12x1,5
- 2 thrust screws M14x1,5



OM 8035

ALUMINUM HUB BEARING REMOVAL SET

This kit has been specially developed to remove hubs and bearings on VAG type multi-arm wheel shafts.

Applicable for dual compact bearings where the hub and then the bearing need to be removed.

Removal of the steering stub is not necessary!



1/2 drawer format

The steel bearing is usually extremely tight in the aluminum axle barrel, which makes the removal extremely difficult. When using the inertial hammer, there is a risk of damaging the suspension parts. In addition, micro-cracks on the aluminum frame can cause breaks. Using this special tool, components can be carefully removed directly from the vehicle.

The tool's features include
- removal of bearings
- installation and removal of hubs

Applications:

- Audi: A4 (2000-), A5 (2007-), A6 (1997-), A7 (2010-), A8 (1994-), Q5 (2008-), R8 (2007-)
- Seat Exeo (2008-)
- VW Passat (2003-)



OM 8036
**2nd GENERATION TOOL BEARING
REMOVAL Ø62-85mm**

Installation and removal directly on the vehicle.
No shock absorber removal, no suspension arm removal, no camber adjustment on some vehicles.

Applications:

Ø62: Audi (A1, A2, VW Lupo...)
Ø66: Seat (Cordoba, Ibiza...), Skoda (Fabia...), VW: (Fox, Polo 7-8...)
Ø68: PSA, Renault...
Ø72: Audi (A1, A2 (ABS)...), Seat (Cordoba, Ibiza...), Skoda (Fabia, Roomster...), VW (Fox, Polo 7-8...)
Ø75: Mitsubishi (Colt...), Smart (Forfour...)
Ø78: Volvo (C30, C70, S40 2, V50...), Ford (C Max, Focus 2, Mazda 3...)
Ø82: VW (Touareg...), Porsche (Cayenne...)
Ø85: VW (T5)

Contents:

To set up:

- 1 set of half-shells for Ø62mm
- 1 set of half-shells for Ø66, 68mm
- 1 set of half-shells for Ø72, 75, 78mm
- 1 set of half-shells for Ø82, 85mm

To remove:

- 1 set of half shells for Ø62, 66, 68, 72, 75, 78, 82, 85mm



Format 1 full drawer



Time saving

OM 8037
HYDRAULIC RAM 17T STROKE 43mm
Specifications:

M20 through-body ram.
- force: 17 tons
- stroke: 43 mm
- dimensions: Ø90x155mm
- max. pressure 700bar
- connection: 3/8" 18 NPT
- external connection thread: 2" 3/4-16 UN
- material: aluminum
- reducers: M10, M12, M14, M16, M18



OM 8154

PISTON PUSHER SET (22 PCS)

Applications:

- 0: General Motors
- 1: General Motors, PSA
- 2: Citroën, Honda
- 3: Alfa Romeo, Audi, Austin, BMW, Ford, Honda, Jaguar, Mercedes-Benz, Mitsubishi, Nissan, PSA, Rover, Toyota, VW
- 4: Alfa Romeo 164 2.0, Ford, Mazda, Saab 9000, Subaru
- 5: Adaptateur 3/8
- 6: Nissan Primera, VW Golf IV
- 7: Audi 80 /90/V8/100, Ford Sierra ABS/Scorpio AB85, Honda Prelude, Nissan Silva 1.8T, Rover 8000, Saab 9000, Subaru L+Z, VW Golf+Passat
- 8: General Motors
- 9: General Motors
- 10: Iveco

- a: Renault
- e: Nissan Maxima
- f: Opel Astra
- k: Citroën
- k1: Citroën C5 (front caliper)
- k2: Audi
- m: Ford
- n: Saab, Honda
- o: Citroen C3, C5, Xantia, ZX, XM



OM 8027

WHEEL BEARING CIRCLIPS PLIERS GEN1

Specially designed to extract internal circlips without installation/removal lugs. These circlips are mainly found on the wheel bearings.

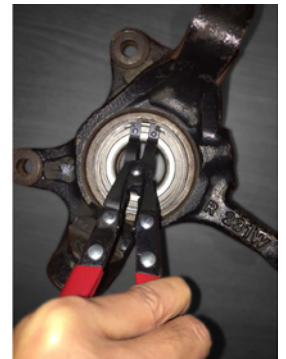

Max. opening: 41mm

Renault, Peugeot, Citroën, Toyota, Lexus, Nissan



OM 0022

9KG INERTIAL MASS WITH SHOCK ABSORPTION GEN1

Accessory for OM 0199/OM 9208

Designed for the extraction of the most recalcitrant parts, e.g. constant velocity joint (transmission bowl), hubs, as well as for many bodywork straightening jobs.

Due to the technical nature of the mass, it will prevent it from rebounding when struck.

The intensity of the impact is considerably reduced, because the effort will be transmitted directly to the struck element. This will bring a comfort of work to its user.

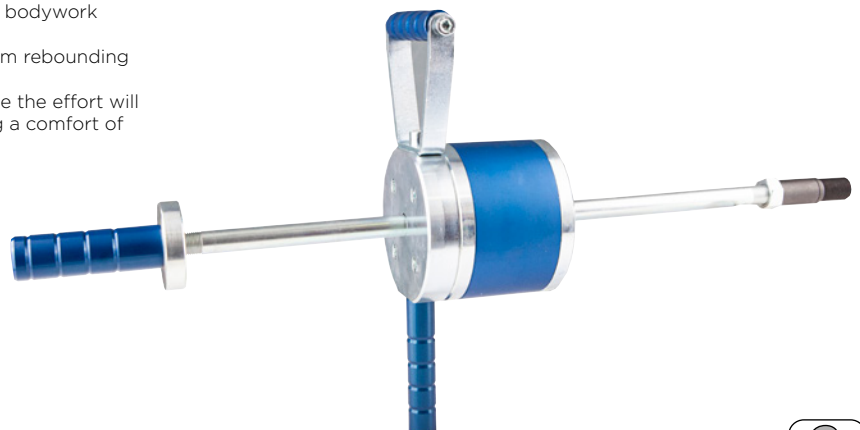
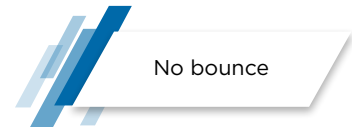

Specifications :

- weight 9 Kg
- total length 770 mm
- adapter thread M18 x 1.5 / M22 x 2.0



FRAME

SUSPENSION

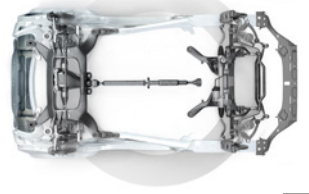

TN

SNR PRODUCTS - Transmission range

KB	KBLF	M

OM 1112

SHOCK ABSORBER HEAD REMOVAL KIT

This kit is specially designed for installing and removing shock absorber heads. Its go-through socket wrench lets you release or tighten the top cup nut while holding the damper piston steady to prevent it turning.



Contents:

- SA1132: ratchet wrench with loops 21mm
- SA1163: hex go-through socket 16mm L.82mm 1/2"
- SA1164: hex go-through socket 17mm L.82mm 1/2"
- SA1165: hex go-through socket 18mm L.82mm 1/2"
- SA1166: hex go-through socket 19mm L.82mm 1/2"
- SA1167: hex go-through socket 21mm L.82mm 1/2"
- SA1168: hex go-through socket 22mm L.82mm 1/2"
- SA1169: hex go-through socket 24mm L.82mm 1/2"
- SA1170: hex socket bit 6mm L.123mm 1/2"
- SA1171: hex socket bit 7mm L.123mm 1/2"
- SA1172: hex socket bit 8mm L.123mm 1/2"
- SA1173: hex socket 7mm L.123mm 1/2"
- SA1174: hex socket 8mm L.123mm 1/2"
- SA1175: hex socket 9mm L.123mm 1/2"
- SA1176: torx socket bit T50 L.123mm 1/2"
- SA1177: slotted socket bit 5x8 L.123mm 1/2"
- SA1178: slotted socket bit 6x8 L.123mm 1/2"
- SA1179: slotted socket bit 7.1x9.6 L.123mm 1/2"



OM 9272

TOOL FOR SPACING STRUTS OR WHEEL TRIANGLES

Compatible with PSA, Renault, VW, Audi, BMW...

Specifications:

- alignment guides
- interchangeable spacing arrows



Ideal for double suspension ball joints



TN

OP 3221

REINFORCED PNEUMATIC SPRING COMPRESSOR WITH ARTICULATED JAWS

Specially designed to adapt to widely spaced loop springs and securely hold them in place. Thanks to the innovative articulation system, automatic adjustment takes place when the spring is compressed.

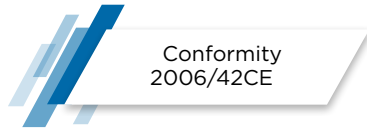

Specifications:

- height: 1600mm
- base: length: 847mm width: 628mm
- working pressure 6bar/max 10bar
- compression strength 2452kg
- use and maintenance instruction book.
- color: grey
- 2 position adjustable lower cup (e.g. Chrysler, Dodge RAM long travel shock absorber...)
- weight: 70kg

Contents:

- OP2003: articulated upper jaws
- SA6904: lower cup 125-205mm
- SA6916: reinforced lower cup 78-130mm
- SA6906: fall protection support



OP 3231
PNEUMATIC SPRING COMPRESSOR 3T

Specially designed to fit and securely hold coil springs wide apart. Thanks to the innovative articulation system, the adjustment is automatic when the spring is compressed.

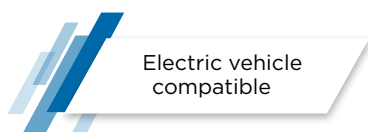

Electric vehicle compatible

Specifications:

- compression force: 3000kg
- stroke: 330mm
- operating pressure: 6bar/max. 10bar
- dimensions: H.1800xL.871xl.690mm
- operating and maintenance instructions
- conformity 2006/42CE
- weight: 110kg
- lower cup adjustable on 2 positions (ex: Chrysler, Dodge RAM long travel shock absorber...)
- equipped with wheels for easy movement
- protection grid lined with high resistance polycarbonate plexiglass

Contents:

- OP2003: articulated jaws
- SA6904: 1 cup Ø125 to Ø205mm
- SA6916: 1 cup Ø78 to Ø130mm
- SA6906: fall arrest support

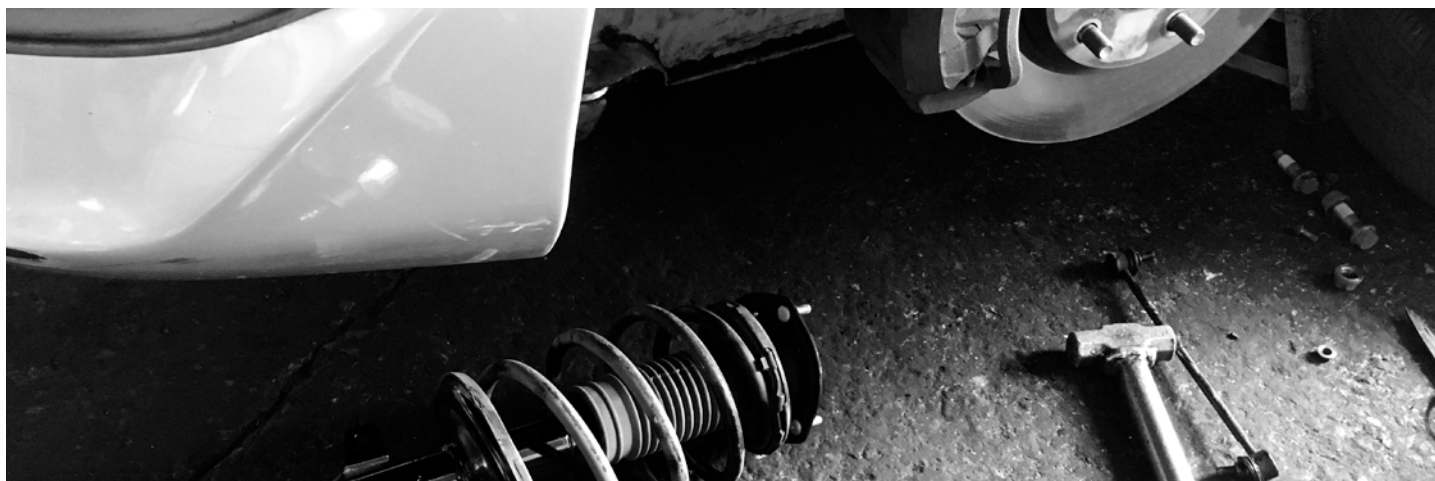

OP 3241

PNEUMATIC SPRING COMPRESSOR 4T

Specially designed to fit and hold McPherson shock absorber springs thanks to the innovative articulation system of the lower cup allowing the positioning of left or right angular spiral, it covers springs from Ø78 to Ø205mm.

This retractable cup also allows the locking by the strut in vice grip Ø75mm.

The spring is compressed by the positioning of 2 articulated jaws, mounted on 2 free arms which naturally follow the spring's turn.

Compatible with electric vehicles



Specifications:

- compression force : 4000kg
- stroke : 380mm
- integral protection grid lined with high resistance polycarbonate plexiglass
- pneumatic safety at the opening of the grid and at the pedal control
- working pressure : 8bar/maxi 10bar
- conformity 2006/42CE
- dimensions: H.1731xL.957xW.625mm
- weight: 110kg

Content:

- OP2003: articulated jaws
- SA6906: fall arrest support



OP 2004

CUP KADJAR/QASHQAI/
KOLEOS/JUKE

Accessory for OP 3221



TN

OP 2006

RED JAWS HONDA-TOYOTA

Accessory for OP 2031/OP 3221

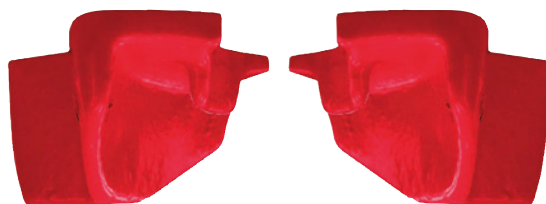

TN

OP 2008

CUP MERCEDES A, C, E
RENAULT MEGANE

Accessory for OP 2031/OP 3221



TN

OP 2009

CUP RENAULT MEGANE/
C3/STYLO

Accessory for OP 2031/OP 3221



TN

OP 2010

COMPRESSED
STRUT CLAMP

Accessory for OP 2031/
OP 3221/OP 3231



TN

OP 2018

COMPRESSED STRUT
VICE SPECIFIC
CHRYSLER/MERCEDES
VOYAGER

Accessory for OP 2031/
OP 3221/OP 3231



TN

OP 2027

CUP MERCEDES CLASS
C >2010

Accessory for OP 2031/
OP 3221/OP 3231



TN

OP 2028

CUP MERCEDES
CLASSE A,B,E

Accessory for OP 2031/
OP 3221/OP 3231

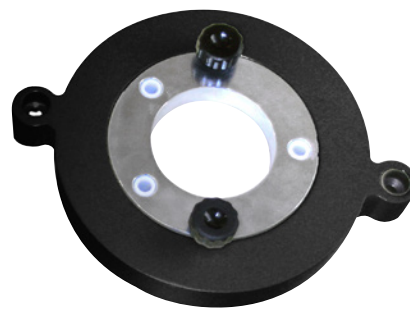

TN

POWERTRAIN

TIMING TOOLS ROLLER CABINET



Timing tools & accessories range

KD	KDP	KDC	KA	GA	CA

OM 9594

GENERATION 1+2 RENAULT/PSA TIMING TOOL 8 DRAWER ROLLER CABINET

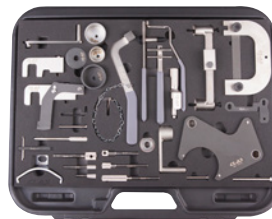

OM 6100



OM 6200



OM 6210



OM 6110

Contents:

- EG0098: 8 drawers tool roller cabinet
- OM6100: timing tools Renault/Nissan/Opel/Volvo
- OM6110: complete timing tool set recent Renault vehicles
- OM6200: timing tools PSA
- OM 6210: complete timing tool set recent PSA vehicles

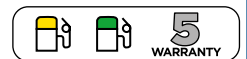

TN

OM 9695

RENAULT/PSA/FORD/VAG TIMING TOOL TROLLEY GENERAT°1+RNLT/PSA GENERAT° 2



OM 6100



OM 6200



OM 6200



OM 6110



OM 6210

Contents:

- EG0098: 8 drawers tool roller cabinet
- OM6100: timing tools Renault/Nissan/Opel/Volvo
- OM6110: complete timing tool set recent Renault vehicles
- OM6200: timing tools PSA
- OM 6210: complete timing tool set recent PSA vehicles
- OM6300: timing tools Ford/VAG

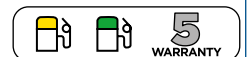

TN

OM 9799

MULTI-BRAND TIMING TOOL TROLLEY GENERATION 1

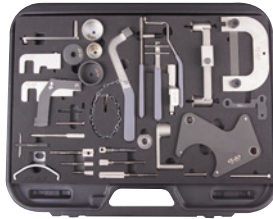

OM 6100



OM 6200



OM 6300

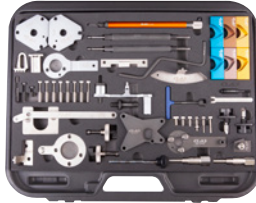

OM 6400



OM 6500



OM 6600

Contents:

- EG0098: 8 drawers tool roller cabinet
- OM6100: timing tools Renault/Nissan/Opel/Volvo
- OM6200: timing tools PSA
- OM6300: timing tools Ford/VAG
- OM6400: timing tools Fiat/Alfa/Lancia/Opel/Suzuki/Ford
- OM6500: timing tools Opel/Chevrolet/Saab/Fiat/Lancia/Suzuki/Ford
- OM6600: timing tools Ford/VW/Seat/Mazda/Volvo



OM 9901

MULTI-BRAND TIMING TOOL TROLLEY GENERATION 1 + RNLT/PSA GENERATION 2

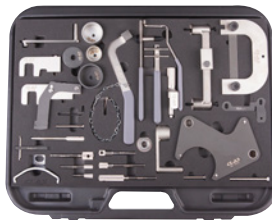

OM 6100



OM 6110



OM 6200



OM 6210



OM 6300

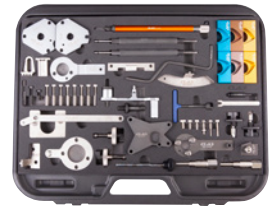

OM 6400

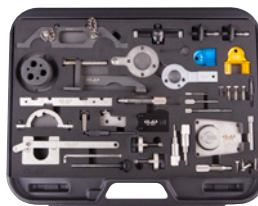

OM 6500



OM 6600

Contents:

- EG0098: 8 drawers roller cabinet
- OM6100: master timing tool set Renault/Nissan/Opel/Volvo
- OM6200: master timing tool set PSA
- OM6300: master timing tool set Ford/VAG
- OM6400: master timing tool set Fiat/Alfa/Lancia/Opel/Suzuki/Ford
- OM6500: master timing tool set Opel/Chevrolet/Saab/Fiat/Lancia/Suzuki/Ford
- OM6600: master timing tool set Ford/VW/Seat/Mazda/Volvo
- OM6110: complete timing tool set recent Renault vehicles®
- OM6210: complete timing tool set recent PSA vehicles®



POWERTRAIN

SET OF TIMING TOOLS AND ACCESSORIES



TN

OM 6100

MASTER TIMING TOOL SET RENAULT/NISSAN/OPEL/VOLVO GENERATION 1

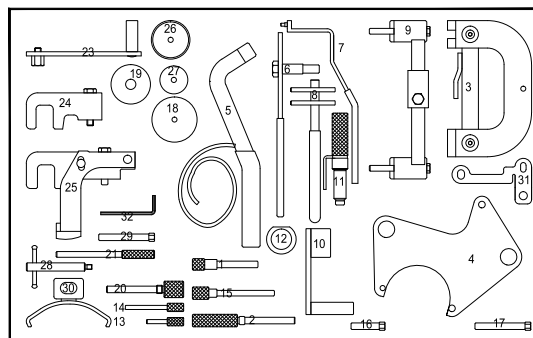
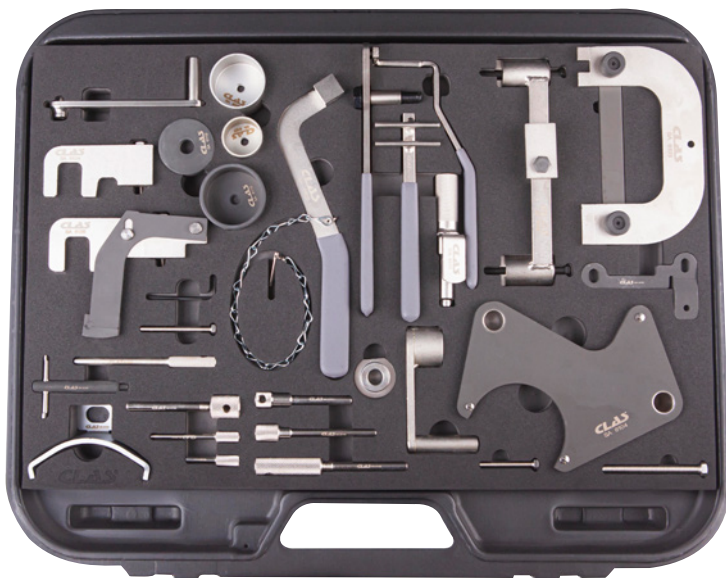

Models:

Renault: Clio 1-2-3-4, Clio Sport 1-2-3, Mégane 1-2-3, Master 1-2, Mégane Scénic 1-2-3, Vel Satis 1-2, Avantime, Kangoo 1-2-3, Laguna 1-2-3, Espace 1-2-3, Trafic 1-2, Wind, Modus, Twingo, Koleos

Dacia: Logan, Duster, Sandero, Dokker

Nissan: Note, Qashqai, Micra, Interstar, Primastar, Kubistar, Almera, Primera

Opel: Vivaro, Movano

Volvo: S 40, V 40

Engines: 1.2, 1.2 16V, 1.4, 1.4 16V, 1.5 DCI, 1.6, 1.6 16V, 1.6 D, 1.7, 1.8, 1.8 16V, 1.9 TD, 1.9 DCI, 1.9 DTI, 1.9 CDTI, 2.0, 2.0 16V, 2.1 TD, 2.2, 2.2 DCI, 2.2 DTI, 2.2 TD, 2.5 DCI, 2.5 CDTI, 2.5 TD, 2.8 D

Codes OEM :

KM-6031, KM-6203, KM-6204, KM-6205, KM-6234, KV113 B0130, KV113 B0280, KV113 B0360, MOT 1054, MOT 1135-01, MOT 1200-01, MOT 1312, MOT 1318, MOT 1337, MOT 1340, MOT 1348, MOT 1384, MOT 1386, MOT 1489, MOT 1490-01, MOT 1496, MOT 1534, MOT 1536, MOT 1537, MOT 1538, MOT 1543, MOT 1750, MOT 910, K9K

COMPATIBLE ENGINE CODES

D4F702	D4F706	D4F708	D4F712	D4F714	D4F716	D4F722	D4F728	D4F730	D4F740	D4F764	D7F700	D7F701	D7F710	D7F720	D7F722
D7F726	D7F730	D7F744	D7F746	D7F764	D7F766	E7F700	E7F704	E7F706	E7F750	E7J601	E7J624	E7J626	E7J634	E7J635	E7J680
E7J700	E7J706	E7J710	E7J711	E7J716	E7J718	E7J719	E7J720	E7J724	E7J726	E7J728	E7J740	E7J742	E7J745	E7J754	E7J756
E7J757	E7J764	E7J770	E7J771	E7J773	E7J780	F3P670	F3P682	F3P700	F3P704	F3P706	F3P708	F3P710	F3P712	F3P714	F3P720
F3P724	F3P755	F3P758	F3P760	F3R611	F3R722	F3R723	F3R728	F3R729	F3R750	F3R751	F3R752	F3R791	F3R796	F3R797	F3R798
F5R700	F5R701	F5R740	F7P704	F7P722	F7R710	F7R714	J7R732	J7R733	J7R734	J7R735	J7R768	F8M736	F8M760	F8Q600	F8Q610
F8Q606	F8Q620	F8Q622	F8Q624	F8Q630	F8Q632	F8Q640	F8Q644	F8Q646	F8Q648	F8Q662	F8Q672	F8Q678	F8Q680	F8Q682	F8Q684
F8Q692	F8Q696	F8Q706	F8Q714	F8Q720	F8Q722	F8Q730	F8Q732	F8Q740	F8Q742	F8Q744	F8Q764	F8Q768	F8Q706	F8Q776	F8Q784
F8Q786	F8Q788	F9Q610	F9Q650	F9Q664	F9Q670	F9Q674	F9Q71	F9Q716	F9Q717	F9Q718	F9Q720	F9Q722	F9Q730	F9Q731	F9Q732
F9Q733	F9Q734	F9Q736	F9Q738	F9Q740	F9Q744	F9Q748	F9Q750	F9Q752	F9Q754	F9Q758	F9Q759	F9Q760	F9Q768	F9Q762	F9Q770
F9Q772	F9Q774	F9Q780	F9Q782	F9Q784	F9Q786	F9Q788	F9Q790	F9Q796	F9Q800	F9Q803	F9Q804	F9Q808	F9Q812	F9Q816	F9Q818
F9Q820	F9Q820	G8T714	G8T716	G8T740	G8T752	G8T760	G8T790	G8T792	G8T794	G9T600	G9T605	G9T700	G9T702	G9T703	G9T706
G9T707	G9T710	G9T712	G9T720	G9T722	G9T742	G9T743	G9T750	G9U720	G9U724	G9U726	G9U730	G9U750	G9U754	J7T600	J7T760
J7T761	J7T762	J7T766	J7T772	J7T780	J7T782	J8S620	J8S621	J8S622	J8S758	J8S760	J8S776	J8S778	K4J700	K4J710	K4J711
K4J712	K4J713	K4J714	K4J715	K4J730	K4J732	K4J740	K4J750	K4J770	K4J780	K4M700	K4M701	K4M704	K4M706	K4M707	K4M708
K4M709	K4M710	K4M711	K4M712	K4M714	K4M716	K4M718	K4M720	K4M724	K4M730	K4M732	K4M734	K4M736	K4M740	K4M742	K4M743
K4M744	K4M745	K4M746	K4M748	K4M750	K4M752	K4M753	K4M754	K4M760	K4M761	K4M762	K4M764	K4M765	K4M766	K4M768	K4M776
K4M782	K4M788	K4M790	K4M791	K4M794	K4M800	K4M801	K4M802	K4M804	K4M812	K4M813	K4M830	K9K700	K9K702	K9K704	K9K706
K9K710	K9K712	K9K714	K9K716	K9K718	K9K722	K9K724	K9K728	K9K729	K9K732	K9K734	K9K740	K9K750	K9K752	K9K760	K9K762
K9K764	K9K766	K9K768	K9K802	K9K804	K9K806	N7Q704	N7Q710	N7Q711	N7U700	N7U701	S8U720	S8U722	S8U730	S8U731	S8U742
S8U748	S8U750	S8U752	S8U770	S8U772	S8U780	S8U782	S9U700	S9U702	S9U704	S9U714	S9U740	S9U700	S9U702	S9U704	S9U714
S9U740	S9W700	S9W702	S9W206	S9W208	S9W212	E5F	E6J	K7M	F4P	F4R	F1N	F2N	F3N	F2R	F3P
F4P	F3R	J5T	J6R	J7R											



OM 6110

COMPLETE RENAULT TIMING TOOL SET GENERATION 2©

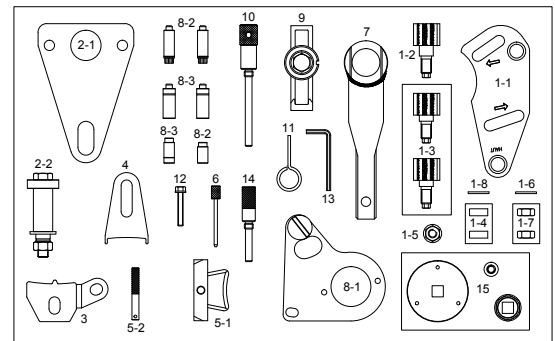

Applications:

Renault: Clio II, Espace 4 et 5, Fluence, Koleos, Laguna, Laguna 2, Latitude, Master, Megane, Megane 2, Scenic, Scenic RX4, Scenic 2, Grand Scenic 2, Trafic 2, Vel Satis
 Mercedes: Class C, 622.951, Vito
 Mitsubishi: Carisma
 Nissan: Navara NP300, Primastar X83, Qashqai 1 et 2, X-Trail
 Opel: Arena, Vivaro-B

Engines: 1.4, 1.6, 1.8 16v, 2.0 16v, 1.6, 2.0, 2.3, 2.5, 3.5, 1.9DTI/TD, 2.3DCI/CDTI

Motorization	COMPATIBLE ENGINE CODES
1.4L	H4Jt700
1.6L	M5M400 , M5M , M5M450 626.951 , LWU/R9M , LWX/R9M , LWY/R9M , LWZ/R9M , R9M , R9M 402 , 626.951 , LWU/R9M , LWX/R9M , LWY/R9M , LWZ/R9M , R9M , R9M 402 , R9M 404 , R9M 408 , R9M 409 , R9M 410 , R9M 413 , R9M 450 , R9M 452R9M 404 , R9M 408 , R9M 409 , R9M 410 R9M 413 , R9M 450 , R9M 452
1.8L 16V	F4P720 , F4P722 , F4P760 , F4P770 , F4P771 , F4P772 , F4P773 , F4P774 , F4P775
2.0L 16V	F4R700 , F4R701 , F4R712 , F4R713 , F4R714 , F4R715 , F4R720 , F4R722 , F4R730 , F4R732 , F4R740 , F4R741 , F4R744 , F4R746 F4R762 , F4R7631764 , F4R765 , F4R766 , F4R767 , F4R770 , F4R771 , F4R774 , F4R776 , F4R780 , F4R784 , F4R786 , F4R787 , F4R790 , F4R792 , F4R791 , F4R792 , F4R794 , F4R795 , F4R796 , F4R797 , F4R800 , F4R802 , F4R810 , F4R811 , F4R820 , F4R830 F4R832 , F4R867 , F4R870 , F4R874 , F4R886 , F4R887 , F4R896 , F4R897 M9R , M9R610 , M9R613 , M9R615 , M9R630 , M9R692 , M9R700 , M9R721 , M9R722 , M9R724 , M9R740 , M9R742 , M9R744 , M9R746 M9R748 , M9R754 , M9R756 , M9R760 , M9R761 , M9R762 , M9R763 , M9R780 , M9R782 , M9R784 , M9R786 , M9R788 , M9R800 M9R802 , M9R803 , M9R804 , M9R805 , M9R806 , M9R808 , M9R809 , M9R811 , M9R812 , M9R814 , M9R815 , M9R816 , M9R817 , M9R820 , M9R824 , M9R828 , M9R830 , M9R832 , M9R833 , M9R834 , M9R835 , M9R836 , M9R838 , M9R839 , M9R844 , M9R845 , M9R846 , M9R849 , M9R854 , M9R855 , M9R856 , M9R857 , M9R858 , M9R859 , M9R865 , M9R866 M4R700 , M4R701 , M4R714 , M4R750 , M4R751 , M4R752 , M4R753 , M4R737 , M4R704 , M4R726 , M4R730 , M4R735 , M4R746 M4R , M4R711 , M4R713 , M9R740 , M9R760 , M9R761 , M9R812.M9R814 , M9R815 , M9R830 , M9R832 , M9R833 , M9R834 , M9R835 , M9R836 , M9R838 , M9R855 , M9R856 , M9R865 , M9R866 , M9R742 , M9R800 , M9R805 , M9R , 700 , M9R721 , M9R722 , M9R724 M9R613 , M9R615 , M9R610 , M9R630 , M9R780 , M9R , 782 , M9R750 , M9R762 , M9R763 , M9R858 , M9R859 , M9R8 , M9R744 , M9R746 , M9R748 , M9R754 , M9R802 , M9R803 , M9R806 , M9R808 , M9R809 , M9R820 , M9R828 , M9R845 , M9R849 , M9R854 M9R857 , M9R816 , M9R756 , M9R804 , M9R811 , M9R817 , M9R824 , M9R839 , M9R844 , M9R846 , M9R692 , M9R784 , M9R786 , M9R788 , M9R
2.3L	LOB/M9T , LOC/M9T , L2U/M9T , LOD/M9T , LP6/M9T , LW7/M9T , LWJ/M9T , LWK/M9T , LWL/M9T , M9T 670 , M9T 672 , M9T 676 M9T 678 , M9T 680 , M9T 686 , M9T 690 , M9T 692 , M9T 694 , M9T 696 , M9T 698 , M9T 700 , M9T 702 , M9T 706 , M9T 708 M9T 870 , M9T M9T670 , M9T672 , M9T676 , M9T678 , M9T680 , M9T686 , M9T690 , M9T692 , M9T694 , M9T696 , M9T698 , M9T700 , M9T702 , M9T870 , M9T880 , M9T890 , M9T896 , M9T898 , M9TC6 , YS23DDT , YS23DDTI , M9T706 , M9T708
2.5L	2TR700 , 2TR700 , 2TR702 , 2TR703 , 2TR704 , 2TR705 , 2ZV604 , V4U604 , VQ25
3.5L	V4Y711 , V4Y715 , V4Y701 , V4Y713



OM 6200

MASTER TIMING TOOL SET PSA GENERATION 1



Models:

Fiat/Lancia: Ulysse, Scudo, Ducato, Zeta, Phedra
 Ford: Fiesta, Fusion, Focus, Focus C-Max
 Citroën: C15, C1, C2, C3 Pluriel, C4, C4 Picasso, C5, C6, C8, DS3, DS4, DS5, Xantia, Xsara, Xsara Picasso, Evasion, Berlingo, Jumpy, Jumper, Saxo, ZX, XM, Evasion, AX
 Peugeot: 107, 1007, 206 cc, 207, 208, 306, 307 cc, 308, 406, 407, 508, 607, 806, 807, Partner, Expert, Boxer, 206, 106, 605, 205, 405

Engines:

Fiat/Lancia: 2.0, 2.2 JTD
 Ford: 1.4, 1.6 Duratorq TDCI
 PSA: 1.0, 1.1, 1.4, 1.6, 1.6 16V, 1.4, 1.6 HDI, 1.8, 1.8 16V, 2.0, 2.0 turbo, 1.9 D, 2.0 HDI, 2.2 HDI, 1.8 16V, 2.0 16V

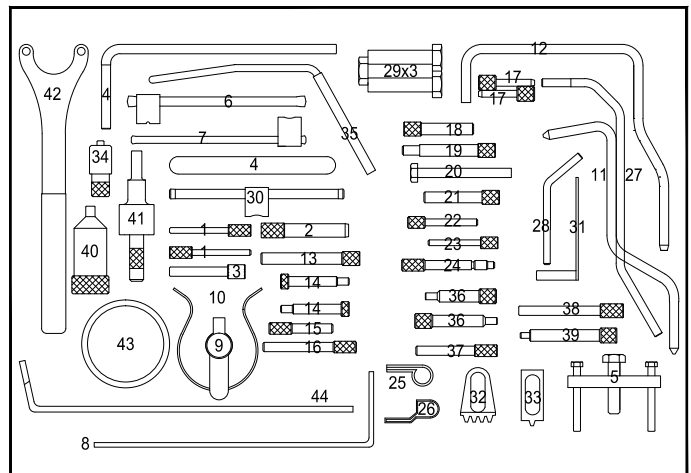

Codes OEM :

0117-AR , 0132-AB , 0132-AJ1 , 0132-AJ2 , 0132-AK , 0132-P , 0132-Q , 0132-QZ , 0132-R , 0132-X , 0134-AF , 0134-Q , 0153-A , 0153-AB , 0153-AK , 0153-G , 0153-M , 0153-N , 0153-U , 0178-B , 0178-C , 0178-D , 0178-E , 0188-AH , 0188-AK , 0188-D , 0188-E , 0188-F , 0188-H , 0188-J1 , 0188-J2 , 0188-M , 0188-P , 0188-P2 , 0188-Q2 , 0188-Y , 0189-A , 0189-B , 0189-C , 0189-J , 0189-K , 0189-L , 0189-R , 0189-S1 , 0189-S2 , 0194-A , 0194-B , 0194-C , 0606-A1.A2 , 188-Q1 , 21-163 , 21-262 , 303-734 , 4200-TH , 4507-TA , 4507-TB , 4507-TJ , 4507-TL , 4527-TS1 , 4527-TS2 , 4533-TAC1 , 4533-TAC2 , 4533-TAD , 5711-TA , 5711-TB , 6012-T , 7004-TG , 7014-TJ , 7014-TM , 7015-T , 7017-TM , 7017-TR , 7018-TY , 7019-T , 7099-TM , 9004-T , 9041-TZ , 9765-54 , 9767-27 , 9767-89 , 9767-94 , 9797-34 , MOT1436

Motorization	COMPATIBLE ENGINE CODES
Fiat/Lancia	Fiat/Lancia : DW10ATED (RHT/RHV/RHW/RHX/RHZ) , DW12TED4 (4HW)
Ford	F6JA , F6JB , F6JC , G8DA , G8DB , HHDA , HHDB , HHJA , HHJB
PSA	TU9 (CDY/CDZ) , TU1 (HDY/HDZ/HFX/HFY/HFZ) , TU3 (KDX/KDY/KDZ/KFX/KFZ) , TU5 (BDY/BFZ/NFT/NFV/NFW/NFY/NFZ) , TU5JP4 (NFU/NFX) , XU7 (LFW/LFX/LFZ) , XU7JP4 (LGY) , XU10 (RFL/RFU/RFW/RFX/RGX/RGY) , XU10JP4(RGX/RGY) , EW7J4 (RLZ) , EW10A (RFJ) , EW10J4S (RFK) , EW10D (RLZ) , EW12J4 (3FZ) , ET3JE (KFU) , TU3A/JP (KfV/KfW) , DV4TD (8HW/8HX/8HZ) , DV4TED4 (8HV/8HY) , DV6ATED4 (9HX/9HY/9HZ) , EW10-CVI (RLZ) , EW12 (3FZ) , DW8 (WJZ/WJY) , DW10 (RHY/RHV/RHZ/RHS/RHM/RHW/RHT/RHR/RHX) , DW12 (4HX/4HZ/4HW/4HY) , EW7J4 (6FZ) , EW10J4 (RFR) , EW10J4D (RLZ)

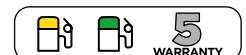

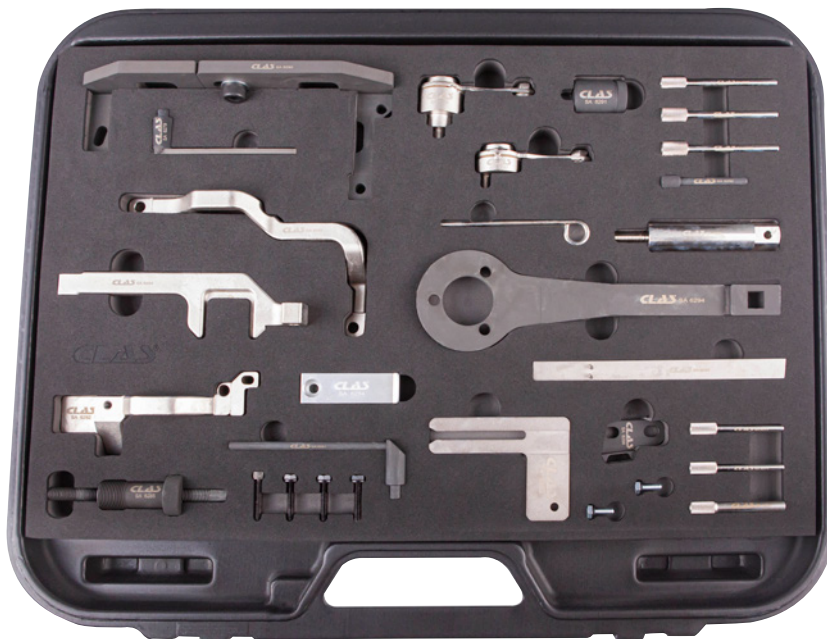
OM 6210
COMPLETE PSA TIMING TOOL SET GENERATION 2©

Models:

PSA: 1007, 108, 206, 206 CC, 207, 207cc, 208, 2008, 301, 307, 308, 308cc, 308, 3008, 407, 407 Coupé, 5008, 607, Partner III C2, C3, C3 Picasso, C3, C3111, C4, C4 Picasso, C4, C4 Picasso, Grand Picasso, C5 II, C5 III, C6, Berlingo III, DS3, DS3 Cab, C-Elysée, Xsara Picasso
 Mini: One (R56), Mini Cooper (R55/R56), Mini Cooper S (R55/R56), Cooper/S, Mini One, Clubman
 Jaguar: S-Type, XF, XJ, XJ6
 Land Rover: Range Rover Sport, Discovery 3 & 4

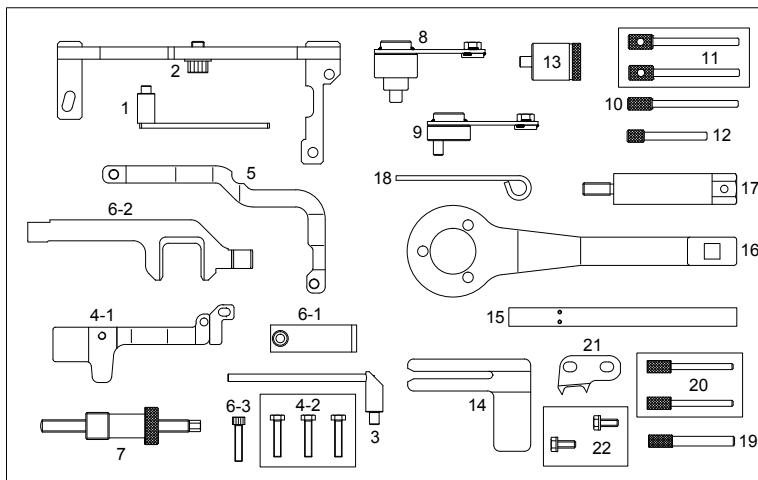
Engines: 1.0, 1.2i, 1.4, 1.4 VTI, 1.6, 1.6 VTI, 1.6 THP, 1.6 diesel, 1.8, 2.0, 2.5, 3.0 L, 2.7 D/TDV6/HDi/TDVi



COMPATIBLE ENGINE CODES

ZMZ	ZM01	EBO	HMZ	HMT	HMY	HM01	HM02
HNY	HNZ	HN01	HN02	EB2	EB2F	EB2DT	EB2DTS
N12 B14AB	N12 B16A	N51	N52	N52K	N53	N54	N40
N45	N45T B16	N42	N46 B18	B18A	B20	B20/A	B20B
8FR (EP3)	5FS (EP6)/EP3 (8FS)	EP6 (5FW)	EP6DT (5FX)	8FS (EP3)	EP6DTS (5FY)	DV6TED4 (9HX, 9HY, 9HZ)	W16D16 (9HZ)
W16D16UO	276DT	DT17BTED4 (JHZ)	D20CTED4 (X8Z)	3.0 D/HDi /SDV6/TDV6	306DT	AJ-V6D	EP3(8FS)
EP6(5FW)	EP6DT(5FX)	EP6DTS(5FY)	116i E811 E87	316i E46 E90	316Ci E46	128i E82	130i E811 E87
135iS E82	323i E90 E911 E92 E93	325i/xi E90 E911 E92 E93	328i/xi E90 E911 E92 E93	330i/xi E90 E911 E92 E93	335i/xi E90 E911 E92 E93	523i/Li E60 E61	525i/Li/xi E60 E61
528i/xi E60 E61	530i/Li/xi E60 E61	535i/xi E601 E61	630i E63 E64	730i/Li E65 E66	X3 2.5/3.0 E83	X5 3.0 E70	Z4 2.5/3.0 E85 E86

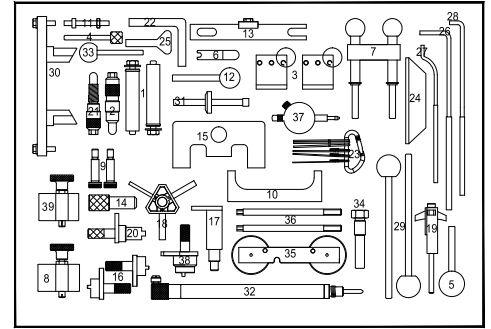
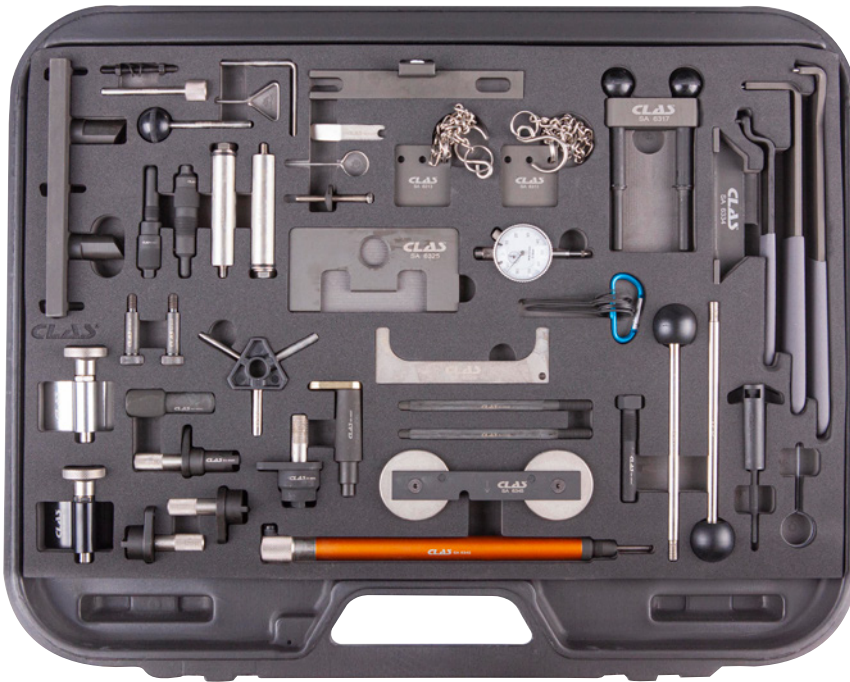

OM 6300

MASTER TIMING TOOL SET VAG



Models:

Audi: 80, A1, A2, A3, A3 cabrio, S3, A4, A5, A6, TT, Q5
 Seat: Arosa, Ibiza, Cordoba, Leon, Toledo, Alhambra, Altea, Inca (99-04)
 Skoda: Fabia, Octavia, Superb
 VW: Lupo, Polo, Fox, Golf, Bora, Jetta, Golf Plus, Golf estate, Passat,
 Beetle, Touran, Sharan, Caddy, Caddy Maxi,
 Transporter, Golf VI cabrio, Tiguan
 Ford: Galaxy

Engines:

Petrol: 1,2 TSI, 1.4, 1.4 TSI, 1.6 16V, 1.2 9V-12V 3cylindres, 1.4, 1.6 FSI (chain), 1.8, 1.8 16V, 1.8T, 2.0 16V, 2.0 FSI/TFSI (belt)
 Diesel : 1.2 TDI PD, 1.4 TDI PD, 1.9 TDI 75-90-110 PF, 1.9 SDI 75-90-110 PF, 1.9 TDI 105-130-150 PF, 2.0 TDI PD, 2.0 TDI DPF 140-170 PF, 2.5 TDI V6

Codes OEM :

2064, 2065-A, 21-105, 23-058, 23-059, 23-059, 2587, 303-1054, 310-084, 310-085, 3242, 3359, 3366, 3369, 3387, 3411, 3418, 3458, MATRA V.159, MP1-1312, MP1-301, T00115, T10008, T10016, T10020, T10050, T10050, T10060, T10060A, T10074, T10074, T10092, T10098, T10100, T10115, T10120, T10121, T10123, T10170, T10171, T10252, T10264, T10340, T10341, T10414, T20018, T20038, T20038, T20044, T20102, T30052, T30092, T30094, T40011, T40026, T40069, T40098, U20003, U30009A, U40021, VAS6079

COMPATIBLE ENGINE CODES

ARC	ATN	AUS	AVY	AZD	AFH	BCA	AJV	AKQ	AUA
AUB	AXP	AFH	AFN	AFK	AHW	AHU	APE	AQQ	AUS
AXP	AZD	BBY	BBZ	BCB	ANY	AYZ	AMF	ATL	BAY
BHC	BMS	BNM	BNV	BWB	AJM	AMG	ANU	ARL	ASZ
ATD	ATJ	AUY	AVB	AVF	AVQ	AWX	AXB	AXC	AXR
BEW	BJB	BKC	BKE	BLS	BLT	BMT	BPX	BRB	BRM
BRR	BRS	BRU	BSU	BSW	BTB	BUK	BVK	BXE	BXF
AZV	BDJ	BDK	BGW	BHW	BKD	BKP	BLB	BMA	BMM
BMN	BMP	BMR	BNA	BPW	BRC	BRE	BRF	BRT	BUZ
BE	BVF	BVG	BVH	BWK	BTS	BMV	BLF	BWV	AZV
BKD	AWY	AZQ (55-64PF)	AXU	BAG	BKG	BLF	BLN	BLP	BFV
BKF	BNU	BVP	BVR	IZ	CBZA	CBZC	CBZB	CAXA	CAGA
CAGB	CAGC	CAHA	CAYA	CAYB	CAYC	CBAA	CBAB	CBAC	CBBA
CBBB	CBDA	CBDB	CBDC	CBEA	CEGA	CKUB	AZV	BDJ	BHP
BKD	BLB	BMA	BMM	BMN	BMP	BMR	BNA	BPW	BRC
BRE	BRF	BRT	BSS	BUY	BUZ	BVA	BVE	BVF	BVG
BVH	BWV	ACV	ACV	AFB	AGX	AHD	AHY	AHY	AJT
AJT	AKE	ANJ	APA	AUF	AXG	AXG	AXL	AXL	AYC
AYC	AYM	AYY	BAU	BBE	BBF	BCZ	BDG	BDH	BFC
BJJ	BJK	BJL	BJM						

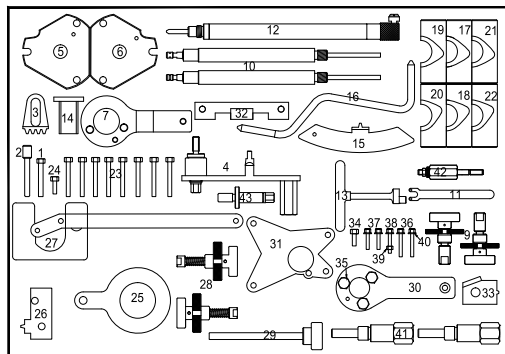
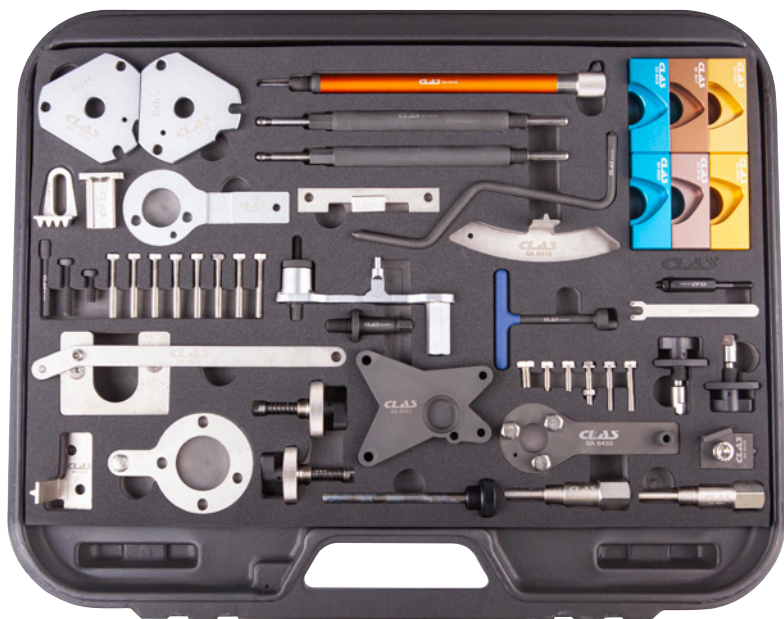

OM 6400
MASTER TIMING TOOL SET FIAT/ALFA/LANCIA/OPEL/SUZUKI/FORD

Models:

Alfa: 145, 146, 147, 155, 156, Spider, GTV, TS, GT, 159, 166, Crosswagon Q4
 Fiat: Punto, Grande Punto, Brava/Bravo, Marea, Weekend, Stilo, Doblo/
 Cargo, Idea, Panda, Multipla, Palio, Stilo, 500
 Lancia: Lybra, Ypsilon, Thesys, Musa,
 Opel: Corsa, Agila, Meriva, Combo, Vectra, Zafira, Astra, Insigna, Signum
 1.9 CDTi
 Suzuki: Ignis, Swift, Wagon R+
 Ford: Ka

Engines: 1.2 8V, 1.2 16V, 1.4 16V, 1.6 16V, 1.6 MultiJet, 1.9 JTD, 1.9 JTD 16V, 1.9
 MultiJet, 2.4 JTD, 1.9 CDTi, 2.0 MultiJet, 2.4 JTD 20V, 1.3 JTD MultiJet, 1.3
 CDTi, 1.3 TDCI, 1.9 CDTi

Codes OEM :

1860703000, 1825041000, 1825042000, 1860161000, 1860771000,
 1860845000, 1860847000, 1860863000, 1860874000, 1860876000,
 1860898000, 1860905000, 1860933000, 1860965000, 1860985000,
 1860987000, 1860992000, 1870900300, 1870900400, 1871000900,
 1895443000, 2000004200, 2000004300, 2000004400, 2190754200,
 2190754400, 2190754500, EN-46788

COMPATIBLE ENGINE CODES

176B9.000	182B2.000	188A5.000	843A1.000	323.02	371.01	182B4.000	182B9.000	186A6.000	188A2.000
188A7.000	188B2.000	192A1.000	192A3.000	937A2.000	939A1.000	192A5.000	192B1.000	198A5.000	937A5.000
939A2.000	325.01	342.02	362.02	185A6.000	841C.000	841G.000	939A3.000	940A3.000	940A4.000
940A5.000	Z19DT	Z19DTH	Z19DTR	Z19DTJ	Z19DTL	169A1.000	955A4.000	350A3.000	192B4.000
198A2.000	350A2.000	955A3.000	192A8.000	198A6.000	198A3.000	199B1.000	199B2.000	199A2.000	199A3.000
199A9.000	188A3.000	188A8.000	188A9.000	192A9.000	186A8.000	186A9.000	199A5.000	223A7.000	223A9.000
841H.000	841P.000	185A2.000	Z13DT	Z13DTJ	Z13DTH	182A4.000	182A6.000	182B6.000	178B3.000
186A3.000	186A4.000	350A1.000	169A4.000	188A4.000	199A4.000	199A7.000			

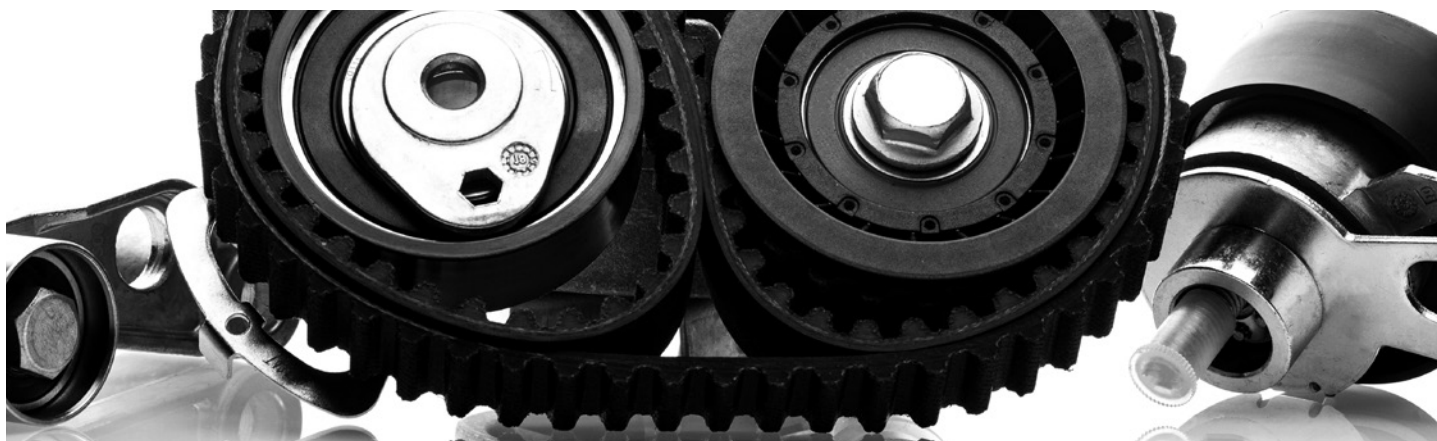

OM 6500

MASTER TIMING TOOL SET OPEL/CHEVROLET/SAAB/FIAT/LANCIA/SUZUKI/FORD

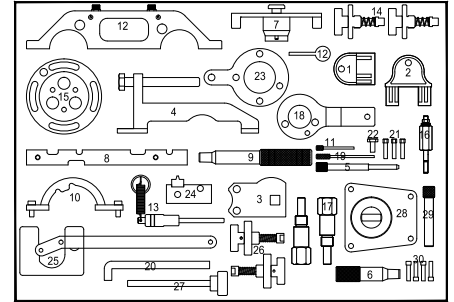
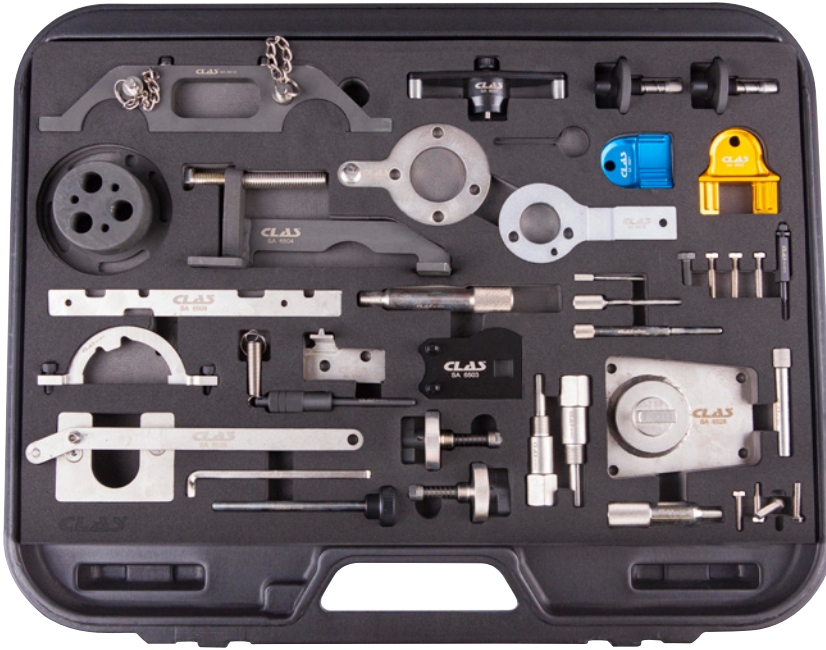

Models:

Opel: Corsa B,C, Combo, Tigra, Agila,Tigra B, Meriva, Astra F,G , H, Astravan ,Speedster/VX220, Zafira A , B, Vectra B , C, Signum, Omega B, Sintra, Frontera A , B , Astravan, Kadett, Ascona, Omega, Monterey, Antara ,Croma ,Speedster/VX220
 Chevrolet/Daewoo: Epica, Captiva, Nubira, Lacetti, Evanda
 Saab: 9-3, 9-5 (98-04)
 Alfa: 145, 146, 147, 156, 159, 166, GT, Crosswagon Q4
 Fiat: Punto, Grande Punto, Bravo/Brava, Marea, Weekend, Stilo, Doblò/ Cargo, Multipla, Idea, Panda
 Lancia: Ypsilon, Musa, Lybra, Thesys
 Suzuki: Ignis, Swift, Wagon R+
 Ford: Ka

Engines: 1.0 12V, 1.0 16V, 1.2 16V, 1.4 ,1.6, 1.2-1.4 16V (Chain), 2.0, 2.0 Turbo, 2.2 DI, 2.0-2.2 16V, 1.6 16V, 1.8 16V, 2.0 16V, 2.2 16V, 1.3 JTD MultiJet, 1.3 CDTI, 1.3 TDCI, 1.6 MultiJet, 1.9 JTD, 1.9 MultiJet, 2.4 JTD, 1.9 CDTI, 2.0 MultiJet, 1.5 D, 1.5 TD, 1.7 D, 1.7 TD, 1.6-1.7 D, 3.0 TD, 3.1 TD, 2.0-2.2-2.4 TD, 2.0-2.2 DI, 2.0 TDCI, 2.0 D VCDI, 2.2 16V (double camshaft)

Codes OEM :

1860703000, 1860905000, 1860985000, 1870900300, 1871000900, 21-162B, 303-1468, 303-376, 303-376B, EN-46781, EN-46785, EN-46785, EN-46788, EN-46789, EN-48245, EN-48246, KM-6130, KM-6148, KM-6349, KM-6349, KM-852, KM-853, KM-911, KM-927, KM-929, KM-932, KM-933, KM-951, KM-952, KM-954, KM-955, KM-J-43651

COMPATIBLE ENGINE CODES

X14XE	Z14XE	X16SEJ	X16XE	X16XEL	Y16XE	Z16XE	Z16YNG	C18XEL	X18XE
X18XE1	Z18XE	Z18XEL	C20SEL	C20XE	X20XEV	Z20LEH	Z20LEL	Z20LER	Z20LET
X22SE	X22XE	Y22SE	Y22XE	Z22XE	D223L	X10XE	Z10XE	Z10XEP	X12XE
Z12XE	Z14XEP	X20DTL	X20DTH	X22DTH	Y20DTL	Y20DTH	Y22DTH	Y22DTR	169A1.000
955A4.000	350A3.000	192B4.000	198A2.000	350A2.000	955A3.000	192A8.000	198A6.000	198A3.000	199B1.000
199B2.000	199A2.000	199A3.000	199A9.000	940A3.000	188A3.000	939A2.000	188B2.000	188A8.000	188A9.000
323.02	371.01	937A2.000	182B4.000	182B9.000	188A2.000	188A7.000	192A9.000	186A6.000	186A8.000
192A1.000	192A3.000	192B1.000	192A5.000	186A9.000	939A1.000	199A5.000	223A7.000	223A9.000	342.02
362.02	841G.000	841H.000	841P.000	939A3.000	185A2.000	185A6.000	Z13DT	Z13DTJ	Z13DTH
Z19DT	Z19DTH	Z19DTJ	Z19DTL	X10XE	Z10XE	Z10XEP	Z12XE	Z14XEP	X16SZR
Z16SE	4ECIT	4ECI	4EE1T	4EE1	X17DT	Y17DT	Y17DTi	Y17DTL	16DA
17D	17DR/X	7DTL	X17DTL	4JX1/4	JG2T	4FC1	4FCIT	4FD1	X20DTL
Y20DTL	D223L	Z20DMH	Z20DM	RA420	Z20S1	194A1.000	Z22SE	Z22YH	

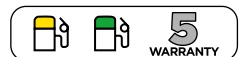

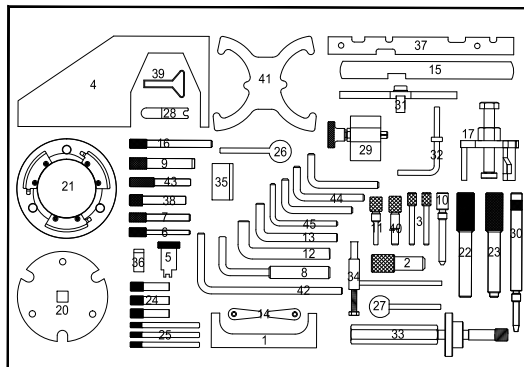
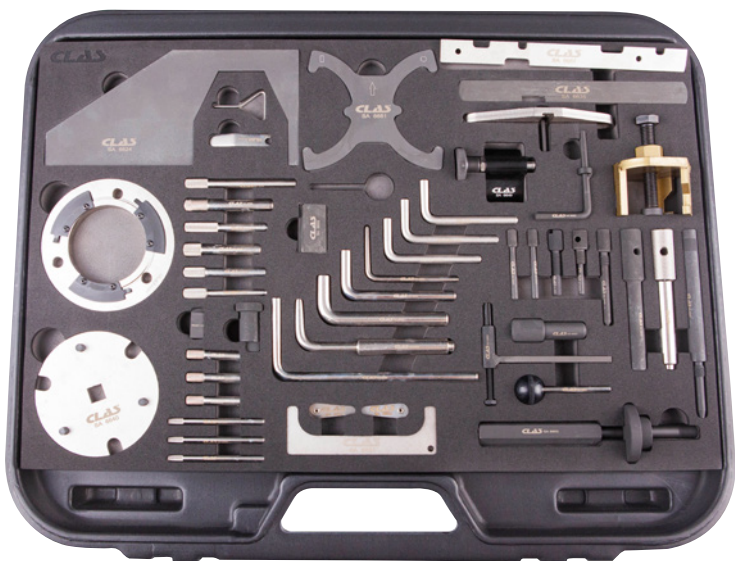
OM 6600
MASTER TIMING TOOL SET FORD/MAZDA/VOLVO

Models:

Ford: Fiesta, Fusion, Courier, Escort, Focus, Focus C Max, Puma, Mondeo, Sierra, Transit, Connect, Cougar, Courier, Courier Kombi, Galaxy ,C-Max ,Orion, Tourneo Connect, Transit, Transit Connect
VW: Sharan

Seat: Alhambra

Mazda: 121

Volvo: S40, V50 petrol, 1.8 D, 1.8 TD, 240 D, 740 D, 760 D, 940 D, 960 D Turbo

Engines: 1.2, 1.4, 1.6, 1.6 16V, 1.7 16V belt, 1.8-2.0 16V (belt et chain), 1.4, 1.6 16V Focus et Mazda 121, 1.6 Duratorq TDCI, 1.8 D, 1.8 TD (88-00), 1.8 DI (belt) (98-04), 1.8 TDCI (belt) (01-04), 1.6 D, 1.9 TDI, 2.5 D/TCI (belt), 1.9 TDI, 2.5 D/TCI (belt), 1.25, 1.6 TI-VCT, 1.6 SCTI, 1.4 D TDCI, 1.6 D TDCI, 1.8 D, 1.8 D TCI, 1.8 D TDDI, 1.8 D TDCI, 1.8 D Turbo, 1.8 D Turbo, 1.9 D TDI PD, 1.9 D TDI PD, 2.0 D TDCI, 2.2 TDCI, 2.5 D, 2.5 D Turbo, 2.0, 2.2, 2.4 Duratorq TDCI 16V, 1.4 D TDCI, 1.6 D 8V, 1.6 D 16V

Codes OEM :

0132-AB, 0153-M, 0178-B, 0178-C, 0178-D, 0194-B, 0194-C, 2064, 21-104, 21-105, 21-123, 21-151, 21-162B, 21-163, 21-168, 21-210, 21-229, 21-234, 21-238, 21-251, 21-260, 21-262, 21-263, 23-019, 23-020, 23-047, 23-058, 23-059, 303-0985, 303-1054, 303-1059, 303-1060, 303-1061, 303-1097, 303-1151, 303-193, 303-367, 303-376, 303-376B, 303-393, 303-393-01, 303-393-02, 303-620, 303-651, 303-652, 303-675, 303-679A, 303-698, 303-732, 303-734, 303-735, 303-748, 310-055, 310-084, 310-085, 323-029, 49 JE 02 020, 49 JE 02 021, 5711-TB, U20003

COMPATIBLE ENGINE CODES

FUJA	FUJB	FXJA	FXJB	FXJB	FYJA	FYJB	F8JA	F8JB	M7JA	M7JB
DHA	DHB	DHC	DHD	DHE	DHF	DHG	FHA	FHE	LIT	LIV
LIE	LIG	LIH	LIK	RDA	RDB	RKC	RQB	RQC	FXDA	FXDC
FXDB	FXDD	FYDA	FYDC	FYDB	FYDD	FYDH	HWDA1Z	AHU	AVG	AFN
D24	D24T	D24TIC	RFN	RTJ	RTK	RVA	RFK	RKD	B4164S3	DV4TD (8HV/8HX/8HZ)
DV4TED4 (8HV/8HY)	DV6ATED4 (9HX/9HY/9HZ)	F6JB	F6JC	G8DA	G8DB	KKDA	SNJA	SNJB	STJA	STJB
ASDA	ASDB	FXJC	SPJA	SPJC	FYJC	HWDA	HWDB	SHDA	SHDB	SHDC
JQDA	LQDB	JTDA	JTDB	HXDA	HXJA	HXJB	IQDA	IQDB	PNBA	PNDA
RHBA	SIDA	F6JD	TZJA	TZJB	HHDA	HHDB	HHJA	HHJC	HHJD	HHJE
HHJF	RTA	RTB	RTC	RTD	RTG	RTE	RTF	RTH	RTJ	RTK
RFN	BHPA	HCPA	HCPB	KKDA	P7PA	P9PA	P9PB	R2PA	R3PA	RWPA
RWPC	F9DA/B	FFBA	FFWA	KHBA	QYBA	QYWA	KKDB	C9DC	RVA	1Z
AFN	AHU	ANU	AUY	G6DA	G6DB	G6DC	G6DD	G6DE	G6DF	G6DG
UFDB	TXDB	TYDA	UKDB	QXBA	AZBA	KLBA	QXBB	LPBA	AZBC	TYBA
UKBA	UFBA	TXBA	IXDA	QXWA	QXWB	AZWA	KLWA	AZWC	TYWA	UKWA
TXWA	UFWA	UFDA	TXDA	UKDA	Q4BA	KNBA	4BA	4BB	4BC	4CC
4FA	4CA	4CB	4DA	4EA	4FA	4FB	4FC	4FD	4GA	4HB
4HC	4EB	4EC	4ED	4GA	4GB	4GC	4GD	4GE	4GF	4HA
4HD	FMBA	FMBB	D5BA	ABFA	D3FA	D6BA	HJBA	HJBB	F3FA	D2FA
D4FA	F4FA	FIFA	DOFA	QJBA	QJBB	QJBC	QJBD	FXFA	H9FA	H9FB
N7BA	N7BB	MZ-CD 1.6	Y6	F6JA						

AC 1020

COOLING SYSTEM FILLING/DRAINING DEVICE

This mobile device allows to drain, check the tightness, clean, create a vacuum to purge the cooling circuit and fill it, thanks to its venturi system coupled to a pressure gauge. Ensures an ecological intervention since almost all the used coolant in the cooling system is recovered; allowing the user to disassemble any engine component without the need for coolant flow.



90° quick connector



Fast intervention
No pollution of the ground

Addition of a filter to prevent clogging of the waste liquid tank



Specifications:

- 2 independent 15-liter tanks for storing polluted and new liquid
- 2 manometers for tank control
- connection to the expansion tank via a conical adapter
- 3 dip tubes of different lengths
- 4 swivel wheels
- dimension: L.430xI.610xH.1350mm
- weight: 43kg

Functions:

- used liquid extraction
- depression
- new liquid filling
- emptying used liquid tank
- emptying new liquid tank

Options:

- AC1021: Cooling system filling/drainage hose adapters
- AC1022: Gravity cooling system drain adapter



Enlarged tank base for increased machine performance

NEW



OM 0369
FLYWHEEL LOCKING TOOL BMW 2.0-3.0D

Models: Series 1 E81, E82, E87, E88, Series 3 E46, E90, E91, E92, E93, Series 5 E60, E61, Series 7 E65, E66, X3 E83, X5 E53, E70, X6 E71, E72

Engines: 2.0D 4 cylinders, 3.0D 6 cylinders

Codes OEM :

11 5 180 , 11 6 180

COMPATIBLE ENGINE CODES

20 4D4	30 6D2	30 6D3
30 6D4	30 6D5	30 6D6

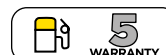
OM 0784
TORQUE WRENCH WITH INTERCHANGEABLE HEADS 3/8"
D. 30-110Nm 331mm

Delivered with
calibration certificate



Heads: 10-11-12-13-14-15-16-17-18-19
Conform DIN ISO 6789 2017-1

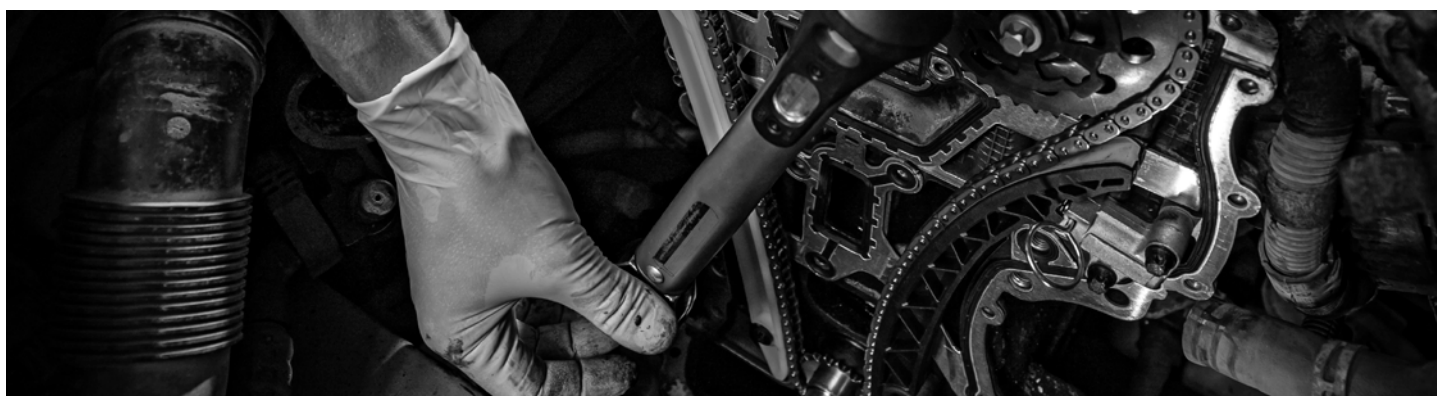

OM 3621

1/2" D. TORX WRENCH 50 SQUARE FOR RENAULT

For tensioner pulley



Models: Laguna, Megane II, Scenic II, Grand Scenic II.
Engines: 1.4 and 1.6

Codes OEM :
MOT 1368

COMPATIBLE ENGINE CODES

K4M

K4J



TN

OM 3627

PULLEY LOCKING TOOL RENAULT

Lets you lock the camshaft when replacing the timing belt.



Models: Clio II, Megane, Megane II, Scenic, Scenic RX4, Scenic II, Grand Scenic II, Laguna, Laguna II, Espace IV, Grand Espace IV, Trafic II

Engines: 1.8 16v, 2.0 16v

Codes OEM :
MOT 1801

COMPATIBLE ENGINE CODES

F4P

F4R



TN

OM 3653

UNIVERSAL PULLEY LOCK WRENCH



TN

OM 3654

UNIVERSAL BELT WRENCH

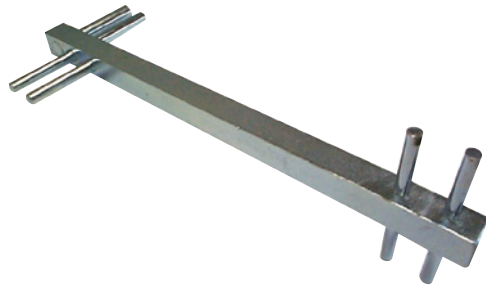

TN

OM 3657

TIMING TOOLS 1.6-1.8 BMW PETROL

Models:

- 316, 318, 518, Z3 / serie 3 (E30) II, serie 3 (E36) III, serie 3 (E46) IV, serie 5 (E34) III

Codes OEM :

11-2-300, 11-3-190

COMPATIBLE ENGINE CODES

E30

E34

E36

E46

M40

M43

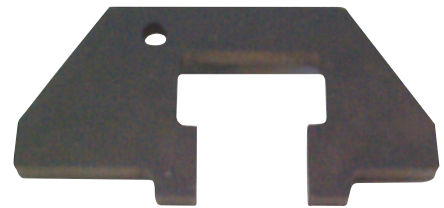

TN

OM 3666

TIMING PINS RENAULT/OPEL/NISSAN

Camshaft/crankshaft timing pins

Engines: 1.6D, 1.9D, 1.9TD, 1.9TDI, 1.9DCI, 1.5DCI, 1.2, 1.4, 1.6, 1.8, 1.4 16V, 1.6 16V, 1.8 16V

Codes OEM :

KM-6031, KV113 B0130, KV113 B0280, MOT 1054, MOT 1489,



TN

OM 3673
TIMING TOOLS BMW/ROVER/OPEL PETROL-DIESEL

Complete kit to let you correctly position the camshaft and engine shaft while changing the timing belt

Models:

BMW: 318 TDS/Compact (E36), 318iS (E30), 318iS Coupé Compact (E36), 318Ti Compact (E36), 320i, 323i, 325i, 328i (E36), 520i (E34/E39), 523i (E39), 525i (E34), 528i (E39), 728i (E38), Z3 1.9/2.8i (89-98)

BMW petrol engines: 316i/Compact (E30 1.6/E36/E46), 318i (E30 E36 E46) 518i (E34 VANOS), Z3 1.8/1.9i (88-04)

BMW diesel engines: 325 TD/TDS (E36), 525 TD/TDS (E34/E39), 725 TDS (E38) (91-03)

Rover: 75, Range Rover

Opel/ Vauxhall: Omega

Engines: 2.5 TD/TDS

Codes OEM :

11-2-300 , 11-3-190 , 11-3-240 , 11-3-292 , 11-3-320 , 11-3-390 , 11-4-220 , 11-5-490

COMPATIBLE ENGINE CODES

M40 (courroie)	M43 (chaîne)	M42
M44	M50	M52 (chaîne)

OM 3674
TIMING TOOLS RENAULT/OPEL/NISSAN/SUZUKI DCI
Models:

Renault: Clio, Kangoo, Laguna, Espace, Master, Mégane/Scénic, Trafic

Nissan: Kubistar, Interstar, Qashqai

Opel: Vivaro, Movano

Suzuki: Grand Vitara

Engines: 1.5 DCI, 1.9 TD, 1.9 DCI, 2.2 DCI, 2.5 DCI

Codes OEM :

KM-6031 , KM-6203 , KM-6204 , KM-6205 , KM-6234 , KV113 B0130 , KV113 B0280 , KV113 B0360 , MOT 1054 , MOT 1200-01 , MOT 1489 , MOT 1534 , MOT 1536 , MOT 1537 , MOT 1543 , MOT 910

COMPATIBLE ENGINE CODES

K9K700	K9K702	K9K704	K9K706	K9K710	K9K712	K9K714	K9K716	K9K718	K9K722
K9K724	K9K728	K9K729	K9K732	K9K734	K9K750	K9K752	K9K760	K9K762	K9K764
K9K766	K9K768	K9K790	K9K792	K9K830	K9K832	K9K834	K9K836	F9Q650	F9Q660
F9Q664	F9Q670	F9Q674	F9Q680	F9Q690	F9Q740	F9Q746	G9T	G9U	

OM 3677
DAMPER PULLEY LOCKING TOOL BMW-PSA PETROL
Models:

BMW: 1.6-1.8-2.0-2.5-3.0

Mini Cooper/Cooper S: 1.4-1.6

Citroën: C4/C4 Picasso

Peugeot: 207/207 CC, 308

COMPATIBLE ENGINE CODES

B12 B16A	N12 B14AB	N40	N42
N45/N45T	N46/N46T	N51	N52/N52K
N53	N54	R55/R56	



OM 3678

UNIVERSAL CAMSHAFT BELT PULLEY LOCKING LEVER TOOL

Contains the special phase shifting tool for Renault petrol engines.



Codes OEM :
T10172 , T10554

Codes moteurs :
10172A , T10544



OM 3686

TIMING TOOL RENAULT/NISSAN/OPEL 1.6-2.0-2.3 DCI-CDTI

Models:

Renault: Megane, Scenic, Laguna, Latitude, Fluence, Espace, Trafic, Koleos, Vel Satis
Nissan: Primastar, Qashqai, X-trail, NV 400
Opel: Vivaro, Movano
Mercedes: C180

Engines: 1.6, 2.0, 2.3 DCI et CDTI

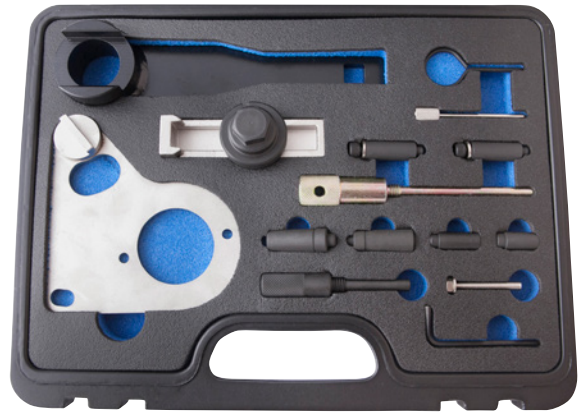

COMPATIBLE ENGINE CODES

626.951	LQI/ R9M452	LWU/ R9M450	LWX/ R9M408	LWX/ R9M413	LWY/ R9M452	LWZ/ R9M408	R9M	M9R630	M9R700
M9R780	M9R782	M9R784	M9R786	M9R788	M9R	M9R610	M9R615	M9R630	M9R700
M9R720	M9R721	M9R722	M9R724	M9R740	M9R742	M9R744	M9R746	M9R748	M9R750
M9R754	M9R760	M9R761	M9R762	M9R763	M9R780	M9R782	M9R784	M9R786	M9R788
M9R800	M9R802	M9R805	M9R808	M9R812	M9R814	M9R815	M9R816	M9R820	M9R830
M9R832	M9R833	M9R834	M9R835	M9R836	M9R838	M9R845	M9R849	M9R855	M9R856
M9R858	M9R859	LOD/ M9T702	LOD/ M9T708	LP6/ M9T706	LW7/ M9T706	LWK/ M9T708	LOB/ N9T870	L2U/ M9T680	L2U/ M9T880
L2U/ M9T896	L2U/ M9T898	LWJ/ M9T880	LWJ/ M9T896	LWJ/ M9T898	LWK/ M9T870	LWK/ M9T890	LWK/ M9T892	LWL/ M9T870	LWL/ M9T890
M9T670	M9T672	M9T676	M9T678	M9T680	M9T686	M9T690	M9T692	M9T694	M9T698
LW7/ M9T706	M9T670	M9T672	M9T676	M9T678	M9T680	M9T686	M9T690	M9T692	M9T694
M9T696	M9T698								



OM 3689

TIMING TOOLS ALFA PETROL

Models: 145, 146, 147, 155, 156, Spider, GTV TS

Engines: 1.4, 1.6, 1.6 16V, 1.6 16V with displacement pulley, 1.8, 2.0, 2.0 16V

Codes OEM :
1825042000 , 1860845000 , 1860847000



COMPATIBLE ENGINE CODES

162.01	321.02	321.03	321.04	322.01
323.01	323.10	335.03	341.03	671.06
672.04	676.01	192A4000	182B3000	



OM 3691

TN

TENSIONING BELT WRENCH JTD MULTIJET

Accessory for OM 6400/OM 6500

Models:

Alfa: 145, 146, 147, 156, 159, 166, Mito, Giulietta, Brera, Gt, Spider
 Fiat: 500L, 500X, Punto, Grande Punto, Stilo, Brava, Bravo, Cromia, Idea, Marea, Doblo, Ducato, Freemont, Multipla
 Lancia: Delta, Kappa, Lybra, Musa Thesis
 Opel: Astra H-J, Vectra C, Zafira B, Insignia, Signum, Cascada, Combo
 Saab: 9.3, 9.5
 Suzuki: SX4

Engines: 1.6 JTD, 1.6 D, 1.9 JTD-JTDM ; 1.9 D, 1.9 TD, 1.9 CDTI, 1.9 TID-TTID, 1.9 DDIS, 2.0 JTD, 2.0 D, 2.0 CDTI, 2.0 TID, 2.2 TTID, 2.4 JTD, 2.4 TD

OM 3695

TN

KEY TENSIONING BELT FORD

Accessory for OM 6600

Applications:

Duratorq 2.0L, 2.2L TDDi and TDCi

COMPATIBLE ENGINE CODES

D5BA	D6BA	HJBA	HJBC
FMBA	N7BA	QJBB	QJBA

OM 3694

TN

PSA/FORD AUXILIARY BELT TENSIONER SET
Applications:

Citroën: C1, C2, C3 III, C3 Pluriel, C4 Picasso
 Ford: B-Max, C-Max, Fiesta, Focus, Focus C-Max, Fusion, Galaxy, Grand C-Max, Mondeo, S-Max, Tourneo, Transit.
 Mazda: 2, 3
 Mini: One, Cooper, Clubman
 Peugeot: 107, 1007, 206, 206 CC, 206 SW, 307, 307 SW, 508
 Toyota: Aygo
 Volvo: C30, S40, S80, V50, V70

Engines: 1.4, 1.4 TDCI, 1.4 DiD, 1.5 TDCI, 1.6 HDI, 1.6 TDCI, 1.6 16v, 1.6 D4, 2.0 HDI, 2.2 HDI

Codes OEM :

01099 , 0188-Z , G-01099 , PZ4L0-G0109-90

COMPATIBLE ENGINE CODES

2WZTV	8HT (DV4TD)	8HX (DV4TD)	8HY (DV4TED4)	8HZ (DV4TD)	DV4	DV4TD	F6JB	F6JD
KVJA	AEDA	ENUG	UGCA	UGCB	UGCC	UGJC	UGJE	UGJG
XUCA	XUCC	XUCD	XUGA	XUJA	XUJB	XUJC	XVCA	XVCB
XVCC	XVGA	XVGB	XVGC	XVJA	XVJB	XVJC	XVJD	XVJE
XWDA	XWDB	XWDC	XWDD	XWDE	XWGA	XWGB	XWJA	XXDA
XXDB	XXDC	XXD	9H01 (DV6TED4)	D4164T	DV6	DV6TED4 (9HY/9HZ/9HX)	G8DA	G8DB
G8DC	G8DD	G8DE	G8DF	GPDA	GPDB	GPDC	HHDA	HHDB
HHJA	HHJB	HHJC	HHJD	HHJE	HHJF	MTDA	MZCD (Y6)	NGCA
NGDA	NGDB	T1BA	T1BB	T1BC	T1WA	T1WB	T3CA	T3CB
T3CC	T3DA	T3DB	T3JA	T3JB	TZGA	TZGB	TZJA	TZJB
U3CA	UBGA	UBJA	W16	D16 (9HZ)	Y6	DW10	DW12	



OM 3748

TIMING TOOLS MINI/PSA 1.4-1.6 VTI - THP16V PETROL AND TURBO

Suitable for engines equipped with a turbo.

Models:

Mini: One (R56), Mini Cooper (R55/R56)
 Citroën: C3, C4, C4 Picasso, C5III, DS3
 Peugeot: RCZ, 207, 308, 3008, 5008
Engines: 1.4 VTI, 1.6 VTI, 1.6 THP

COMPATIBLE ENGINE CODES					
Mini	N12 B14AB	N12 B16A	N14 B16A		
Citroën	8FR (EP3)	5FS (EP6)			
Peugeot	EP3 (8FS)	EP6 (5FV)	EP6DT (5FX)	8FS (EP3)	EP6DTS (5FY)

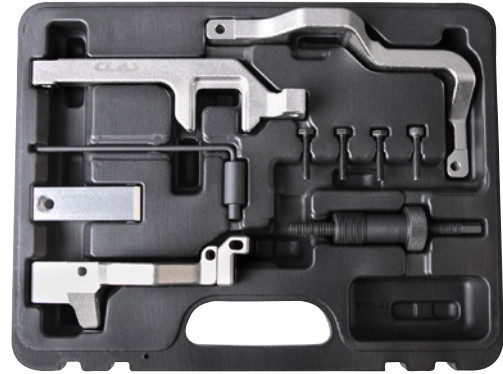

OM 3756

PSA/FIAT/FORD BELT TENSION WRENCH 1.4-1.6 DIESEL

Models:

Peugeot: 206, 207, 207cc, 308, 308cc, 508, 3008, 5008, Partner III
 Citroen: C1, C2, C3, C3 I/II/First/Classic/Pluriel/Picasso, C4, C4 Picasso/Grand Picasso, C5 III, Xsara II/Picasso, Berlingo, Berlingo First, DS3, DS4
Engines: 1.4-1.6D

Codes OEM :

0188-Z , G.0194-E3



OM 3767

TIMING TOOLS BMW 1.6-2.0 PETROL (N43)

Models : 116i, 118i, 120i (E81/82/87/88), 316i, 318i, 320i (E90/91/92/93), 520i (E60/61)
 Moteur : N43

Codes OEM :

11 3 340 , 11 5 120 , 11 8 690 , 11 8 691 , 11 8 692 , 11 8 693 , 11 8 700 , 11 8 710 , 11 8 711 , 11 8 712 , 11 9 340 , 11 9 341 , 11 9 342

COMPATIBLE ENGINE CODES			
B16	B16AA	B16OO	B20A
B20AA	B20AY	B20KO	B20UO

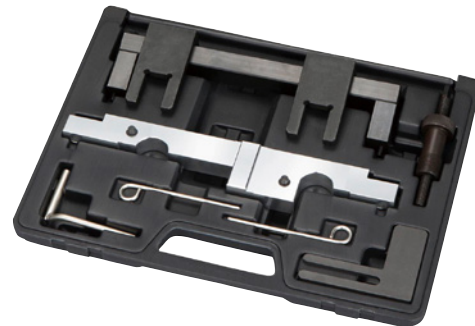

OM 3697

TIMING TOOL SET 1.3 Tce

Models :

Renault: Arkana (XJC) (19-), Capture (J87) (13-19), Captur II (XJB) (19-), Clio V (XJA) (19-), Kadjar (HFE), Koléos II (HZG) (17-), Mégane IV (BFB/KFB/LFF) (16-), Scénic/Grand Scénic IV (JFA/RFA) (16-), Talisman (KFD/LFD)(15-).
 Mercedes: A-Class (177) (18-), B-Class (247) (19-), CLA Coupe (118) (19-), CLA S/Frein (118) (19-), GLA (247) (20-), GLB (247) (19-).
 Nissan : Qashqai (J11) (14-), X-Trail (T32)(14-).
 Dacia : Dokker (F/K67), Plumeau (HJD) (17-), Lodgy (J92).

Codes OEM :

282 589 00 23 00 , 282 589 00 23 01 , 282 589 00 23 02 , 282 589 00 23 03 , 282 589 00 40 00

COMPATIBLE ENGINE CODES			
282.914	H5H 450	H5H 470	H5H 480
H5H 490	HR13DDT		

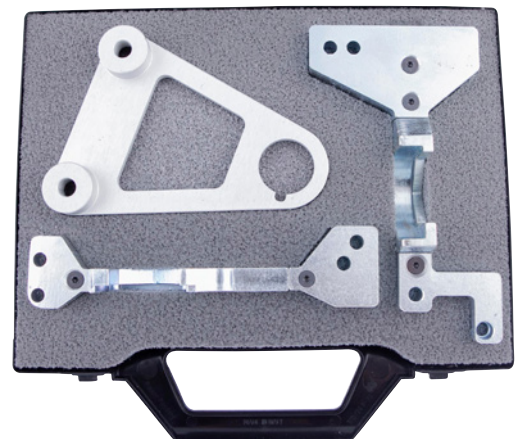

OM 3777
**TIMING TOOLS 1.4-1.6 HDI-TDCI 1.8-2.0
PETROL-DIESEL**
Models:

Fiat/Lancia: Scudo, Zeta, Phedra
 Ford: Fiesta, Fusion, Focus, Focus C-Max
 Citroën: C1, C2, C3, C3 Pluriel, C4, C4 Picasso, C5, C6, C8, DS3, DS4,
 Xantia, Xsara, Xsara Picasso, Evasion, Berlingo,
 Jumpy, Jumper, Saxo, ZX, XM, Evasion, AX
 Peugeot: 107, 1007, 206 cc, 207, 208, 306, 307 cc, 308, 406, 407,
 607, 806, 807, Partner, Expert, Boxer, 206, 106, 605, 205, 405

Engines:

Fiat/Lancia: 2.0 16V
 Ford: 1.4 -1.6 Duratorq TDCI
 PSA: 1.4 -1.6 HDI, 1.8, 1.8 16V, 2.0, 2.0 turbo, 1.8 16V, 2.0 16V

Codes OEM :

0132-AB, 0132-AJ1, 0153-G, 0178-E, 0188-M, 0188-Q2, 0189-J, 0189-R,
 0189-S1, 0189-S2, 0194-A, 0194-C, 21-262, 303-734, 4200-TH, 4507-TB,
 4533-TAC1, 5711-TA

COMPATIBLE ENGINE CODES

Fiat/Lancia	EW10				
Ford	FJ6A	F6JB	F6JC	G8DA	G8DB
	HHDA	HHDB	HHJA	HHJB	
PSA	EW7J4 (RLZ)	EW10A (RFJ)	EW10J4S (RFK)	EW10D (RLZ)	EW12J4 (3FZ)
	ET3JE (KFU)	TU3A/JP (KFV/ KFW)	DV4TD (8HW/8HX/8HZ)	DV4TED4 (8HV/8HY)	DV6ATED4 (9HX/9HY/9HZ)
	EW10-CVI (RLZ)	EW12 (3FZ)	DW8 (WJZ/WJY)	DW10 (RHY/RHV/RHZ/RHS/RHM/ RHW/RHT/RHR/RHX)	
	DW12 (4HX/4HZ/4HW/4HY)	EW7J4 (6FZ)	EW10J4 (RFR)	EW10J4D (RLZ)	
	EW10J4 (RFR)	EW10J4D (RLZ)			

OM 3789
**FREEWHEELING ALTERNATOR PULLEY
DISMANTLING KIT (30 PCS)**

Series of sleeves and locknuts, allowing the disassembly of
 the disengageable alternator pulley (dismantled or directly on
 the vehicle).

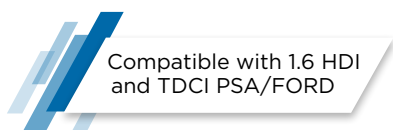

Applications: Renault, Peugeot, Citroën, VAG, BMW, Mercedes,
 Opel, Ford, Fiat, Toyota, Honda, Porsche...



OM 3858

TIMING TOOLS BMW/ROVER/OPEL DIESEL WITH CHAIN DRIVE

Models:

BMW: 116 E81/82/87/88 (08-12), 118 E81/82/87/88 (04-14), 120 E81/82/87/88 (04-14), 123 E81/82/87/88 (07-14), 316 E90/91/92/93 (09-12), 318 Compact E46 (01-05), 318 E90/91/92/93 (05-12), 320 Compact E46 (98-05), 320 E90/91/92/93 (05-12), 325 E90/91/92/93 (02-14), 330 E46/90/91/92/93 (99-14), 335 E90/91/92 (06-11), 520 E39/60/61 (00-10), 525 E39/60/61 F10-11 (00-12), 530 E46/60/61 F10/11 (98-13), 530GT F07 (09-12), 535 E60/61 F10-11 (04-12), 535GT F07 (10-12), 635 E63/64 (07-11), 730 E38/65/66 F01/02/04 (98-12), 740 F01/02/04 (09-12), 740 xDrive F01/02/04 (09-12), X1 sDrive E84 (09-12), X1 xDrive E84 (09-14), X3 E83 (03-10), X3 xDrive E83 (08-12), X5 E53/70 (00-12), X5 xDrive E70 (10-13), X6 E71/72 (08-10), X6 xDrive E71/72 (10-14)

Mini: Mini (10-14), Clubman (10-14), Clubvan (12-14), Countryman (10-14), Paceman (13-14), Roadster (12-14)

Land Rover: Freelander TD4 (00-06), Range Rover TD6 (02-06)

Rover-MG: MG-ZT/T (01-05), 75 CDT/CDTI (99-05)

Opel: Omega B (01-03)

Engines: 1.6, 1.8, 2.0, 2.3, 2.5, 3.0, 3.5, 4.0 diesel



COMPATIBLE ENGINE CODES

	M47	M47T2	M57	M57T2	M57TU
BMW-Mini	N47/N47S (C16K1, C16U1, C20K1, C20U1, D20A, D20B, D20O0, D20T0, D20U0)				
	N57 D3000	D3001	D30T0	D30U0	
Land Rover	204D3 TD4	306D1 TD6			
Rover-MG	M47R				
Opel	Y25DT				



OM 4005

TIMING TOOLS RENAULT/NISSAN

Models:

Renault: Clio 2-3-4, Clio Sport 2-3, Mégane 2-3, Mégane Scenic 1-2-3, Vel Satis 1-2, Avantime, Kangoo 2-3, Laguna 1-2-3, Espace 2-3, Modus, Koleos

Dacia: Logan, Duster, Sandero, Dokker

Nissan: Note, Qashqai, Micra, Kubistar, Almera, Primera

Engines: 1.4 16V, 1.6 16V, 1.8 16V, 2.0 16V, 2.0 16V turbo, 1.5 DCI

Codes OEM :

KV113 B0130 , MOT 1489 , MOT 1490-01 , MOT 1496 , MOT 1750

COMPATIBLE ENGINE CODES

K4M700	K4M701	K4M704	K4M706	K4M707	K4M708	K4M709	K4M710	K4M711	K4M712	K4M714
K4M716	K4M718	K4M720	K4M724	K4M730	K4M732	K4M734	K4M736	K4M740	K4M742	K4M743
K4M744	K4M745	K4M746	K4M748	K4M750	K4M752	K4M753	K4M754	K4M760	K4M761	K4M762
K4M764	K4M765	K4M766	K4M768	K4M776	K4M782	K4M788	K4M790	K4M791	K4M794	K4M800
K4M801	K4M802	K4M804	K4M812	K4M813	K4M830	K9K700	K9K702	K9K704	K9K706	K9K710
K9K712	K9K714	K9K716	K9K718	K9K722	K9K724	K9K728	K9K729	K9K732	K9K734	K9K740
K9K750	K9K752	K9K760	K9K762	K9K764	K9K766	K9K768	K9K802	K9K804	K9K806	F4P
F4R	K4J700	K4J710	K4J711	K4J712	K4J713	K4J714	K4J715	K4J730	K4J732	K4J740
K4J750	K4J770	K4J780								



OM 4010

TIMING TOOLS VAG 1.2 PETROL

Models:

VW: Fox, Lupo, Polo

Skoda: Fabia, Roomster

Seat: Ibiza, Cordoba

Engines: 1.2 6V, 1.2 12V (petrol engines with chain)

Codes OEM :

T10120 , T10121 , T10123

COMPATIBLE ENGINE CODES

AWY	AZQ	BME	BBM	BMD	BXV	BZG
CEVA	CGPA	CGPB	CGPC	CHFA	CHFB	



OM 4012
**TIMING TOOLS 1.3L HDI - JTD
- MULTIJET - TDCI - CDTI**
Models:

Alfa: 145, 146, 147, 156, 159, 166, GT, Crosswagon Q4
Fiat: Punto, Grande Punto, Bravo/Brava, Marea, Weekend, Stilo,
Doblò/Cargo, Multipla, Idea, Panda
Lancia: Ypsilon, Musa, Lybra, Thesys
Opel: Corsa, Agila, Meriva, Combo Tour, Astra, Zafira, Vectra
Suzuki: Ignis, Swift, Wagon R+
Ford: Ka

Engines: 1.3 JTD MultiJet, 1.3 CDTI, 1.3 TDCI, 1.6 MultiJet, 1.9 JTD, 1.9 MultiJet, 2.4 JTD, 1.9 CDTI, 2.0 MultiJet

Codes OEM :

1860905000, 1860905010, 1860985000, 1870896900, 1870900300,
1870900400, 1871000900, 199B303-1059, 303-1468, EN-46781, EN-46788,
EN-46789, KM-6130, KM-6349, KM-933

COMPATIBLE ENGINE CODES

169A1.000	955A4.000	350A3.000	192B4.000	198A2.000	350A2.000	955A3.000	192A8.000
198A6.000	198A3.000	199B1.000	199B2.000	199A2.000	199A3.000	199A9.000	940A3.000
188A3.000	939A2.000	188B2.000	188A8.000	188A9.000	323.02	371.01	937A2.000
182B4.000	182B9.000	188A2.000	188A7.000	192A9.000	186A6.000	186A8.000	192A1.000
192A3.000	192B1.000	192A5.000	186A9.000	939A1.000	199A5.000	223A7.000	223A9.000
342.02	362.02	841G.000	841H.000	841P.000	939A3.000	185A2.000	185A6.000
Z13DT	Z13DTJ	Z13DTH	Z19DT	Z19DTH	Z19DTJ	Z19DTL	A13DTE
A13DTC	A13DTR	D13A	Y13DT	Y13DTH	Z13DTi	Z13DTH	Z13DTR

OM 4015
TIMING TOOLS FIAT 1.2-1.4 16V PETROL

Models: Punto, Bravo, Brava, Marea, Palio Weekend, Stilo
Engines: 1.2 16V, 1.4 16V

Codes OEM :

1860985000 , 1860987000 , 1860992000 , EN-46781

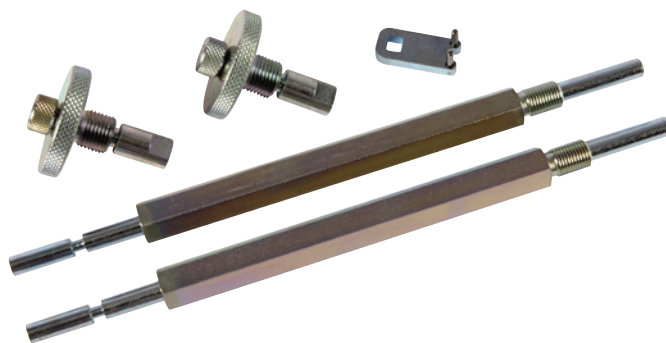
COMPATIBLE ENGINE CODES

176B9.000	182B2.000	188A5.000	843A1.000	169A3.000
192B2.000	198A1.000	198A4.000	199A6.000	199A8.000
312A1.000	312A3.000	940A6.000	940B1.000	940B7.000
940B8.000	955A1.000			

OM 4017
TIMING TOOLS FIAT/LANCIA/FORD PETROL
Models:

Fiat: Idea, Punto, Grande Punto, Stilo, Panda, 500, Bravo, New
Punto, Punto Evo, New Panda
Lancia: Ypsilon, Musa
Ford: Ka

Engines: 1.2 8V, 1.2 16V, 1.4 8V, 1.4 Bi-Fuel LPG, 1.4 Natural Power
CNG, 1.2 Easy Power LPG, 1.2 Bi-Fuel LPG, 1.2 Evo

Codes OEM :

1860905000 , 2000004200 , 2000004300 , 2000004400 ,
2190754200 , 2190754400 , 2190754500

COMPATIBLE ENGINE CODES

350A1.000	169A4.000	188A4.000	199A4.000	199A7.000
-----------	-----------	-----------	-----------	-----------



OM 4018

TIMING TOOLS VW/AUDI/SEAT/SKODA PETROL-DIESEL

Models:

Audi: 80, A2, A3, A3 Cabrio, A4, A4 quattro, A5, A5 Coupe/Cabriolet, A6, A6 quattro, TT, Q5

Seat: Ibiza, Altea, Altea XL, Arosa, Ibiza/Cordoba, Inca, Leon, Toledo, Alhambra

Skoda: Exeo, Fabia, Fabia II, Felicia, Roomster, Octavia, Octavia Tour, Octavia II, Superb, Superb II

VW: Lupo, Polo, Polo/Classic, Fox, Golf/Bora, Golf/Plus, Jetta, Jetta III, Eos, Beetle, New Beetle, Scirocco, Tiguan, Passat, Passat CC, Touran, Sharan, Caddy, Vento, Caddy Maxi, Golf Estate, Sharan, Transporter

Engines: 1.2 TDI PD, 1.4 TDI PD, 1.7 SDI, 1.9 D/Turbo, 1.9 SDI, 1.9 TDI, 1.9 TDI PD, 2.0 TDI PD, 2.5 TDI

Codes OEM :

2064, 2065A, 23-058, 23-059, 23-059, 2587, 310-084, 310-085, 3242, 3359, 3387, 3458, MATRA V.159, MPI-1312, MPI-301, T00115, T10008, T10016, T10020, T10050, T10050, T10074, T10074, T10098, T10100, T10264, T20038, T20038, T20102, T30052, T30094, T40069, T40098, U20003, U30009A, U40021



COMPATIBLE ENGINE CODES							
AJM	AMF	ANU	ANY	ARL	ASZ	ATD	ATJ
ATL	AUY	AVB	AVF	AVQ	AWX	AXB	AXC
AXR	AYZ	BAY	BDK	BGW	BHC	BHW	BJB
BKC	BKD	BKE	BKP	BLS	BLT	BMR	BMS
BMT	BNM	BNV	BPX	BRB	BRM	BRR	BRS
BRU	BSU	BSV	BSW	BTB	BUK	BVK	BWB
BWV	BXE	BXF	BDJ	BLB	BMM	BMN	BMP
BMR	BNA	BPW	BRC	BRE	BRF	BRT	BSS
BVH	BWV	AHB	AHG	AKU	AKW	1X	1Y
AAZ	ABL	AEF	AEY	AGD	AGP	AQM	ASX
ASY	AYQ	1Z	AFF	AFN	AGR	AHF	AHH
AHU	ALE	ALH	ASV	AVG	AFB	CKUB	



OM 4025

TIMING TOOLS FIAT 2.3 JTD

Applications:

Brands: FIAT, IVECO

Models: Ducato, daily

Engines: 2.3 JTD, 3.0 JTD, 3.0 HPI

Codes OEM :

1860617000 , 2.000018200 , 99360614 , 99360615

COMPATIBLE ENGINE CODES				
FIAE0481C	FICE0481D	FIAE0481A	FIAE0481B	FICE0481A



OM 4029
SINGLE PULLEY STRETCH BELT INSTALLATION AND REMOVAL TOOL

This tool is necessary for fast and easy installation and removal of the trapezoidal stretch belt without damaging it. Designed for single pulley engines.

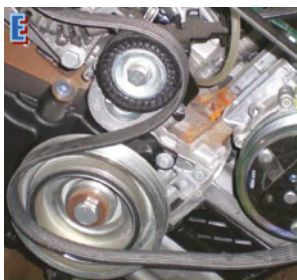
OM 4032
TIMING TOOLS VAG 2.7-3.0- 4.0 TDI
Models:

Audi: A4, A5, A6, A8, Q5, Q7
VW: Touareg, Phaeton

Engines: 2.7-3.0-4.0-4.2 TDI CR

Codes OEM :

3242 , 3359 , T20102 , T40049 , T40058 , T40060 , T40061 , T40062

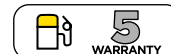

COMPATIBLE ENGINE CODES						
BPP	BSG	CANA	CANB	CANC	CAND	ASB
BKN	CAPA	BNG	BMZ	BUG	ASE	BMK
CARA	BKS	BUN	CASA	CASB	CASC	CAMA
CAMB	CGKA	CGKB	CCWB	CCWA	CCLA	CDYA
CDYB	CDYC	CEXA	BVN	BTR	CCFA	

OM 4036
TIMING TOOLS FIAT/ALFA/LANCIA/OPEL
Models:

Alfa: 145, 146, 147, 156, 166, GT

Fiat: Punto, Grande Punto, Brava/Bravo Marea, Weekend, Stilo, Doblo/Cargo, Multipla

Lancia: Lybra, Thesys

Opel: Vectra, Zafira, Astra, Insignia, Signum

Engines: 1.6 MultiJet, 1.9 JTD, 1.9 MultiJet, 2.4 JTD, 1.9 CDTI, 2.0 MultiJet

Codes OEM :

1860905000 , 21-229 , 21-238 , 303-651 , 303-679A , 323-029 , EN-46788



COMPATIBLE ENGINE CODES					
3323.02	371.01	182B4.000	182B9.000	186A6.000	188A2.000
188A7.000	188B2.000	186A8000	192A1.000	192A3.000	937A2.000
939A1.000	192A5.000	192B1.000	198A5.000	937A5.000	939A2.000
325.01	342.02	362.02	185A6.000	841C.000	841G.000
939A3.000	940A3.000	940A4.000	940A5.000	Z19DT	Z19DTH
Z19DTR	Z19DTJ	Z19DT			

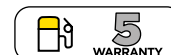

OM 4037

TIMING TOOLS VAG 1.6-2.0 TDI

Models:

Audi: A3, A4, Q5, A6

VW: Golf, Golf plus, Passat, Tiguan

Seat: Exeo

Engines: 1.6D TDI CR, 2.0D TDI CR

Codes OEM :

3359 , T10050 , T10051 , T10052 , T10100 , T10255 , T10264 , T10265 , T20102 , T40098



COMPATIBLE ENGINE CODES						
CAAA	CAAB	CAAC	CAGA	CAGB	CAGC	CAHA
CAHB	CAVA	CAYB	CAYC	CBAA	CBAB	CBAC
CBBB	CBDA	CBDC	CBDD	CCHA	CFFB	FCA



OM 4039

TIMING TOOLS FIAT/ALFA 1.4 MULTI AIR PETROL

Models:

Alfa Romeo: Mito, Giulietta

Fiat: Punto Evo, 500

Engines: 1.4 Multiair 105, 1.4 Multiair 135 Turbo, 1.4 Multiair 170 Turbo

Codes OEM :

1860905000 , 1860905010 , 1860987000 , 2000004200 , 2190754200 , 2190754500 , 312A1000 , EN-46788

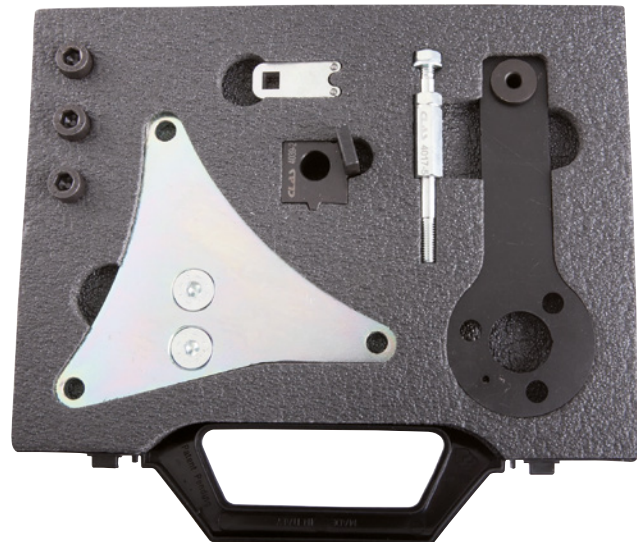

COMPATIBLE ENGINE CODES		
955A6.000	955A2.000	955A7.000
940A2.000	955A8.000	312A1000



OM 4044
UNIVERSAL BELT PULLEY PULLER QUICK APPROACH Ø47-110mm

For the extraction of camshaft pulleys 2,3,4,6 and 9 arms. Also suitable for crankshaft pulleys/damper pulleys with threads in M8x1.25 and M10x1.5 and some flywheels.

Delivered with:

- claw set 1.5DCI (SA4046)
- claw set M8x1.25 L. 50mm
- claw set M10x1.5 L. 50mm

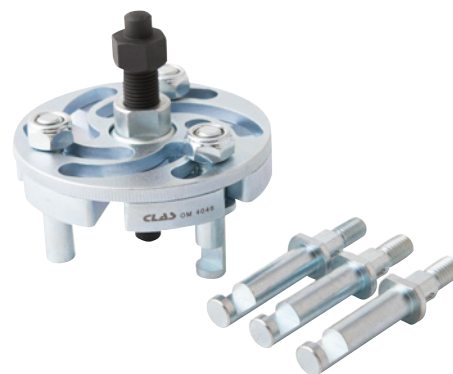
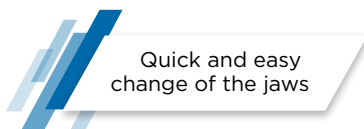
OM 4047
UNIVERSAL BELT PULLEY PULLER QUICK APPROACH+ 1.5 DCI CLAW

Contents:

OM 4046: universal belt pulley puller quick approach Ø48-Ø82mm
SA4046: pulley puller jaws set for 1.5 DCI

Codes OEM :

MOT 1525

OM 4051
TIMING TOOL VW 1.2-1.4 TSI

Sealey - VAG 1.2, 1.4 TSi belt driven petrol engine adjustment/locking kit.
Suitable for the latest VAG 1.2, 1.4 TSi belt driven petrol engines, including the 1.4 TSi ACT.

Contains the essential tools for locking the camshaft and crankshaft for timing belt replacement.

Models:

Audi: A1 (12-18), A1 Sportback (12-18), A3 (13-18), A3 Sportback (12-17), A3 Cabriolet (14-17), Q2 (16-18), Q3 (15-18)

Alhambra (15-17), Ateca (16-18), Ibiza (12-17), Leon (12-18), Leon ST (14-18), Toledo (12-17)

Skoda: Fabia (10-13), Fabia III (14-17), Octavia II (10-13), Octavia III (10-18), Rapid (15-17), Rapid Spaceback (15-17), Yeti (15-17), Yeti Outdoor (15-17)

VW: Golf VII (08-17), Golf VII Estate (08-17), Golf Sportsvan (14-15), Jetta (12-17), Polo (12-17)

Codes OEM :

T10340 , T10499 , T10494 , T10504 , T10060A

COMPATIBLE ENGINE CODES						
CJZA	CJZB	CJZC	CJZD	CYVA	CYVB	CGGA
CHPA	CHPB	CKSB	CMBA	CPVA	CPWA	CRJA
CUKB	CUKC	CYVB	CXSA	CZDA	CZDB	CZEA
ACT	CPTA	CWVA	CWVB			



OM 4053

**TIMING TOOL ALFA/FIAT/LANCIA
0.9 TWIN AIR PETROL**

Models:
Alfa Romeo: Mito (2012-15)
Fiat: 500, 500C, 500L (2010-15) Panda (2012-15), Punto (2012-15)
Lancia: Ypsilon (2011-15)
Engines: 0.9 Twin Air Turbo
Engine codes: 312A2.00

Codes OEM :
2000035100 , 2000035200 , 2000035300 , 2000038300

COMPATIBLE ENGINE CODES				
312A2000	312A4000	312A5000	312A6000	312A7000



OM 4055

ADJUSTMENT KIT VAG 2.5 PD TDI

Models: Touareg, Transporter
Engines: 2.5 TDI PD
Codes OEM :
T10193 , T10194 , T10195 , T10199 , T10199/1 , T10200 , T10226 ,
T10234 , T10255

COMPATIBLE ENGINE CODES				
AXD	AXE	BAC	BLJ	BLK
BNZ	BPC	BPD	BPE	



OM 4057

TIMING TOOLS VAG 1.4-1.6-2.0 CR TDI

Models:
Audi : A1, A3 Cabrio, A3, A3 Sportback, A4, A4 Allroad, A4 Quattro, A5 Coupé, A5 Cabrio, A5 Sportback, A6, TT, Q5
Skoda : Octavia III
Seat : Leon, Leon ST
Volkswagen : Polo, Golf VII, Golf VII Estate, Golf VII Wagon, Golf SV, Golf Sportsvan
Moteurs : 1.4 CR TDI, 1.6 CR TDI, 1.6 CR TDI GreenLine, 1.6 CR TDI Ecomotive, 1.6 CR TDI BlueMotion, 2.0 CR TDI, 2.0 CR TDI Ultra, 2.0 RS CR TDI, 2.0 CR GTD
Codes OEM :
3359 , T10051 , T10060A , T10264 , T10265 , T10490 , T10492

COMPATIBLE ENGINE CODES							
CKFB	CKFC	CLHA	CLHB	CNHA	CNHC	CRBC	CRBD
CRFA	CRFC	CRKA	CRKB	CRLB	CRLC	CRMB	CRVA
CRVC	CSUA	CSUB	CUNA	CUPA	CUSA	CUSB	CUTA



OM 4069

**RIBBED PULLEY PULLER WITH
INTERCHANGEABLE ARMS +
OFFSET ARMS KIT**

Contents:
• OM4067: ribbed pulley puller with interchangeable arms
• SA4067: offset arms kit + thrust screw L.180mm



OM 4070
COFFRET CALAGE PSA/LAND ROVER/JAGUAR 2.7/3.0 V6 (TDV6)
Models:

Citroën: C6, C5

Peugeot: 407, 607, 407 coupé

Land Rover: Range Rover Sport, Discovery 3, Discovery 4

Jaguar: S-Type, XJ Series

Engines: 2.7 TDV6, 2.7 D, 2.7 HDI, 3.0 SDV6/TDV6

Codes OEM :

0195-H , 303-1116 , 303-1117 , 303-1126 , 303-1132

COMPATIBLE ENGINE CODES

276DT	276DT (7B/TG)	DT17TED4 (UHZ)
AJ-V6D/306DT	DT20CTED4 (X8Z)	306DT

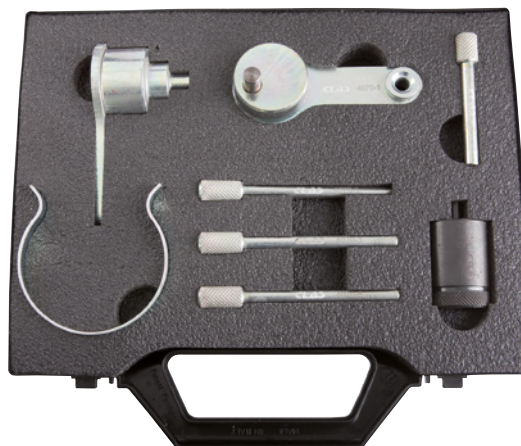
OM 4073
BMW M3 4.0 V8 (S65) TIMING TOOL SET
Models: M3 E90, M3 E92

Engines: 4.0 V8

Codes OEM :

11 5 290 , 11 5 292 , 11 5 320 , 11 5 370 , 11 9 970

COMPATIBLE ENGINE CODES

S65

OM 4074
BMW 4.4 TIMING TOOL SET PETROL
Models:

BMW : 550i (F10), 550i xDrive (F10), 550i Sedan (F10), 550i GT (F07), 550i Gran Turismo (F07), 550i xDrive Gran Turismo (F07), 650i Coupe (F13) 650i xDrive Coupe (F13), 650i Convertible (F12), 650i xDrive Convertible (F12), 750i (F01), 750i xDrive Sedan (F01), 750Li (F02), 750Li xDrive Sedan (F02), Active Hybrid 750i (F04), Active Hybrid 750Li (F04), X5, X5 M, X6, X6 M

Alpina : B7 (F01), B7 xDrive (F01), B7 LWB (F02), B7 LWB xDrive (F02)

Engines : 4.4 petrol

Codes OEM :

11 8 570 , 11 8 890 , 11 9 190 , 11 9 891 , 11 9 892 , 11 9 893 , 11 9 900

COMPATIBLE ENGINE CODES

N63	S63	N74
-----	-----	-----



OM 4075

CRANKSHAFT LOCKING TOOL PULLEY BMW M47

Ideal wrench for easy loosening and tightening of damper pulleys for BMW engines.

Models:

BMW : E81 120D (163 cv), E46 318D (115 et 116 cv), 318TD (115 cv), E46 320D (136 & 150 cv), 320TD (150 cv), E90 318D (150 cv), 320D (150 & 163 cv), E91 318D (122 cv), 320D (150 & 163 cv), E39 520D (136 cv), E60 520D (150 & 163 cv), E61 520D (150 & 163 cv), E83 X3 2.0D (150 cv)

Suitable for crankshaft pulleys with BMW part numbers:

11 23 7 787 304, 11 23 7 790 921, 11 23 7 793 882, 11 23 7 801 977, 11 23 7 805 696

Codes OEM :

116310



OM 4077

BMW/MINI/PSA (N13/N18/EP6) TIMING TOOL SET PETROL

Models:

BMW: every vehicules equipped with N13 engine

Mini: every vehicules equipped with N18 engine

Citroën: 1.6

Peugeot: 1.6

Codes OEM :

11 7 440 , 11 9 340 , 11 9 590 , 0 496 709 , 197-A , 0197-B , 0197-BZ , 0197-M , 0197-N , 2 299 362

COMPATIBLE ENGINE CODES

B16A

B16M0



OM 4078

ADJUSTMENT KIT BMW 1.8-2.0 PETROL

Models: Serie 3 (E46)

Engines: 1.8-2.0 N42B18A, N46B18, N46B20A, N46B20B

COMPATIBLE ENGINE CODES

N42B18A

N42B20A

N46B18

N42B20

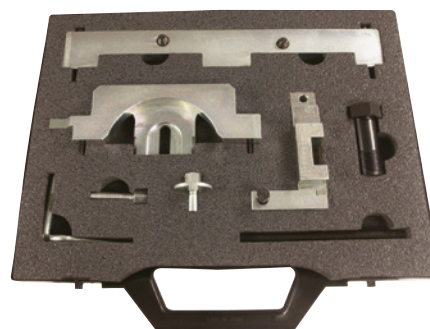

OM 4081

BMW 2.0 (N20/N26) TIMING TOOL SET PETROL

Models: 125i (12-14), 320i xDrive, 328i, 328i xDrive (12-14), 520i, 528i xDrive (11-14), X1 20i xDrive, X1 20i sDrive, X1 28i xDrive (11-14), X3 20i, X3 20i xDrive (11-14), Z4 20i sDrive, Z4 28i sDrive (11-14)

Engines: N20, N26

Codes OEM :

11 9 340 , 2219548 , 83 02 212 831 , 83 30 2 212 830

COMPATIBLE ENGINE CODES

N20B20A

N20B20

N26B20

N20B20/UO

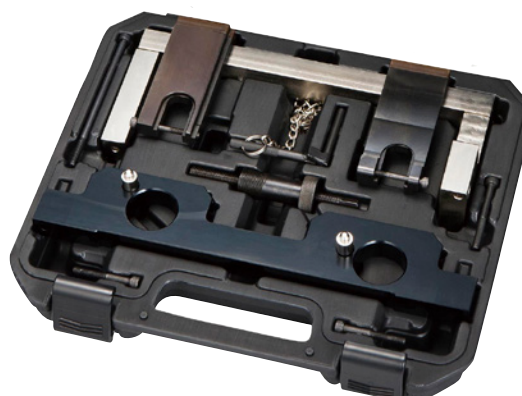

OM 4102
TIMING TOOLS PSA/FIAT 1.4-1.6-2.0-2.2-3.3-3.8
Models:

Fiat/Lancia: Ulysse, Scudo, Ducato, Zeta, Phedra
 Citroën: C1, C2, C3, C3 Picasso, C3 Pluriel, C4, C4 Picasso/Grand Picasso, C5, C6, C8, C-Crosser, DS3, DS4, DS5, Berlingo, Jumpy/Dispatch, Jumper/Relay, Nemo, Xantia, Xsara, Xsara Picasso, Evasion/Synergie, Saxo, ZX, XM, AX, C15
 Ford: Focus, C-Max, Focus C-Max, Kuga Transit
 Land Rover : Evoque, Defender
 Mitsubishi: ASX, Outlander 2, Lancer
 Hyundai: Genesis Coupé, IX55, Vera Cruz, Azera, Grandeur, Sonata, Sonica
 Kia: Opirus, Sorento
 Peugeot: 107, 1007, 206, 206+, 206 cc, 207, 207 cc, 208, 306, 307, 307 cc, 308, 308 cc, 3008, 406, 406 coupé, 407, 407 coupé, RCZ, 4007, 4008, 508, 5008, 607, 806, 807, Partner, Bipper, Expert, Boxer, 106, 605, 205, 405

Engines: 1.4 HDI, 1.6 HDI, 1.9, 2.0 JTD, 2.0 HDI, 2.2 TDCI, 2.2 JTD, 2.2 HDI, 2.2 DID, 2.4 TDCI, 3.2 TDCI 3.3 V6 petrol, 3.8 V6 petrol

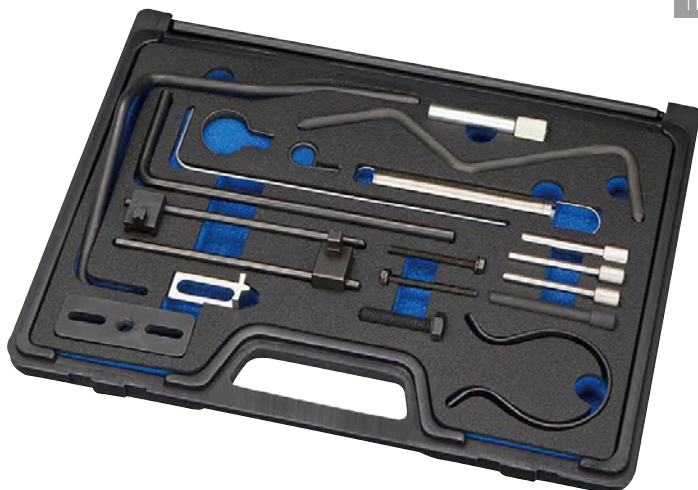

COMPATIBLE ENGINE CODES								
1.4L	DV4C (8HP)	DV4C (8HR)	DV4TD (8HT)	DV4TD (8HW)	DV4TD (8HX)			
	DV4TD (8HZ)	DV4TED (8HS)	DV4TED4 (8HX)	DW4TD (8HZ)				
1.6L	DV6ATED (9HX)	DV6ATED4 (9HX)	DV6AATED4 (9HX)	DV6BTED4 (9HT)	DV6BTED4 (9HW)	DV6BUTED4 (9HT)	DV6C (9HD)	DV6C (9HL)
	DV6C (9HR)	DV6D (9HP)	DV6DTE4 (9HF)	DV6DTE4 (9HJ)	DV6DTE4 (9HP)	DV6EATED (9HN)	DV6TED (9HY)	DV6TED4 (9HV)
	DV6TED4 (9HW)	DV6TED4 (9HX)	DV6TED4 (9HZ)	DV6TED4B (9HV)	DV6TED4BU (9HS)	DV6TEDB4 (9HS)	DV6TEDB4 (9HV)	
2.0L	DW10ATD (RHY)	DW10ATED (RHS)	DW10ATED (RHW)	DW10ATED (RHZ)	DW10ATED4 (RHM)	DW10ATED4 (RHW)	DW10ATED4/L4 (RHT)	DW10BTED (RHX)
	DW10BTED/L3 (RHX)	DW10BTED/L3 (RHZ)	DW10BTED4 (RHF)	DW10BTED4 (RHJ)	DW10BTED4 (RHL)	DW10BTED4 (RHR)	DW10C (RHD)	DW10C (RHH)
	DW10CTED4 (RH02)	DW10CTED4 (RHC)	DW10CTED4 (RHD)	DW10CTED4 (RHE)	DW10CTED4 (RHH)	DW10JATED4 (RHM)	DW10JATED4 (RHW)	DW10JTED4 (RHW)
	DW10ITD (RHY)	DW10ITD (RHZ)	DW10ITD (RHV)	DW10IATED4 (RHG)	DW10IATED4 (RHK)	DW10IFD (AHX)		
2.2L	DW12ATED (4HX)	DW12ATED (4HZ)	DW12ATED4/L4 (4HW)	DW12BTED4 (4HP)	DW12BTED4 (4HR)	DW12BTED4 (4HS)	DW12BTED4 (4HT)	
	DW12BTED4 (4HX)	DW12BTED4/L4 (4HW)	DW12CTED4 (4HL)	DW12MTED4 (4HK)	DW12MTED4 (4HN)	DW12TED4 (4HX)	DW12UTED (4HY)	
3.3-3.8L V6	G6DA	G6DB	G6DC					

OM 4105
TIMING TOOLS PSA/FORD/TOYOTA/OPEL 1.5 BLUEHDI
Models:

Citroën : Berlingo III, C3 III, C3 Aircross, C4 Cactus, C4 Spacetourer, C5 Aircross, Berlingo III Van, Traveller, Jumpy
 Peugeot : 208 II, 2008 II, 308 II, 308 III, 508 II, 3008 II, 5008 II, Rifter, Partner, Expert
 Opel : Corsa (F) VI, Mokka, Crossland, Grandland, Combo, Combo Cargo, Zafira, Vivaro
 Toyota : Proace City, Proace City Verso, Proace, Proace Verso

COMPATIBLE ENGINE CODES				
YHY / YH01 / DV5RD	YHZ / DV5RC	YHS / DV5RCE	YHT / YH01 / DV5RCF	YHR / DV5RUCD
D15DT / LQJ	D15DTH / LQP	F15DTH / LQP	YHV / DV5RUC	

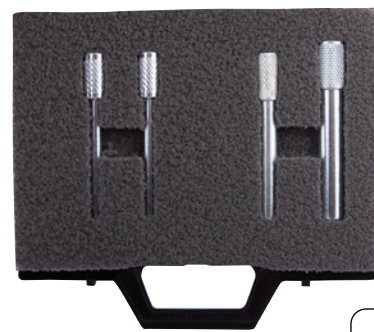
OM 4109
FORD 1.0 & 1.1 ECOBOOST TORQUE MULTIPLIER
Models:

Ford : Ford B-Max (2012-2018), Ford C-Max (2012-2018), Ford Grand C-Max (2017-2018), Ford EcoSport (2015-2019), Ford Fiesta (2012-2019), Ford Focus (2012-2018), Ford Mondeo (2015-2018), Ford Transit Courier (2014-2020), Ford Transit Connect (2013-2018), Ford Grand Tourneo Connect (2013-2018), Ford Tourneo Courier (2014-2020)

Codes OEM :

303-1611 , 303-1611-01 , 303-1611-02

COMPATIBLE ENGINE CODES														
B3DA	B7DA	MICA	MICB	MIDA	M1JC	M1JE	M1JH	M1JJ	M1JL	M1JM	M2GB	P4JA	P4JB	P4JC
MIDC	MIDD	MIDH	MIFA	M1JA	M1JP	M1JU	M2DA	M2DB	M2DC	M2GA	P4JD	SFCA	SFCB	SFCC
SFCD	SFDB	SFJA	SFJB	SFJC	SFJD	SFJE	SFJH	SFJJ	SFJK	SFJL	XMJA	XMJB	XMJC	XMJD
XPJA	XPJB	XPJC	XPJD	XYJA	XYJB	XYJC	XYJD	XYJE	YYJA	YYJB	YYJC	YYJD	YYJE	YYJF
YYJG														



OM 4112

TIMING TOOL KIT VAG 2.0 TFSI AND TSI

Models:
A3, A4, A6, Golf
Engines: 2.0 TFSI / FSI Chain

Codes OEM :
T10020, T40011, T10252, 3366, T10092, T00115



COMPATIBLE ENGINE CODES

AWA	AXW	AXX	BGB	BHD
BMB	BUL	BPY	BWA	



OM 4113

TIMING TOOLS VAG 1.8-2.0 FSI-TFSI-TSI

Models:
Audi: A4, A4 Quattro, A5 Coupe, A5 Cabriolet, A5 Sportback, A6, Q3, Q5, TT
Seat: Alhambra, Altea, Altea XL, Exea, Leon, Toledo
Skoda: Octavia II, Superb II, Yeti
VW: Eos, Golf VI, Golf VI Estate, Passat, Passat Alltrack, Passat CC, Sharan, Beetle, CC, Scirocco, Tiguan
Engines: 1.8 and 2.0 FSI-TFSI from 2006 to 2013

Codes OEM :
T10352/2, T10352/1, T10352, T10368, T40196, T10060A, T40011, T10354, T40267, T40271, T40265, T10355, T10170, VAS6079

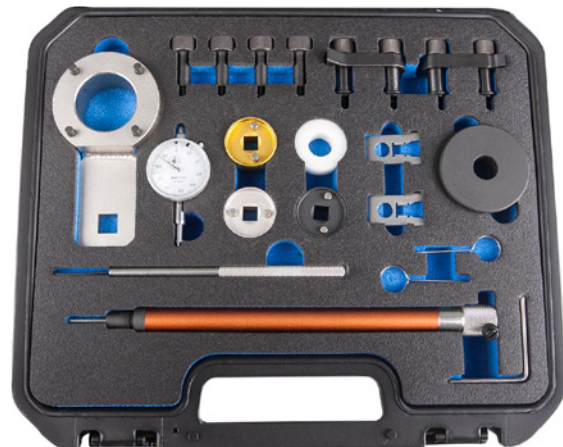

COMPATIBLE ENGINE CODES

CDAA	CDAB	CDHA	CDHB	CEAA	CGYA
CGEB	CCZA	CCZB	CCZC	CCZD	CDNB
CDNC	CDND	CESA	CETA	CPSA	CGMA
CCUA	BYJ	BYE	CDZA	CADA	



OM 4114

AUDI FSI TIMING TOOL SET

Models:
Audi A4, A6 B7 et C6
Engines: 2.4L, 3.2L V6, V8, V10

Codes OEM :
T40058, T40069, T40070, T40071



COMPATIBLE ENGINE CODES

AUK	BDW	BGP	BPK	BYU	BVJ
BKH	BNS	BYH	CAUA	BXA	BSM



OM 4117

TIMING TOOL SET FORD 1.0 ECOBOOST

Accessory for OM 4109

Models:
Ford : B-Max (2013-2017), C-Max (2012-2017), Connect (2013-2016), Courier (2012-2016), EcoSport (2013-2017), Fiesta (2013-2017), Focus (2012-2017), Grand C-Max (2012-2017), Grand-Tourneo Connect (2013-2015), Mondeo (2015-2017), Transit Connect (2015-2017).

Codes OEM :
303-732, 303-1064, 303-1065, 303-1602, 303-1604, 303-1606

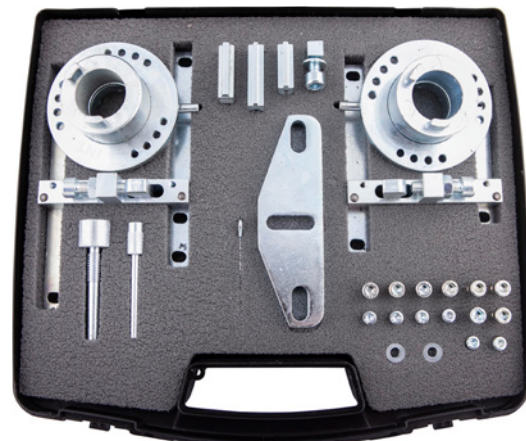

COMPATIBLE ENGINE CODES

FSCI	MICB	MIDA	MIDD	MIJA	MIJC
M1JE	M1JH	M1JJ	M2DA	M2DB	M2DC
M2GA	M2GB	P4JA	P4JB	P4JC	P4JD
SFCA	SFCB	SFDB	SFJA	SFJB	SFJD
XMJA	XMJB	XMJC	XMJD	MICA	



OM 4118
TIMING TOOL MAZDA/FORD 1.8-2.0-2.3 PETROL
Models:

Mazda : 3 MPS (06-13), 3 DISI (09-13), 5 DISI (10-13), 6 MPS (05-07),

6 DISI (10-13), CX-7 (07-12)

Ford : Mondeo (03-07)

Engines: 1.8, 2.0, 2.0

Codes: CFBA, LF (MZR DISI), MZR 2.0 (LF), L3 Turbo

OM 4121
TIMING TOOLS OPEL 1.6 CDTI
Models:

Opel / Vauxhall : Astra J, Meriva B, Mokka, Zafira C, Zafira Tourer

Engine: 1.6 ecoFLEX CDTI

Codes OEM :

EN-50513 , EN-51140 , EN-51143 , EN-6130 , EN-6349

COMPATIBLE ENGINE CODES

LVL/B16DTH	LVM/B16DTL	LVL/B16DTN	LVM/B16DTC
LWQ/B16DTE	LVL/B16	LVL/B16DTJ	

OM 4123
CAMSHAFT LOCKING KIT FOR OPEL PETROL
Models: Corsa B/C, Combo, Tigra, Tigra B, Meriva, Astra F, G, H, Speedster/

VX220, Zafira A/B, Vectra B/C, Signum, Omega B, Sintra, Frontera A/B

Engines: 1.4 16V, 1.6 16V, 1.8 16V, 2.0 16V, 2.2 16V

COMPATIBLE ENGINE CODES

X14XE	Z14XE	X16SEJ	X16XE	X16XEL	Y16XE
Z16XE	Z16YNG	C18XEL	X18XE	X18XE1	Z18XE
Z18XEL	C20SEL	C20XE	X20XEV	Z20LEH	Z20LEL
Z20LER	Z20LET	X22SE	X22XE	Y22SE	Y22XE
Z22XE					

OM 4126
TIMING TOOLS OPEL/FIAT/ALFA PETROL
Models:

Opel: Corsa D, Agila, Astra G/H/J, Meriva A, Zafira B/C Tourer,

Vectra C, Signum, Insigna

Chevrolet: Aveo, Cruze, Orlando

Fiat: Cromia, Stilo

Alfa Romeo: 159

Saab: 9-5

Engines: 1.4 16V, 1.6, 1.6 ecoFlex, 1.8

Codes OEM :

 2000012000 , 2000012100 , 2000012800 , 303-376 , 303-376B , EN-6333 ,
 EN-6340 , EN-6625 , KM-571-B , KM-6130 , KM-6333 , KM-6340 , KM-6349 ,
 KM-6349 , KM-6625 , KM-6628-A , KM-911 , KM-955

COMPATIBLE ENGINE CODES

G14D	A16LEL	A16LER	A16LET	A16XER	A16XNT
Z16XEP	Z16XER	Z16XE1	Z16LET	Z16LER	Z16LEL
Z16XNT	Z18XER	A18XER	A18XEL	192B3.000	939A4.000

OM 4127

CHRYSLER 2.8D TIMING TOOL SET

Models:

Jeep : Cherokee
Chrysler : Grand Voyager

Engines: 2.8D

Codes OEM :

VM.9991 , VM.9992



COMPATIBLE ENGINE CODES

ENS (51C)

VM64C

OM 4128

TIMING TOOL SET HYUNDAI KIA 1.6

Models:

KIA: Give way (18-), Optima (15-20), Procéder (19-), Sportage (16-21), Stonique (17-), XCEED (19-).
HYUNDAI : i40 (18-), Kona (17-), Tucson (15-21).

Codes OEM :

09240-2U100 , 09240-2U400 , 09240-2U300 , 09240-2U500

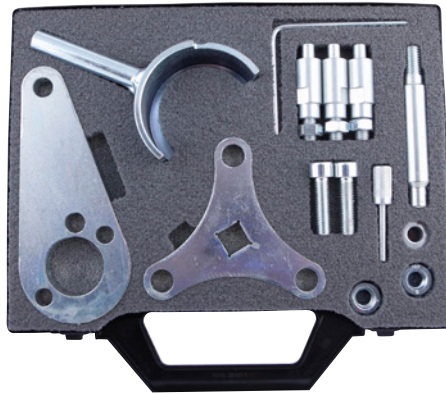

COMPATIBLE ENGINE CODES

D4FE

D4FE(U3)

OM 4131

TIMING TOOL SET FORD ECOBLUE 2.0 TDCI WITH PUMP INJECTION TOOL

Models :

FORD: Bord (18-21), Connect (18-), Galaxie (18-21), Kuga (19-), Mondeo (19-21), Ranger (19-), S-MAX (18-21), Transit (16-)

Codes OEM :

303-1643 , 303-1637 , 303-1650

COMPATIBLE ENGINE CODES									
AMRA	ANFA	BCCA	BCCB	BCCC	BCCD	BCDA	BCFA	BCFB	BCFC
BCFD	BCRA	BJFA	BJFB	BJFC	BJFD	BJRA	BJRB	BKFA	BKFB
BKFC	BKFD	BKRA	BKRB	BLFA	BLFB	BLFC	BLFD	BLHA	BLRA
BLRB	YL2X	YLCA	YLCB	YLCC	YLDA	YLF6	YLFA	YLFB	YLFS
YLR6	YLRA	YMCA	YMCB	YMCC	YMF6	YMFA	YMFB	YMFS	YMHA
YMR6	YN2X	YNCA	YNF6	YNFB	YNFS	YNR6	YNRA	BC2X	

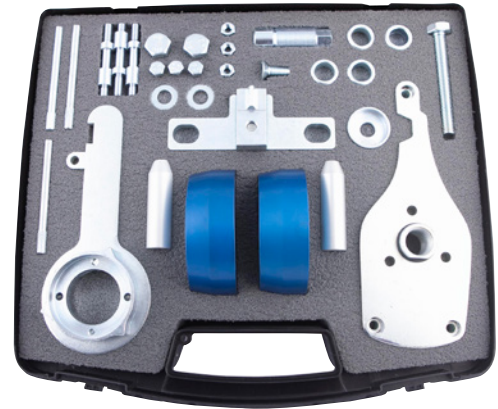

OM 4150

TIMING CHAIN BREAKER AND RIVETING TOOL

Allows for separation and reassembly of timing chains on most vehicles, transmission chains on quads and motorcycles...

Specifications:

- frame opening: 42mm
- rivet removers length: adjustable up to 25mm
- 22 and 14mm hexagonal drive

Contents:

- chain breaker
- 4 chain breaking tips: 3, 3, 4, 5mm
- 1 chain rivet tip
- 2 assembly plates



OM 4212
TIMING TOOL JAGUAR/LAND ROVER 2.0 PETROL
Models:

Jaguar: XE (2015-16), XF (2012-15), XJ (2013-16)
 Land Rover: Discovery Sport (2015-16), Freelander (2012-15),
 Evoque (2011-16)

Engines: 2.0 GTDi, Si4
 Engine codes: 204PT

OM 4214
TIMING TOOL KIT OPEL/VAUXHALL 1.0-1.2-1.4 TURBO
Applications:

Adam, Ampera, Astra-J, Aveo, Corsa-D, Insignia, Meriva-B, Mokka,
 Zafira-C Tourer

Codes OEM :

991238310 , EM952 , EN49977100 , EN49977200 ,
 EN49978 , KM952 , KM953A , KM955A1 , KM955A2

COMPATIBLE ENGINE CODES

A10XEP	A12XEL	A12XER	A14NEL	A14XEL	A14XER
L2Q/A12XEL	L2Z	LDC/A12XER	LDD	LDD/A14XEL	LDD/A14XER
LUH/A14NEL	LUJ/114NET	LUJ/A14NEL	LUJ/A14NET	LUU/A14XFL	LWD
LWD/A12XEL					

OM 4230
TIMING TOOL FORD/JAGUAR 2.0-2.2-2.4 DURATORQ
Contents:

- camshaft/crankshaft alignment pin
- chain tensioner
- fuel pump cover removal tool
- fuel injection pump pinion locking tool.

It includes the pins needed to lock the camshaft flywheel and align the crankshaft and fuel pump when checking valve timing on 2.0 and 2.4-litre chain-driven engines.

Codes OEM :

303732 , 21260 , 49JE02018 , 303679A , 3031151 , 303698 , 21251 ,
 303681 , 303675 , 21234 , 21-251 , 303-675 , 21-238A , 11 3 290 ,
 11 32 90 , 113290 , KM-6077 , T40011

COMPATIBLE ENGINE CODES

ABFA	D3FA	F3FA	D5BA	D6BA
FMBA	FMBB	FIFA	HJBA	HJBB
HJBC	HJBE	N7BA	N7BB	SDBA
QJBA	QJBB	QJBS	QJBD	D2FA
D4FA	DOFA	F4FA	FXFA	H9FA
H9FB	JXFA	PHFA	ZSD424	244DT

Models:

Ford: Focus, Mondéo, Transit
 Hyundai: Accent, Getz, I10, I20
 Kia: Cerato, Picanto, Rio
 Land rover: Defender

Engines: 2.0, 2.2, 2.4 TDdi/TDCi
 For engines built between 2002 and 2010



OM 4245

TIMING TOOL SET LAND ROVER 2.0 D

Models:

LAND ROVER : Discovery, Discovery Sport, Range Rover Evoque, Range Rover Evoque Cabriolet, Range Rover Sport, Range Rover Velar
 JAGUAR : E-Pace, F-Pace, XE, XF

Codes OEM :

JLR-303-1625 , JLR-303-1631 , JLR-303-1630 , JLR3031625 , JLR3031630 , JLR3031631

COMPATIBLE ENGINE CODES

204DT	204DTD	AJ-200D	AJ200	AJ200D
-------	--------	---------	-------	--------



OM 4471

HIGH PRESSURE PUMP REMOVAL TOOL HYUNDAI/KIA

Models: Kia: Carens, Ceed, Optima, Rio, Soul, Sportage, Venga
Engines: 1.1 TCI, 1.4 TCI, 1.4 CRDI, 1.6 TCI, 1.6 CRDI, 1.7 TCI

Codes OEM :

0104-B , 09331-2A010 , 1 871 008 600 , 303-1475



OM 4758

TIMING TOOLS PSA/BMW MINI W16D

Models:

Mini: Mini, Clubman
 Citroën: C2, C3, C3 Picasso, C4, C4 Picasso, Grand Picasso, Xsara Picasso, C5 II, C5 III, Berlingo III
 Peugeot: 206, 206 CC, 207, 207 CC, 307, 308, 308 CC, 1007, 3008, 5008, Partner III
Engines: 1.6 diesel

COMPATIBLE ENGINE CODES

DV6TED4 (9HX , 9HY , 9HZ)	W16D16 (9HZ)	W16D16UO
---------------------------	--------------	----------



OM 6250

CAMSHAFT ALIGNMENT SET AUDI TDI CR

Allows camshaft alignment. Incorrect alignment can cause damage to the camshaft housings, including the need to replace the cylinder head.

Models:

Audi: A1 , A1 Sportback, A3, A3 Sportback, A3 Cabrio, A4, A4 Allroad, A4 Quattro, A4 Cabrio, A5, A5 Sportback, A5 Cabrio, A6, A6 Allroad, A6 Quattro, A8, TT, Q3, Q5, Q7

Engines: 1.6-2.0-2.7-3.0-4.0-4.2 TDI CR

COMPATIBLE ENGINE CODES

	COMPATIBLE ENGINE CODES					
1.6L	CAYB	CAYC				
2.0L	CAGA	CAGB	CAGC	CAHA	CAHB	CBAA
	CBAB	CBBB	CFFA	CFFB	CFGB	CFGC
	CFGD	CFHB	CFHD	CGLA	CGLB	CGLC
	CGLD	CGLE	CJCA	CJCB	CJCC	CJCD
2.7 L	CLLB	CLJA	CMEA	CMFA	CMFB	CMGB
	BPP	BSG	CAMA	CAMB	CANA	CANB
3.0L	CANC	CAND	CGKA	CGKB		
	ASB	BKN	BMK	BNG	BUG	BUN
	CAPA	CASA	CASB	CCLA	CCMA	CCWA
4.0L	CCWB	CDYA	CDYB	CDYC		
	ASE					
4.2 L	BTR	BVN	CCFA	CCFC	CDSB	CTEC

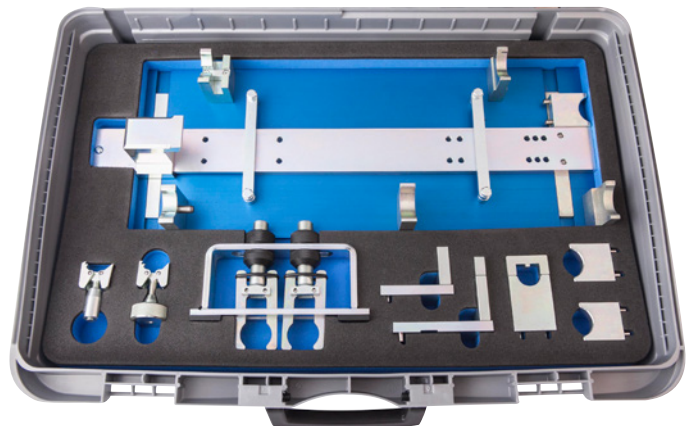

OM 9259
POLYGONAL WRENCH SET FOR TIMING PULLEY NUTS & ACCESSORIES (5 PCS)

These wrenches are specially designed for working on hard-to reach pulley nuts and belt tensioners.

Contents:

- I-shaped Ø19mm wrench
- I-shaped Ø17mm wrench
- I-shaped Ø16mm wrench
- I-shaped Ø15mm wrench
- I-shaped Ø13mm wrench



Low space requirement

OM 9260
TIMING TOOLS VAG/FORD DIESEL 1.2 TDI PD, 1.4-1.6-1.9-2.0 CR TDI-TDCI
Models:

From 2007 (square-tooth pulleys)

Audi: A2, A3, A3 Cabrio, A4, A4 4WD, A5 Coupe/Cabriolet, A6, A6 quattro, Q5, TT

Seat: Alhambra, Altea, Altea XL, Arosa, Cordoba, Ibiza, Leon, Toledo

Skoda: Exeo, Fabia, Fabia II, Octavia, Octavia Tour, Octavia II, Roomster, Superb, Superb II

VW: Beetle, Bora, Caddy, Caddy Maxi, Eos, Fox, Golf, Golf Plus, Golf Estate, Jetta, Jetta III, Lupo,

Passat, Passat CC, Polo, Scirocco, Sharan, Tiguan, Touran, Transporter

Ford: Galaxy

Engines: 1.2 TDI PD, 1.4 TDI PD, 1.6 TDI CR, 1.9 TDI PD, 2.0 TDI PD, 2.0 TDI CR

Codes OEM :

23-059 , 23-059 , 303-1054 , 310-085 , 3359 , MPI-301 , T10050 , T10100 , T10060 , T10060A , T10115 , T20102

COMPATIBLE ENGINE CODES

AFN	AHU	AJM	AMF	ANU	ANY	ARL	ASZ	ATD	ATJ	ATL	AUY
AVB	AVF	AVQ	AWX	AXB	AXC	AXR	AYZ	AZV	BAY	BDK	BGW
BHC	BHP	BHW	BJB	BKC	BKD	BKE	BKP	BLB	BLS	BLT	BMA
BMN	BMR	BMS	BMT	BNA	BNM	BNV	BPX	BRB	BRE	BRF	BRM
BRR	BRS	BRU	BSU	BSV	BSW	BTB	BUK	BUY	BUZ	BVA	BVE
BVF	BVG	BVK	BWB	BWV	BXE	BXF	CAGA	CAGB	CAGC	CAHA	CAYA
CAYB	CAYC	CBAA	CBAB	CBAC	CBBA	CBBB	CBDA	CBDB	CBDC	CBEA	CEGA

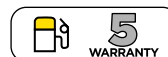
OM 9281
TIMING TOOLS PSA 1.0-1.1-1.4-1.6 -1.9
Models:

Citroën: AX, GTi, ZX, BX, C15, Visa Gti, Saxo 16V 1.6

Peugeot: 106, 205, 305, 309, 405, 309 Gti 16, 405 Mi 16

Engines: 1.0, 1.1, 1.4, 1.6, 1.9

Codes OEM :

0132-Q , 0132-QZ , 0132-X , 0153-AB , 0188-Q1 , 0194-C , 21-262 , 303-734 , 4507-TA , 4507-TJ , 9041-TZ , 9767-27 , 9767-89

COMPATIBLE ENGINE CODES

159A	171B	171C	171D	180A	180D	180Z	B1A/A	B1E	B1F
B4A	B6D	B6E	BAY	BDY	C1A	CDY	CDZ	D2A	D2C
D2E	D2F	D6A	D6B	D6D	D6E	DDZ	DFZ	DKZ	H1A
HDY	HDZ	K1A	K1F	K1G	K2A	K2B	K2D	K3A	K6B
KDX	KDY	KDZ	KFY	KFZ	M4A	NFU	NFX	T8A	T9A
THX	TU	TUI-2-3-5-9	VJY	VJZ	X12XE	XU	XU5-171B	XU9-D2A	

OM 9314
UNIVERSAL TIMING BELT PULLEY LOCKING TOOL

This tool is a toothed pulley locking kit designed to keep the pulley steady while replacing the timing belt.

This kit can be used on all engines with 1, 2 or 4 camshafts, and for injection pump pulleys. The main tool can be universal, and adapt to the pulleys distance by adjusting the gap thanks to its 2 guides. The flange can be used separately on an independent pulley.



POWERTRAIN

SPECIFIC TIMING TOOLS 1.2 PURETECH



TN

OM 3747

PSA 1.2 12V 3 CYLINDER PURETECH TIMING KIT

Accessory for OM 4141/OM 4142/OM 4058

This set will allow you to adjust the timing on Turbo engines only, without having to remove the cylinder head cover.

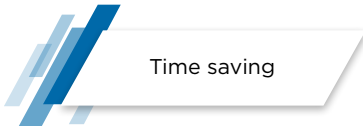

Time saving



Models:

Citroën : Berlingo 4, C3 IV, C3 Aircross, C4 Cactus, C4 III, C4 Space Tourer, C5 Aircross
Peugeot : 2008, 208, 308, 3008, 508, 5008, Partner
Opel : Combo-E (X19), Combo-E Life (X19), Crossland X (P17), Grandland X (A18)

Codes OEM :

0109 2B , 0109-2C , 0109-2D , 0197-N , J-0109-2C , J-0109-2D , EN-52127-1 , EN-52127-2 , EN-52588

COMPATIBLE ENGINE CODES

D12XHL	D12XHT	EB2ADT	EB2ADT(HNP)	EB2ADTD(HNK)	EB2ADTS	EB2ADTS(HNS)
EB2ADTX	EB2ADTX(HNN)	EB2DTS(HNY)	EB2LEG	EB2LES	F12LES	F12XHT

Also available for naturally-aspirated engines: timing tools PSA 1.0-1.2 3 cylinders Puretech



OM 4041

TIMING TOOLS PSA 1.0-1.2 3 CYLINDERS PURETECH

Accessory for OM 4058

This set is compatible with all PURETECH PSA 3-cylinder engines (atmospheric and turbo). This set requires the removal of the cylinder head cover.



Models:

Peugeot: 108, 208, 2008, 301, 308, 3008, 5008
Citroën: C3111, DS3, DS3 Convertible, C-Elysée
Engines: 1.0, 1.2i

Codes OEM :

0109-2A , 0109-2B , 0197-N

COMPATIBLE ENGINE CODES

ZMZ	ZM01	EBO	HMZ	HMT	HMY	HM01	HM02
HNY	HNZ	HN01	HN02	EB2	EB2F	EB2DT	EB2DTS

Also available: our PSA 1.2 12V Turbo 3 cylinder PureTech timing kit does not require the removal of the cylinder head cover.



OM 4058

STRETCH BELT INSTALLATION AND REMOVAL TOOL PSA

Accessory for OM 4051

Specially designed for installing water pump belts on 3-cylinder PSA engines.



Models:

Peugeot: 108, 208, 301, 308, 408, 2008, 3008, 5008, Partner
 Citroën: C1, C3, C3 Picasso, C3 Aircross, C4, C4 Picasso, C4 Cactus, C-Elysée, Berlingo, DS3, DS4, DS4 S, DS5 LS
 Opel: CrosslandX

Engines: PureTech 1.0, 1.2L from 2012.

Codes OEM :
 EN-52112-2



OM 4141

BELT GAUGE PSA 1.0/1.2 PURETECH

Spare part for OM 4041/OM 4058

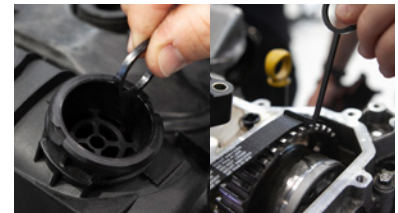

Peugeot : 2008, 208, 308, 5008, 3008
 Courroie : A94F , T9 , P87E , P84E , K9

Codes OEM :
 G-0109-6

COMPATIBLE ENGINE CODES

A94F	T9	P87E	P84E	K9
------	----	------	------	----



OM 4142

CRANKSHAFT SEAL ASSEMBLY TOOL 1.0-1.2 PURETECH

Accessory for OM 3747/OM 4041/OM 3797

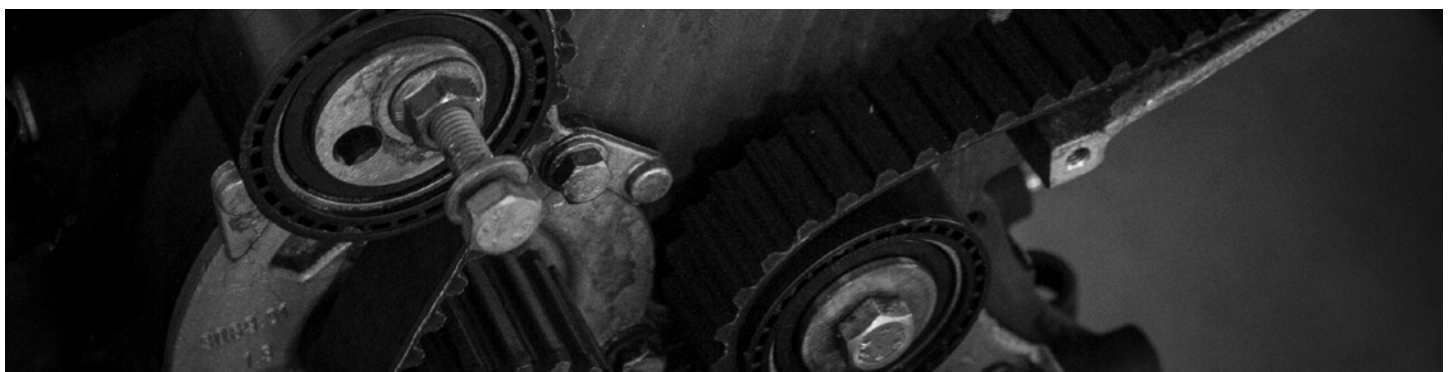

CLAS[®]

GARAGE SOLUTIONS

83 chemin de la Crouza
73800 Chignin - France

contact@clas.com
clas.com



BRAND OF **NTN CORPORATION**

1 rue des Usines
74010 Annecy - France

contact@ntn-snr.com
ntn-snr.com