



Brand of **NTN corporation**

SmartTEMP™

User manual

S - M - L - XL Pivot - XXL - XXXL

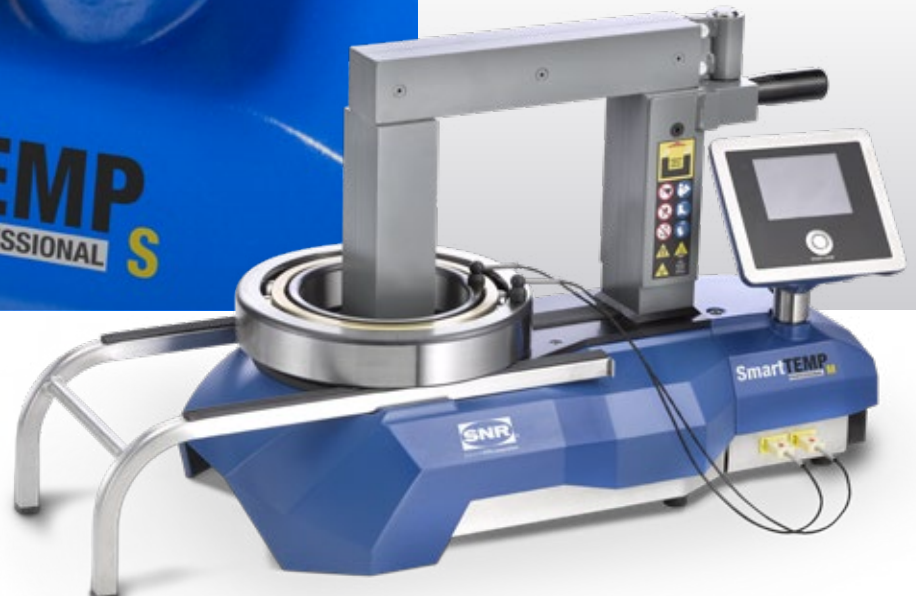

Experts
& Tools



Check delivery for possible damage caused by transport without delay. Should damage be detected, please inform carriers immediately. As our products are subject to continuous improvement, we reserve the right to make changes.

During unboxing, check if parts are missing (see chapter INSTALLATION - Scope of delivery). If so, please contact your local distributor.

CONTENTS

Induction heating	5
Operating conditions _____	5
Safety guidelines	6
Safety precautions _____	6
Safety instructions _____	7
Safety features _____	8
Installation	9
Scope of delivery _____	9
Unboxing _____	9
Installation process _____	10

Setting up the workpiece	11
Choosing the yoke _____	11
Positioning the magnetic temperature probe(S)	12
Operation	13
Temperature Mode, one sensor _____	14
RAMP Mode _____	15
Temperature Mode, two sensors _____	16
Time Mode _____	17
User menu _____	18
Maintenance	19
Malfunction	20
Adjusting the yoke _____	20
Errors _____	21
Specifications	22
Dimensions _____	24
Workpiece dimensions _____	25
Technical data _____	26
Further information _____	28
Electrical drawing _____	29
Declaration of conformity	34





Induction heating

SmartTEMP™ induction heaters are used to heat rolling bearings. Other metal components forming a closed circuit such as bushings, shrink rings, pulleys and gears can also be heated. This will facilitate mounting where an interference fit is required.

Our range of standard heaters are designed to heat the workpiece to a maximum temperature of 240°C (464°F). The heaters can be used on a continuous basis. Always place the temperature sensor on the workpiece to check the heating cycle. When heating an object using Time Mode, the heating cycle must be checked using an external temperature meter.

Operating conditions

The heater is designed to be used in an industrial environment with an ambient temperature of 0°C to 40°C (32°F to 104°F) and an atmospheric humidity between 5% and 90%, non-condensing. The induction heater is intended for indoor use only.

CAUTION!

Bearings generally should only be heated to a maximum temperature of 110°C (230°F). Do not use induction heaters for bearings or workpieces with dimensions outside the ranges specified in this manual. Do not switch off the heater with the main switch while heating cycle is running

Safety guidelines

The operating instructions should always be followed when using an induction heater.

NTN-SNR Roulements shall not be held liable for damages caused by improper handling or by use which does not comply with the designated purpose. Prerequisites for the operator: He/she must be authorised for use of the heater and must be familiar with the safety precautions.

In order to prevent danger or damage to the induction heater or workpiece, follow these guidelines:

- ▶ All repairs must be carried out by an official repair center
- ▶ Use original spare parts only
- ▶ Protect the heater from water or very high humidity during storage
- ▶ Protect the heater core and yokes against corrosion, damage and deformation
- ▶ Only preheat bearings to max. 110°C (230°F)
- ▶ To ensure proper operation of the device, it is important to provide the device with the latest software updates. A description can be found in chapter "**OPERATION - USER MENU**"

Safety precautions

- Since a magnetic field^{4&5} is generated by the induction heater, people wearing a pacemaker¹ or other implant device² should not work or be in the immediate vicinity of the device. Other sensitive equipment such as wrist watches, magnetic carriers, electronic circuits, etc.³ might also be affected. The safety distance is 1 metre (38")
- Use safety gloves as protection against burns to hands. The gloves⁷ delivered are suitable for use up to temperatures of 240°C (464°F) (resistant to contact heat only)
- Hot surface, avoid contact⁶
- Do not operate an induction heater in areas where there is risk of explosion
- Wear safety shoes⁸



Safety instructions

- The user should have an appreciation of the contents of this user manual, and be familiar with safe workshop practices
- Follow the user manual at all times
- Ensure that the induction heater operates at the correct supply voltage. If the heater is not supplied with a plug, changes should only be made by a suitably qualified electrician
- Do not use or store the heater in humid environments. The heater is designed for indoor use only
- Use proper handling equipment, appropriate for the weight of the workpiece and/or yoke. Never support components with a metal cable or have any hanging in the proximity of the magnetic field. Extremely high currents can flow through the cable causing it to heat up quickly, resulting in a risk of burning.
- Do not place any metal objects near the yokes and poles
- Place heater on a stable, horizontal surface
- Keep a minimum distance of 1 metre (38") to surrounding objects
- Use only in well ventilated areas
- Do not heat objects containing oil, grease or similar substances. Prevent possible generation of fumes and smoke
- Do not inhale fumes or smoke from heated parts
- Do not move or lift heater when warm after heating cycle
- Do not touch the heater core during heating cycle

When using the smallest yokes on a SmartTEMP™ XL, XL Pivot, XXL or XXXL, make sure to reduce the maximum power output. An overview of the maximum power output per yoke size can be found on page 12.

Safety features

Should an error occur during the heating process, the induction heater will automatically stop. The corresponding error will be displayed on screen. In the case of user error, the display indicates what steps are to be taken to correct the problem. More information about the types of errors can be found in chapter **"ERRORS"**.

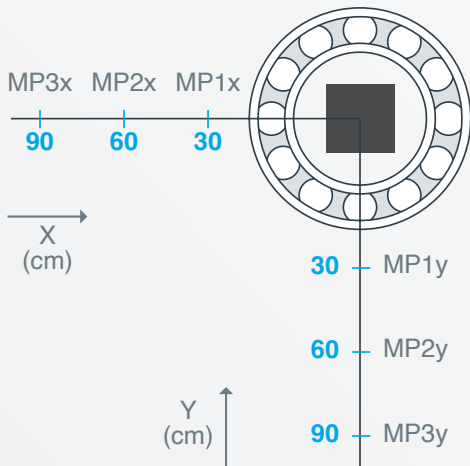

An induction heater produces an electromagnetic field within a coil to transfer energy to a workpiece. The table below shows values of the flux density in microTesla (μT).

These measurements can be used as a guide conforming to local regulations regarding the maximum time exposure to magnetic fields. Different configurations may give different values. It is impossible to provide values for all combinations as the variety of bearing types in combination with the different yokes is large.

SmartTEMP™	S	M	L	XL	XXL	XXXL
Measurement position (cm)	B-field _{total} (μT)					
MP1x	81	249	283	454	864	868
MP2x	16	34	74	189	272	370
MP3x	1	11	28	51	143	201
MP1y	156	181	185	458	874	983
MP2y	27	24	78	191	314	416
MP3y	9	9	41	80	156	196

Total 50Hz RMS field for magnetic measurement results. Max. magnetic flux in safe exposure area, according to the German BG 11 Regulations is $423 \mu\text{T}$.

Installation

Scope of delivery

- 1 **SmartTEMP™ S/M/L/XL/XL Pivot/XXL/XXXL**
- 2 **Yoke(s)** (different according to the model)
- 3 **Temperature probe** (the second probe is optional according to the model)
- 4 **Heat-resistant gloves**
- 5 **User manual**
- 6 **Quickstart guide**



Note

The **SmartTEMP™ S** comes with yokes 20, 35 and 60 included. For the rest of the range, only one yoke is included. **SmartTEMP™ L, XL, XL Pivot, XXL, XXXL** are delivered with two magnetic temperature probes included. The heat-resistant gloves may differ from the picture above.

Unboxing

Follow the specific instructions for the heater on the supplied Quickstart guide. If the Quickstart guide is not included in this box, please contact your distributor.

Note

Check delivery for possible damage caused by transport without delay. Should damage be detected, please inform carriers immediately. As our products are subject to continuous improvement, we reserve the right to make changes.

Installation process

Ensure that supply voltage and current meet the specifications. These can be found on the type plate at the back of the induction heater.

Not all of our induction heaters are provided with a plug, mainly because there are a large number of plug types. A suitable plug must be affixed by a qualified electrician. Voltage may differ for customized heaters.



Electrical connection for SmartTEMP™ S, M, L. The plug is provided for these induction heaters.



Electrical connection for SmartTEMP™ XL, XL Pivot, XXL, XXXL.



Voltage	Phase	Neutral	Ground
110-230 V	Brown	Blue	Green/Yellow



Voltage	Phase X / L1	Phase Y / L2	Ground
400-440 V	Brown	Black	Green/Yellow
460-575 V	Brown	Black	Green/Yellow



Voltage	Phase	Neutral	Ground
400-440 V	Brown	Black	Green/Yellow
460-575 V	Brown	Black	Green/Yellow



Insert the plug into a shockproof wall socket and then connect the heater to mains electricity.

Turn main switch from 0 to 1. The heater will emit a short beep and the touchscreen displays the main menu. The induction heater is now ready for use.

Setting up the workpiece

The workpiece can be set up in two different ways and must never touch the housing. Small objects are to be heated in a vertical position.

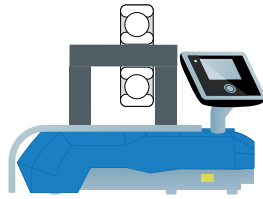

vertical

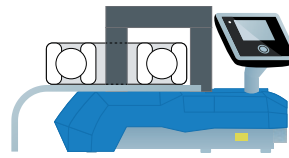

horizontal

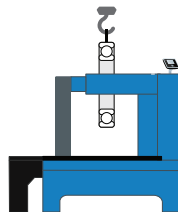
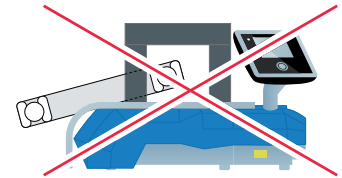

vertical

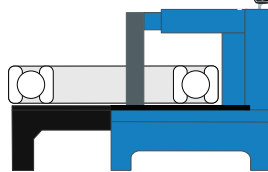

horizontal

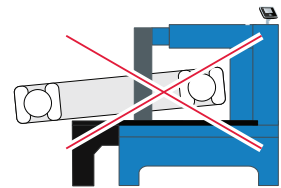
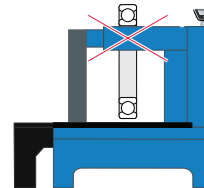

- Use appropriate hoisting equipment for heavy components and yokes. Manual lifting of heavy objects is a common cause of injury
- Wear safety shoes during these procedures
- The weight of the work-piece should not exceed the maximum weight as shown in chapter "**WORKPIECE DIMENSIONS**". Exceeding these limits may result in catastrophic equipment failure and may also lead to personal injury
- Ensure there is no contact between the mains cable and the workpiece. Damage to the cable may result in electrocution
- Never support components with a metal cable and avoid metal cables hanging in the proximity of the magnetic field. Extremely high currents can flow through the cable causing it to heat quickly, resulting in risk of burning

Choosing the yoke

- Choose largest possible yoke which fits the diameter of the workpiece. Position the workpiece onto the yoke and place the yoke with the machine milled surface on the poles of the heater core
- Always make sure that the workpiece avoids direct contact with the housing of the heater

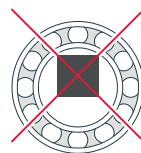
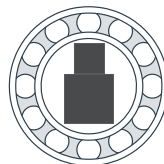
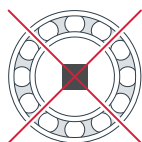
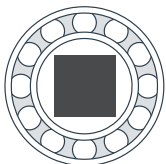

- When a heating cycle is completed, always wear heat-resistant gloves. The maximum temperature of the workpiece on a standard induction heater is 240°C (464°F)
- Always treat yokes carefully. Falling, bumping, etc. can damage the yoke and/or cause personal injury
Always store the yoke safely immediately after use

When using Ramp Mode or Temperature Mode with two sensors, the actual effective power will constantly change during the heating cycle. This is done automatically. When using Time Mode or Temperature Mode with one sensor, the standard effective power is 100%. Turning the power down is needed when:

- ▶ Applying smaller yokes, especially during continuous use.

To prevent the hardware from overheating, make sure to reduce the maximum power output according to the table.

YOKES	XL	XXL	XXXL
20 x 20	40%	N/A	N/A
30 x 26	50%	40%	N/A
40 x 38	60%	40%	N/A
50 x 48	80%	50%	N/A
60 x 60	100%	50%	50%
70 x 70	100%	50%	N/A
80 x 80	100%	60%	60%
90 x 90	N/A	80%	N/A
100 x 100	N/A	100%	80%
150 x 150	N/A	N/A	100%

Positioning the magnetic temperature probe(S)

- ▶ Always use the magnetic temperature probe (hereafter referred to as the 'probe') for heating in Temperature Mode or Ramp Mode.
- ▶ Place the probe on the workpiece, close to the bore. Make sure that the surface used for the probe is free of grease and/or oil.
- ▶ If the induction heater has two probes: place one close to the bore and the other on the outer ring.

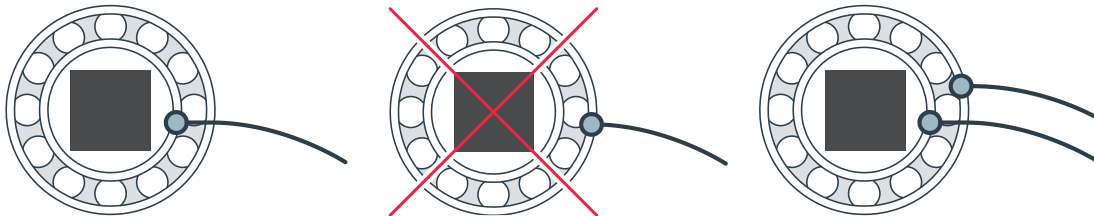

- ▶ Our standard probes are suitable for operation up to a maximum temperature of 240°C (464°F). The connection between magnet and probe will break above the maximum temperature. If this occurs when operating in Temperature Mode, the heater will turn itself off as the probe will fail to register any increase in the temperature over a set period of time. Probes for higher temperatures are optional.
- ▶ Connect the probe by inserting the plug into the socket at the front of the heater, with the red dot facing upwards.



CAUTION

Treat the probe with care. It is a valuable part of the heater and can easily be damaged through careless handling. After use, we suggest that it be placed on the side of the vertical pole.

Operation

When the induction heater is turned on, the homescreen can show up to four buttons with different modes; Time Mode is always available. Temperature Mode (with 1 sensor) and Ramp Mode will be enabled when one sensor is inserted. An extra Temperature Mode (with 2 sensors) will be enabled when a second sensor is inserted.

The start/stop button is used for starting heating cycles in one of the modes, or to stop a heating cycle at any time.



Every mode has three stages:

1. **Preparation** - The user can change the temperature and/or time.
2. **Heating process** - The induction heater starts the heating cycle.
3. **Completion** - The heating cycle has ended.

When a heating cycle is complete, or stopped prematurely, the program will return to the main screen of the heating mode. A graph can be requested with the graph button .



Temperature Mode, one sensor

1. PREPARATION

To change the temperature, press **110°C**.

Otherwise, proceed to step 2.

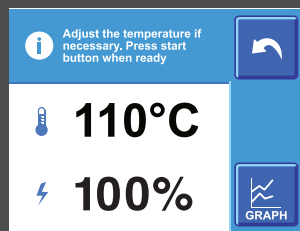

Press **+** or **-** to change the temperature (max. 240°C).

Press **✓** when the temperature is set.

2. HEATING PROCESS

Press **○** to start the heating cycle and stand at a safe distance.

There is a 5 second countdown before the cycle starts.

When the preset temperature has been reached, the heater will hold that temperature.

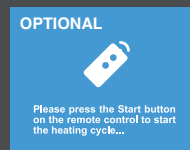
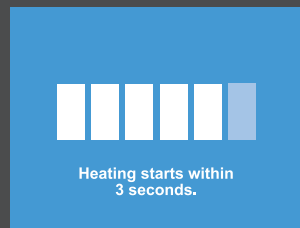

Alternatively, to start the heating process, press the start button on the remote.

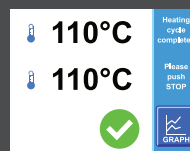

3. COMPLETION

Press **○** to stop the heating cycle.

The induction heater will now demagnetize.

After it will return to the first screen.

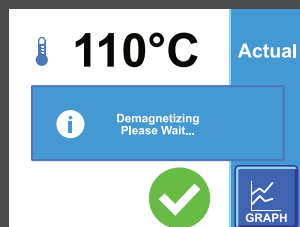



RAMP Mode

1. PREPARATION

To change the temperature, press **110°C**.

To change the heating time, press **0:00**.

Otherwise, proceed to step 2.

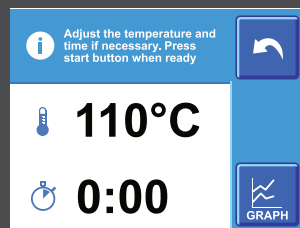

Press **+** or **-** to change the temperature (max. 240°C).

Press **✓** when the temperature is set.

Press **+** or **-** to change the time.

Press **✓** when the time is set.

2. HEATING PROCESS

Press **○** to start the heating cycle and stand at a safe distance.

There is a 5 second countdown before the cycle starts.

When the preset temperature has been reached, the heater will hold that temperature.

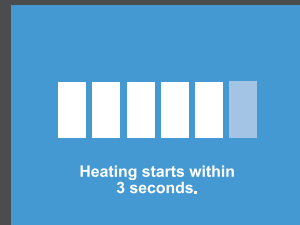

Alternatively, to start the heating process, press the start button on the remote.

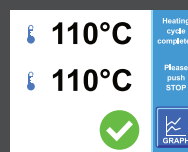

3. COMPLETION

Press **○** to stop the heating cycle.

The induction heater will now demagnetize.

After it will return to the first screen.

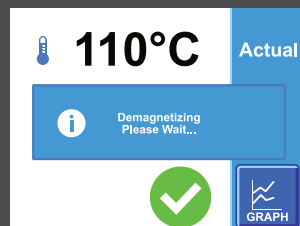



Temperature Mode, two sensors

1. PREPARATION

To change the temperature, press **110°C**.

To change the Δ temperature, press **35°C**. Otherwise, proceed to step 2.

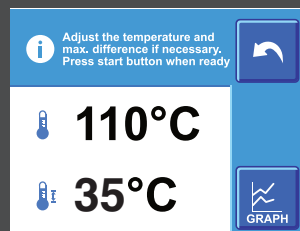

Press **+** or **-** to change the temperature (max. 240°C).

Press **✓** when the temperature is set.

Press **+** or **-** to change the Δ temperature (min. 20°C).

Press **✓** when the temperature is set.

2. HEATING PROCESS

Press **○** to start the heating cycle and stand at a safe distance.

There is a 5 second countdown before the cycle starts.

When the preset temperature has been reached, the heater will hold that temperature.

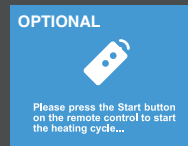
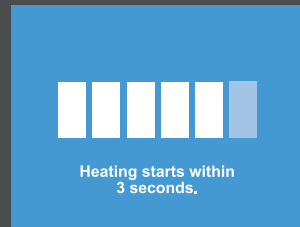

Alternatively, to start the heating process, press the start button on the remote.

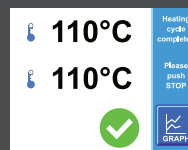
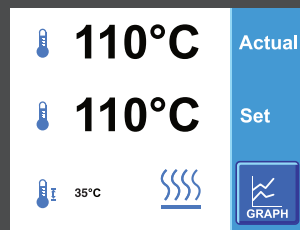

3. COMPLETION

Press **○** to stop the heating cycle.

The induction heater will now demagnetize.

After it will return to the first screen.

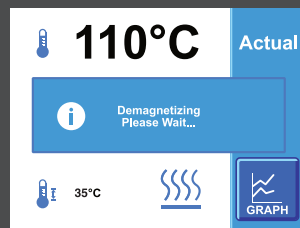



Time Mode

1. PREPARATION

To change the heating time, press **0:00**. Otherwise, proceed to step 2.

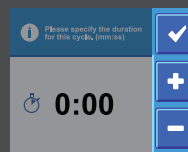
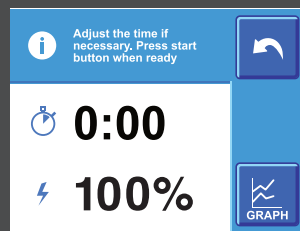

Press or to change the time ().

Press when the time is set.

2. HEATING PROCESS

Press to start the heating cycle and stand at a safe distance.

There is a 5 second countdown before the cycle starts.

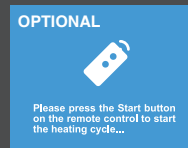
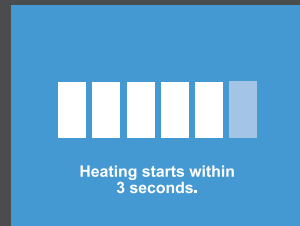

Alternatively, to start the heating process, press the start button on the remote.

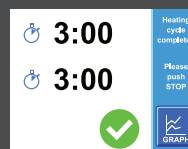
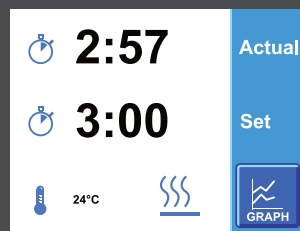

3. COMPLETION

Press to stop the heating cycle.

The induction heater will now demagnetize.

After it will return to the first screen.

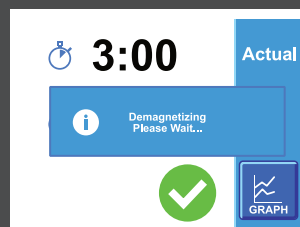

User menu

The user menu can be accessed by pressing the start/stop button for 8 seconds. Within this menu, the user can view and/or change the following settings:

U0 Reset to Factory Settings

Each user setting will be reset to its original factory values.

U1 Languages

The languages of the heater can be changed to English, Spanish, German, and French, Italian, Japanese, Russian.

U2 Default Temperature (110°C)

The default temperature can be set. The factory set temperature is 110°C (230°F).

U3 Temp. Hold (On)

Temperature hold can be turned on or off. During pendulation the heater will heat to the set temperature and cools down by 3°C, then heats again to the set temperature, etc.

U4 Temp. Hold Duration (5:00)

The duration of the temperature hold can be set. With the factory set duration of 5:00 min the heater pendulates indefinitely.

U5 Completion Signal (On)

The buzzer can be turned on or off. When on the heater will buzz when it reaches the set temperature. The factory set value is 'on'.

U6 Temperature Unit (°C)

The temperature unit can be changed to Celsius or Fahrenheit. The factory set temperature unit is Celsius, Fahrenheit in the USA.

U7 Maximum Temp. Delta (35°C)

The max. temperature difference between the two sensors can be set. The factory set temperature difference is 35°C (122°F).

U8 Remote Control (Optional)

The remote control function can be turned on or off. This setting is shown only when the remote has been included.

U9 Calibration Sensor 1

The temperature of sensor 1 can be set if it is calibrated incorrectly.

U10 Calibration Sensor 2

The temperature of sensor 2 can be set if it is calibrated incorrectly.

U12 Start Delay (5)

A delay can be set for the start of the heating process. When the user starts the heating process there will be a delay so to enable removal to a safe distance. The factory set delay is 5 seconds.

U13 Date Format (DD/MM)

The Date Format can be set to Day/Month or Month/Day.

U14 Screensaver (Off)

The settings for the screen saver can be set here, ranging from off to a certain number of seconds.

U15 Time (0:00)

The current time can be set here. This information will be used when datalogging the heating cycle.

U16 Date (0/0)

The current date can be set here. This information will be used when datalogging the heating cycle.

U17 Year (2000)

The current year can be set here. This information will be used when datalogging the heating cycle.

U18 Time Format (24:00)

The Time format can be set to 24:00 or AM/PM.

U19 Temp. Hold Hysteresis (3°C)

The max. temperature difference before the heater starts heating again can be set here.

U20 Auto Sensor Select (On)

When this setting is turned on the heater can recognize the difference between Sensor 1 and Sensor 2 and assign the order automatically.

U22 Time Range (MM:SS)

The Time Range can be switched between MM:SS (minutes and seconds) and HH:MM (hours and minutes). This Time Range setting will be applied to the available range when using Time Mode.

U24 Exit (Discard Changes)

Any recent adjustments will be discarded and the user returns to the homescreen.

U26 Update Firmware GUI

When a USB drive (containing an update for the User Interface) is inserted this option will show. Press and follow the on-screen instructions to update the heater.

U27 Update Firmware PWR

When a USB drive (containing an update for the Powerboard) is inserted this option will show. Press and follow the on-screen instructions to update the heater.

U28 Update Languages

When a USB drive (containing an update for texts) is inserted this option will show. Press and follow the on-screen instructions to update the Fonts and Texts.

U29 Cur. Version GUI

The current version of the User Interface is shown here.

U30 Cur. Version PWR

The current version of the Powerboard is shown here.

U31 Number of Cycles

The Number of Cycles shows the amount of heating cycles for the induction heater.

U32 Heating Timer

The Service Counter shows the total time (all heating cycles added together) for the induction heater.

Maintenance

- ▶ Store in a dry, frost-proof area, free from humidity.
- ▶ Keep clean with a soft, dry cloth.
- ▶ Keep the display clean for optimal responsiveness and to avoid any scratches.
- ▶ Keep the contact parts of the heater core poles greased. Grease regularly with an acid-free grease for optimal contact and to avoid corrosion (in the case of heaters with a pivoting yoke, also grease the vertical pin regularly).
- ▶ CRITICAL SPARE PART - Magnetic probe. Always use original spare parts, we cannot guarantee a proper functioning using other parts.

CAUTION

Proper maintenance and handling practices are critical. Failure to follow installation and maintenance instructions can result in equipment failure, creating a risk of serious bodily harm.

Malfunction

If a loud vibrating noise is heard:

- ▶ Stop the heating cycle by pressing the start/stop button.
- ▶ Are the contact surfaces clean and greased sufficiently?
- ▶ Are the yokes 100% in contact with the surface? If this is not the case adjust the yoke with instructions below.

Adjusting the yoke

1. Check if the machine milled surface is smooth.
2. Place yoke or pivoting yoke on the heater.
3. Unscrew the screws in the yoke and pivoting point a quarter turn.
4. Turn on the heater and the yoke will set itself or use a nylon hammer.

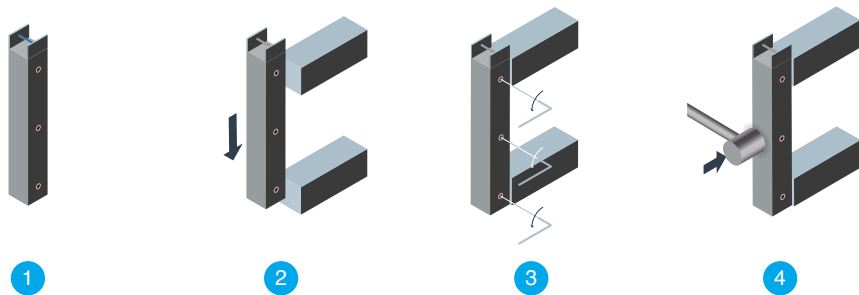
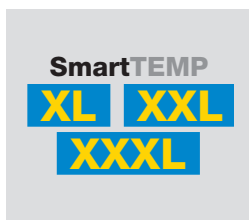
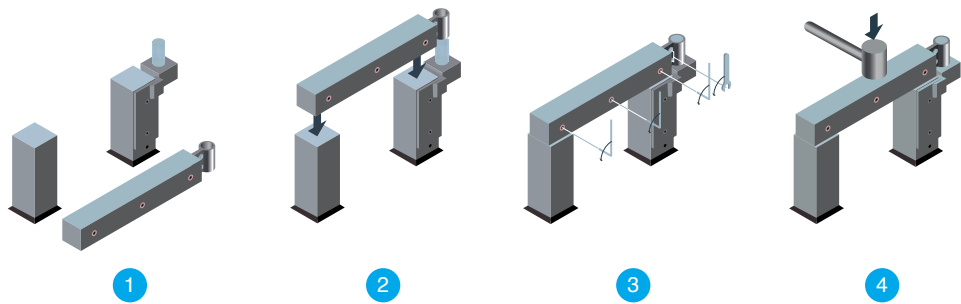
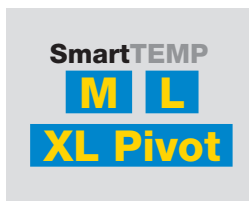

5. Fasten screws, turn off heater and the yokes are now adjusted.

CAUTION

If in any doubt, isolate the induction heater and contact your local distributor.

Errors

The induction heater can display two different kinds of errors: User errors (indicated by blue background) and Fatal errors (indicated by red background). The type of error message determines the difficulty of the action needed to make the induction heater function properly.

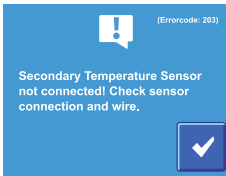

Most of the User errors are easy to solve, as the user interface will provide a suggestion for troubleshooting. The user should always end the troubleshooting by restarting the heater. If the error persists after troubleshooting the user can contact the local distributor.

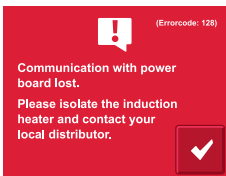

Fatal errors cannot be resolved without contacting the local distributor, as the problem is caused by an internal hardware or software error. When encountering a Fatal error the user must note the Error-code (found in the top righthand corner) and the operating conditions. Operating conditions may contain a description of the part that has been heated, the heating mode that has been used, and any other relevant information.

Specifications

SmartTEMP™ **S**

Base dimensions: 450 x 210 x 275 mm



SmartTEMP™ **M**

Base dimensions: 540 x 275 x 365 mm
Pivoting yoke



SmartTEMP™ **L**

Base dimensions: 695 x 330 x 435 mm
Pivoting yoke



SmartTEMP™ XL XL Pivot

Base dimensions: 850 x 410 x 1050 mm



SmartTEMP™ XXL

Base dimensions: 1080 x 500 x 1350 mm



SmartTEMP™ XXXL

Base dimensions: 1500 x 800 x 1600 mm



Dimensions

SmartTEMP™ has an adjustable rack which gives it a larger surface area to hold larger workpieces. The heater core itself is non-adjustable. With a set of extension yokes the height can be extended.

SmartTEMP™ S

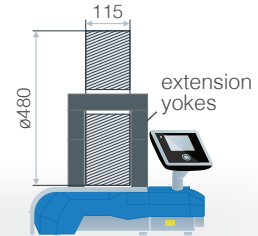
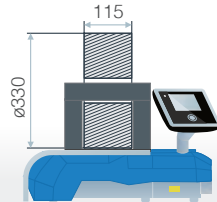
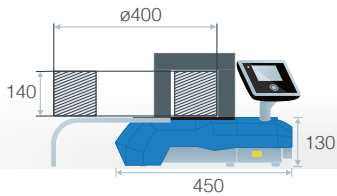

SmartTEMP™ M

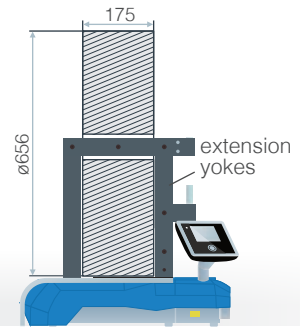
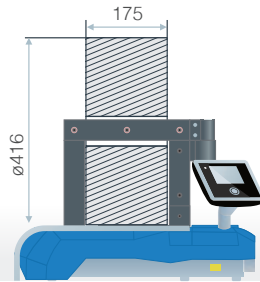
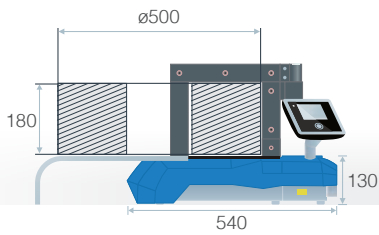

SmartTEMP™ L

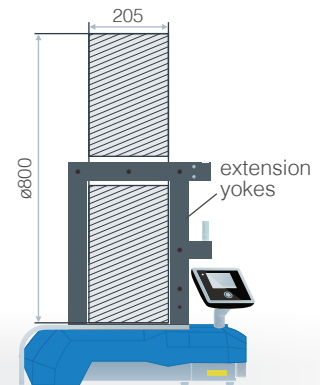
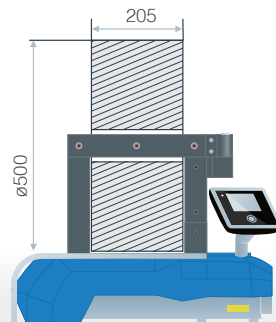
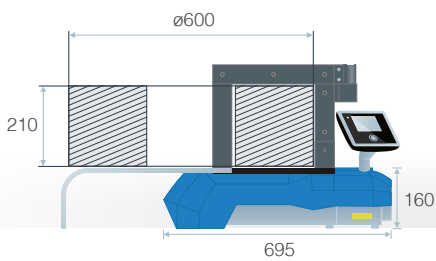

Workpiece dimensions shown here are extremes and depend on the yoke size used. See the table on the next page for an extensive overview.

Workpiece dimensions

Horizontal (in millimeters)

SmartTEMP™	S	M	L	
Min. bore	ø 66	ø 80	ø 108	
Max. outer diameter	ø 400	ø 500	ø 600	
Max. width	140	180	210	
Max. width incl. ext. yokes	215	300	360	

Vertical (in millimeters)

SmartTEMP™	S	M	L	
Max. outer diameter	ø 330	ø 416	ø 500	
Max. width	115	175	205	
Max. outer diameter incl. ext. yokes	ø 480	ø 656	ø 800	

Horizontal (in millimeters)

SmartTEMP™	XL	XL Pivot	XXL	XXXL
Min. bore	ø 30	ø 125	ø 40	ø 85
Max. outer diameter	ø 1000	ø 1000	ø 1500	ø 2000
Max. width	315	290	485	695
Max. width incl. ext. yokes	n/a	490	n/a	n/a

Vertical (in millimeters)

SmartTEMP™	XL	XL Pivot	XXL	XXXL
Min. bore	ø 150	ø 30	ø 300	ø 400
Max. outer diameter	ø 728	ø 680	ø 1140	ø 1640
Max. width	290	320	425	675
Max. outer diameter incl. ext. yokes	n/a	ø 1080	n/a	n/a

The dimensions shown above are theoretical. In practice there are multiple factors (e.g. workpiece weight, material and placement) that influence the possibility and/or the time needed to heat the workpiece properly.

Technical data

SmartTEMP™		S	M	L
Electricity	Power rating	3 kVA	3.7 kVA	8 kVA
	Voltage	110 - 230 V	110 - 230 V	400 - 575 V
	Current max.	13 A	16 A	20 A
	Frequency	50 / 60 Hz	50 / 60 Hz	50 / 60 Hz
Controls for tension-free heatingW	Max. Temp. (1 sensor)	240°C	240°C	240°C
	Max. Temp. (2 sensor)	240°C Δ T 20 - 50°C	240°C Δ T 20 - 50°C	240°C Δ T 20 - 50°C
	Time	0 min - 99 hours	0 min - 99 hours	0 min - 99 hours
	Time / Temp. Ramp	5 min - 99 hours 5 - 240°C	5 min - 99 hours 5 - 240°C	5 min - 99 hours 5 - 240°C
Yokes (mm)	* = Standard P = Pivoting	7x7x200	7x7x280	
		10x10x200	10x10x280	14x14x350
		14x14x200 *	14x14x280	20x20x350 P
		25x24x200 *	25x24x280 P	30x26x350 P
		30x26x200	30x26x280 P	40x38x350 P
		40x38x200 *	40x38x280 P	50x48x350 P
		n/a	50x48x280 P *	60x60x350 P
		n/a	n/a	70x70x350 P *
	Extension yokes (lxwxh)	40x50x75	50x62x120	70x82x150
Weight		21 kg	40 kg	85 kg
Max. weight workpiece		50 kg	100 kg	200 kg

Technical data

SmartTEMP™		XL	XL Pivot	XXL	XXXL	
Electricity	Power rating	12.8 kVA	12.8 kVA	25.2 kVA	40 kVA	
	Voltage	400 - 480 - 575 V	400 - 480 - 575 V	400 - 480 - 575 V	400 - 480 - 575 V	
	Current max.	32 A	32 A	63 A	100 A	
	Frequency	50 / 60 Hz	50 / 60 Hz	50 / 60 Hz	50 / 60 Hz	
Controls for tension-free heating	Max. Temp. (1 sensor)	240°C Optional: 400°C	240°C Optional: 400°C	240°C Optional: 400°C	240°C Optional: 400°C	
	Max. Temp. (2 sensor)	240°C Δ T 20 - 50°C	240°C Δ T 20 - 50°C	240°C Δ T 20 - 50°C	240°C Δ T 20 - 50°C	
	Time	0 min - 99 hours	0 min - 99 hours	0 min - 99 hours	0 min - 99 hours	
	Time / Temp. Ramp	5 min - 99 hours 5 - 240°C	5 min - 99 hours 5 - 240°C	5 min - 99 hours 5 - 240°C	5 min - 99 hours 5 - 240°C	
Yokes (mm)	* = Standard P = Pivoting	20x20x490	20x20x490 P	n/a	n/a	
		30x26x490	30x26x490 P	30x26x750	n/a	
		40x38x490	40x38x490 P	40x38x750	n/a	
		50x48x490	50x48x490 P	50x48x750	n/a	
		60x60x490	60x60x490 P	60x60x750	60x60x1080	
		70x70x490	70x70x490 P	70x70x750	n/a	
		80x80x490 *	80x80x490 P *	80x80x750	80x80x1080	
		n/a	n/a	90x90x750	n/a	
		n/a	n/a	100x100x750 *	100x100x1080	
		n/a	n/a	n/a	150x150x1080 *	
		Extension yokes (lxwxh)	n/a	80x80x150 P 80x80x200 P	n/a	n/a
	Weight		157 kg	157 kg	280 kg	650 kg
Max. weight workpiece		400 kg	400 kg	800 kg	1600 kg	

Further information

Error report	Shown in display
Heating graph	Shown in display
Heating temperature (1 sensor)	Set and actual temperature, time and power
Heating time	Set and actual time
Heating time / temp. ramp	Set and actual temperature, time and power
External interface 1	USB 2.0 Port
External interface 2	Network Connection (on demand)
Sound signal	Buzzer
Demagnetizing	<2A/cm
Magnetic probe	One piece
Temperature hold	Yes
Thermal safety guard coil	Yes
Languages	English, French, German, Spanish, Italian, Japanese, Russian
Warranty	24 months
Extended Warranty	+ 12 months

Electrical drawing

SmartTEMP™ **S** **M**

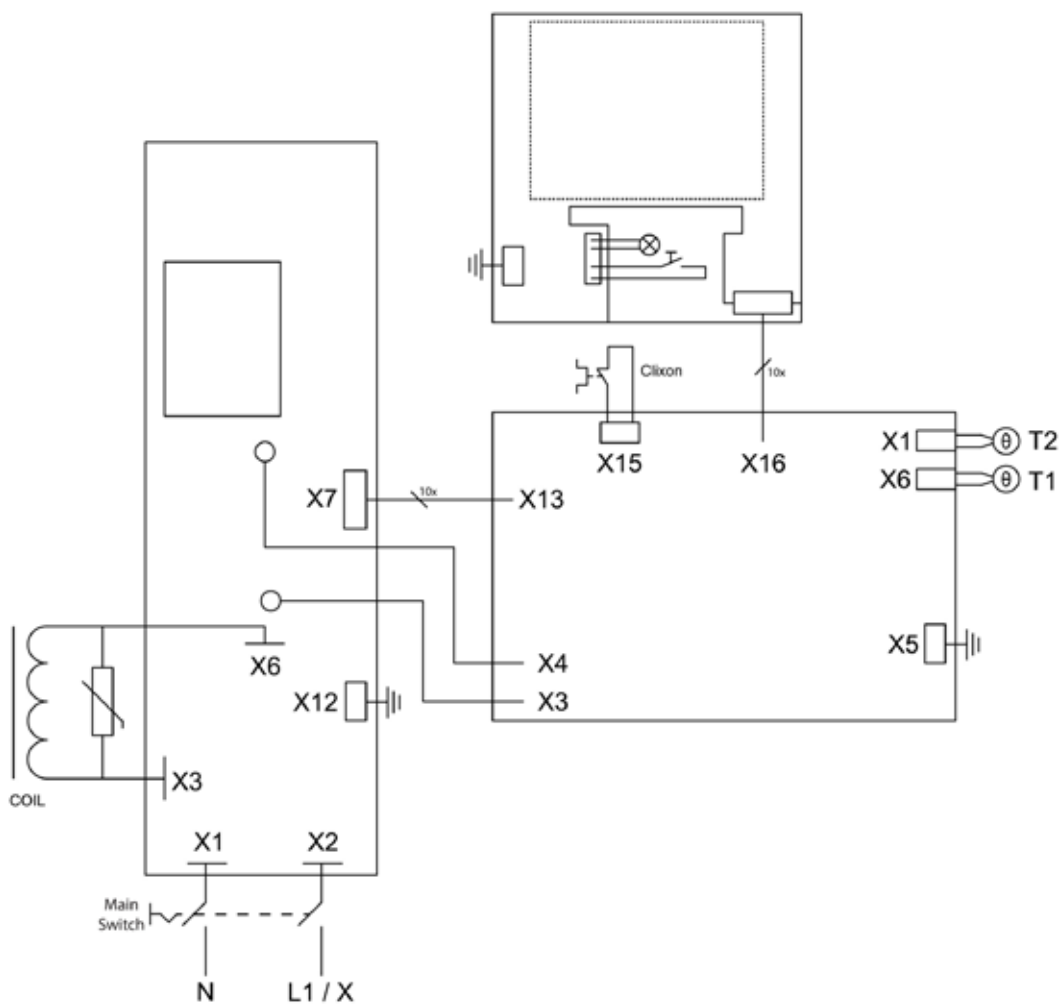

Electrical drawing

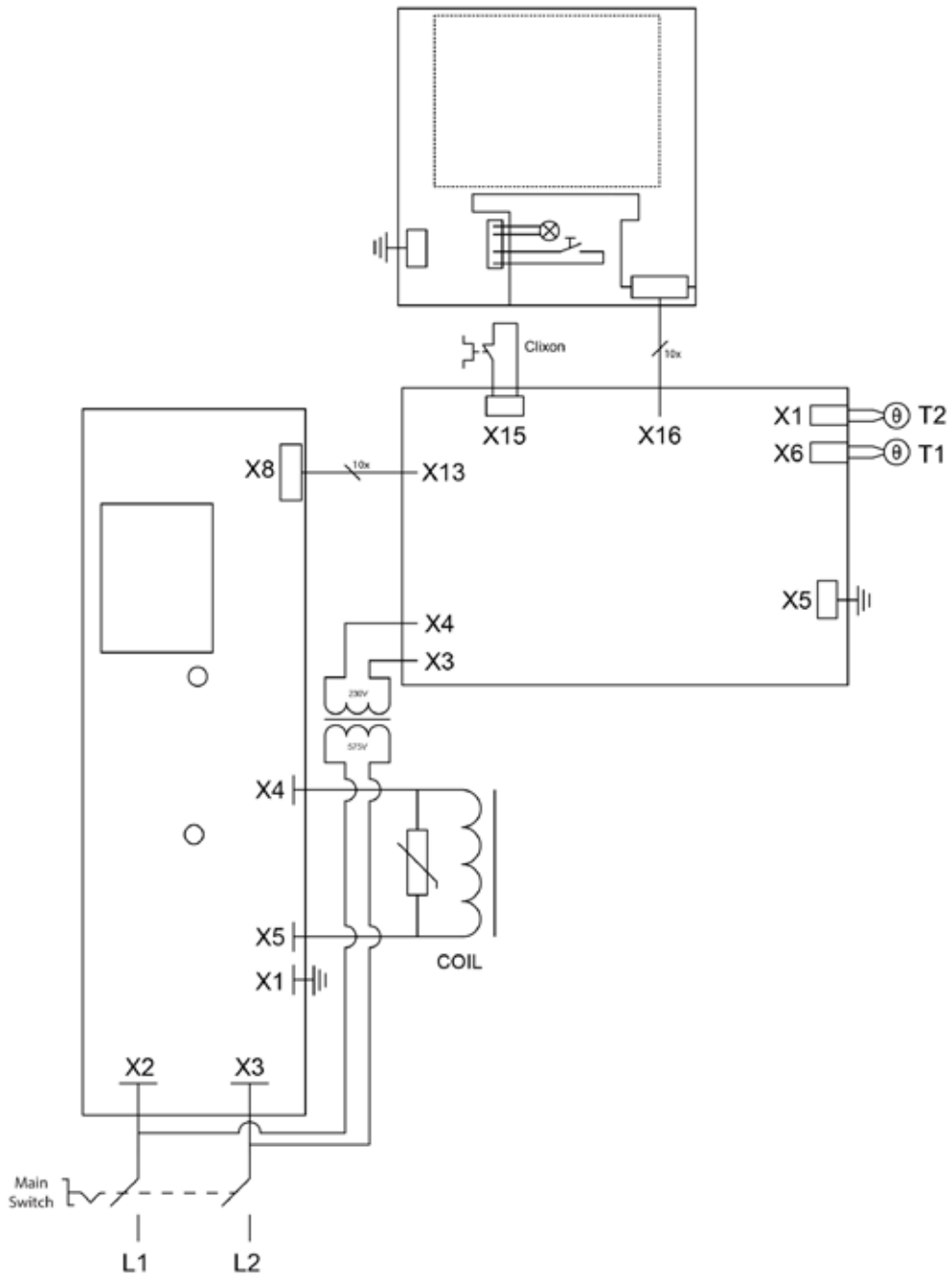

Electrical drawing

SmartTEMP™ XL XL Pivot

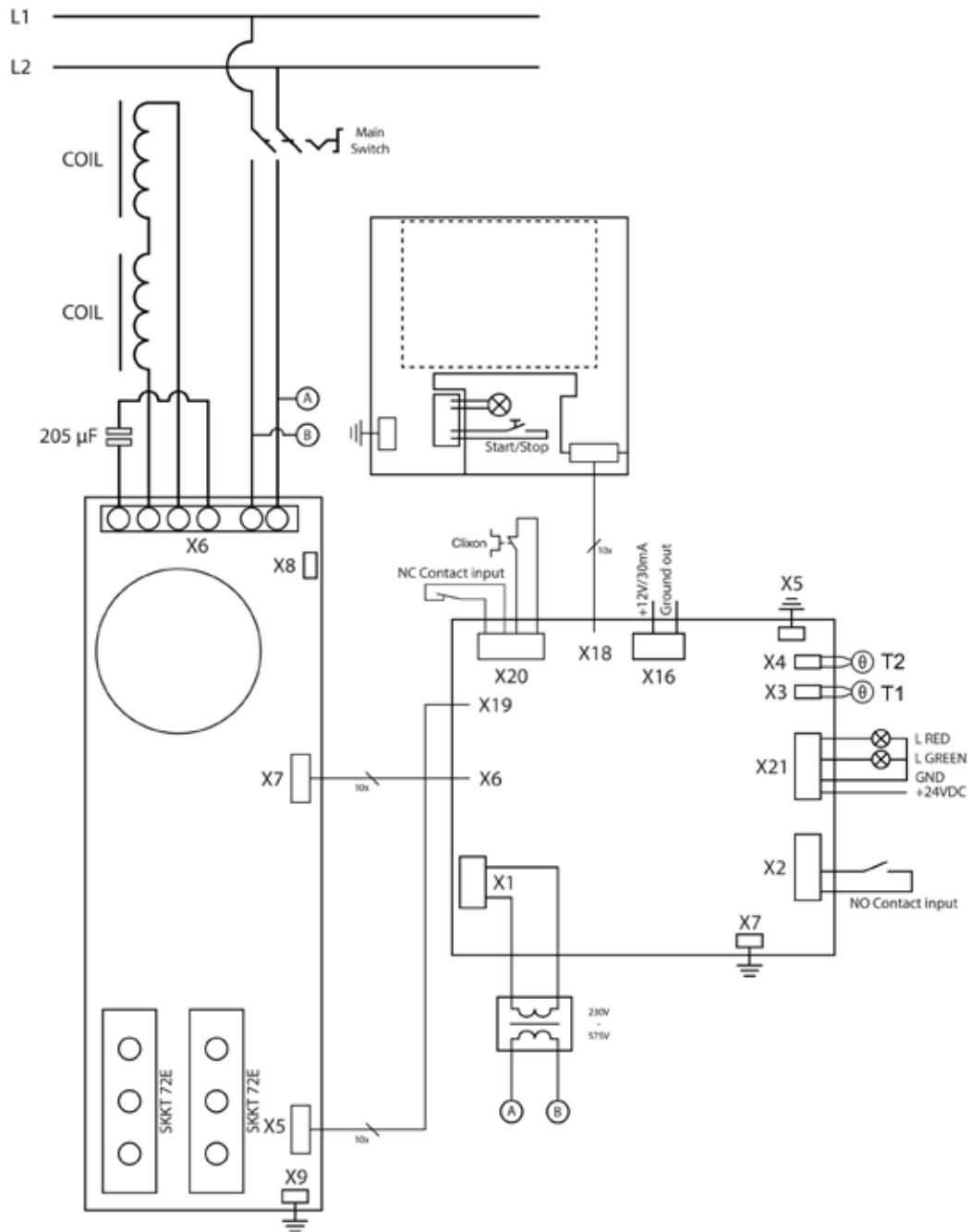

Electrical drawing

SmartTEMP™ **XXL**

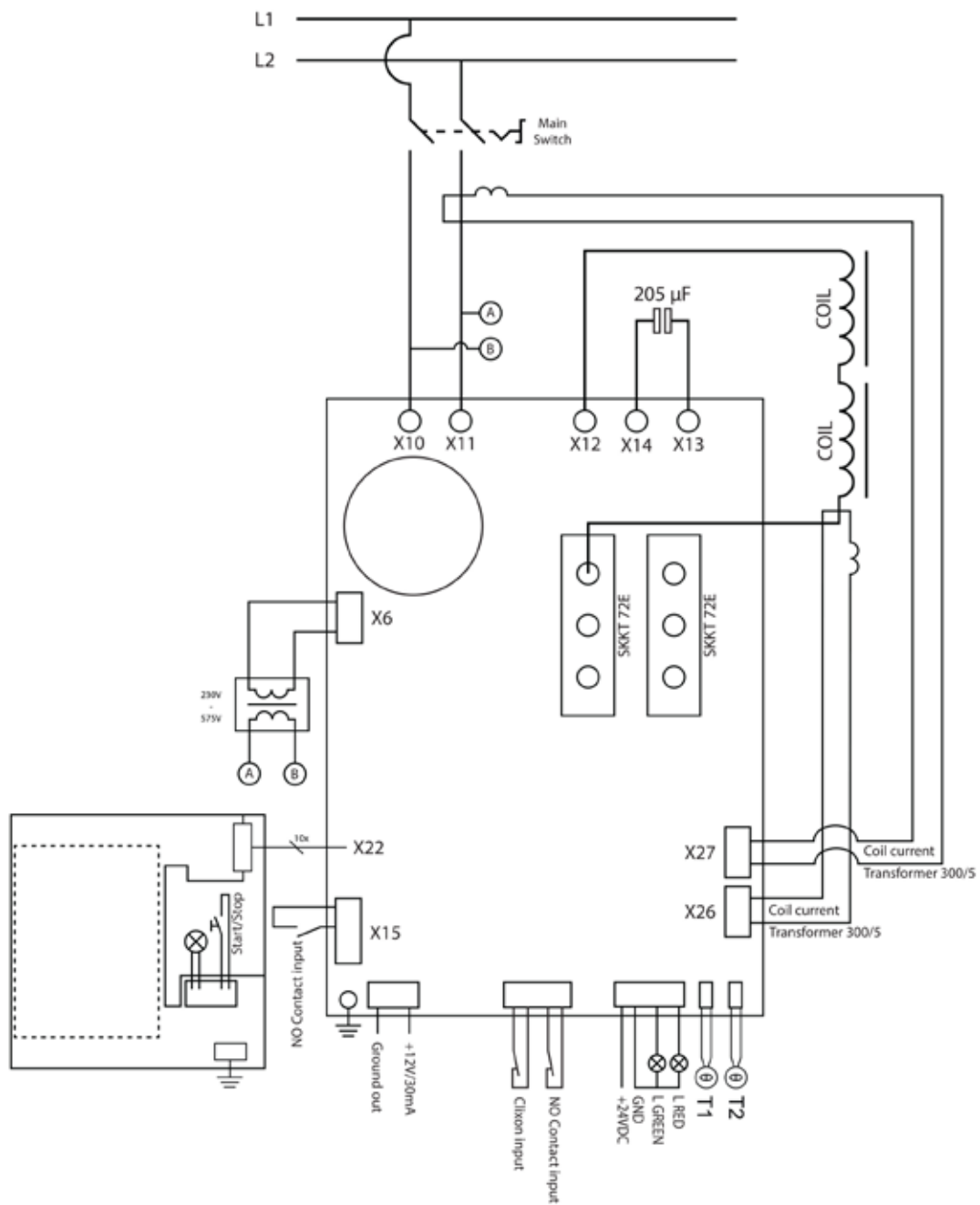

Declaration of conformity

Manufacturer NTN-SNR ROULEMENTS

Address 1 rue des usines
74000 ANNECY
FRANCE

We hereby declare that the supplied version of

Name product SmartTEMP™ S / M / L / XL / XL Pivot / XXL / XXXL

Type product INDUCTION HEATER

This product complies with technical standards specifications as defined by MACHINE DIRECTIVE 2006/42/EC, LOW VOLTAGE DIRECTIVE 2014/35/EU and EMC DIRECTIVE 2014/30/EU.

In conjunction with the following harmonized standards and where appropriate other technical standards and specifications:

Risk Assessment EN-ISO 12100:2010

Design & Manufacture EN-IEC 61000-4-6:2007/A1:2011

EN-IEC 60204-1:2006/C11:2010

NEN 3140/A1:2015

Name Mr. Mathieu OLLIER

Function Sales & Marketing Director Industry Aftermarket

Signature





This document is the exclusive property of NTN-SNR ROULEMENTS. Any total or partial reproduction hereof without the prior consent of NTN-SNR ROULEMENTS is strictly prohibited. Legal action may be brought against anyone breaching the terms of this paragraph. NTN-SNR ROULEMENTS shall not be held liable for any errors or omissions that may have crept into this document despite the care taken in drafting it. Due to our policy of continuous research and development, we reserve the right to make changes without notice to all or part of the products and specifications mentioned in this document.
© NTN-SNR ROULEMENTS, international copyright 2022