

QUARRY PACK
**ALWAYS EFFECTIVE
AND RELIABLE**
in extreme conditions

NTN® **SNR**®

www.ntn-snr.com



With You

SIMPLIFY YOUR ACTIVITY WITH THE NTN-SNR OFFERING:

- SOLUTIONS FOR EVERY STAGE OF THE MANUFACTURING PROCESS.
- ABSOLUTE RELIABILITY TO REDUCE YOUR MAINTENANCE INTERVALS.
- COMPLETE KITS, DESIGNED TO HAVE EVERYTHING ON HAND.

1 GRINDING/CRUSHING

Spherical roller bearings of large size (up to 600 mm) and SNCD ductile cast iron bearings, the turnkey solution for increased impact resistance.



You no longer need to worry about impacts with our range of spherical roller bearings and bearing housings!

2 SCREENING

Spherical roller bearings EF800, a range designed for extreme resistance to vibrations

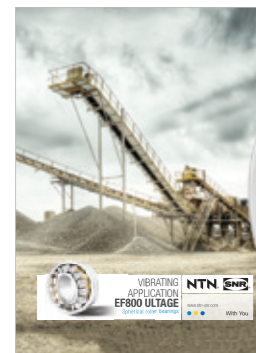

Our EF800 bearings: the perfect solution for vibrating applications.

3 CONVEYING

SNC BEARING HOUSING/ OPEN OR SEALED BEARING KITS:

Order a single product reference and be sure everything is available...

It is simple, everything is in the box!

SEALED BEARING KITS:

Increased service life for conveyors.

Mounting is made easy thanks to our kits including the specific elements of sealed spherical roller bearings.



We have thought of everything to make mounting easier for you!

AGR INSERT BEARINGS:

Premium protection against pollution and lifelong lubrication for reduced maintenance. Adaptable to all self-aligning ball bearing types.



Once you've mounted it, forget about it!



NTN-SNR, a leading player

Expert in Product Life Cycle Management, NTN Corporation is characterised by the closeness and commitment of its teams. We think ahead to development projects in your strategic markets.

Our engineers work with you to design solutions specific to your market. Our NTN and SNR brands contribute to the excellence of your machines and so support their promotion.

LUBRICATION, TOOLS & SERVICES

Providing you with a complete solution of tools and services for your bearings, suited to your application, size and resources.

LUBRICATION RANGE:

Greases: Heavy Duty/VIB.

Single-point lubrication system: Drive Booster.

TOOL RANGE:

A complete range for mounting and removal assistance.

TRAINING:

Training of your employees on the choice and maintenance of bearings.

TECHNICAL ASSISTANCE:

Our Experts & Tools specialists help with maintenance work using our mobile assistance concept, the BeBox.

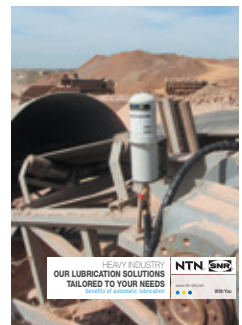



QUARRY PACK

ALWAYS EFFECTIVE AND RELIABLE

in extreme conditions

Distributed by:



This document is the exclusive property of NTN-SNR ROULEMENTS. Any total or partial reproduction hereof without the prior consent of NTN-SNR ROULEMENTS is strictly prohibited. Legal action may be brought against anyone breaching the terms of this paragraph.

NTN-SNR ROULEMENTS shall not be held liable for any errors or omissions that may have crept into this document despite the care taken in drafting it. Due to our policy of continuous research and development, we reserve the right to make changes without notice to all or part of the products and specifications mentioned in this document.

© NTN-SNR ROULEMENTS, international copyright 2017.

NTN-SNR ROULEMENTS - 1 rue des Usines - 74000 Annecy
RCS ANNECY B 325 821 072 - Code APE 2815Z - Code NACE 28.15
www.ntn-snr.com



With You



DOC: L'OUVRAGE - SAP - 389151 - Conception et réalisation : Service publicité NTN-SNR © 04/2017 - Photos: © Pedro Studio Photos - Shutterstock

NTN-SNR SOLUTIONS SEALED BEARING KITS FOR CONVEYORS

QUARRIES, MINES & CEMENT PLANTS



www.ntn-snr.com



With You



SPECIFIC CHARACTERISTICS:

- Longer service life of the bearing
- Reduced maintenance costs
- Reduction of environmental impact
- Interchangeability with standard open bearings



**CREATED TO INCREASE
PRODUCTIVITY,
PERFORMANCE AND
RELIABILITY IN HARSH
ENVIRONMENTS**

OPT FOR THE ALL-IN-ONE

Benefits of kits

- No error in the choice of components
- Simplicity of ordering and storage
(Only 1 reference to manage instead of 3)
- No oversight at the time of mounting
- Mounting kit for fixed and floating bearings (2 in 1)*

* Mounting in standard cast iron bearing housing (SNC NTN-SNR type)

SEALED BEARING KITS FOR CONVEYORS

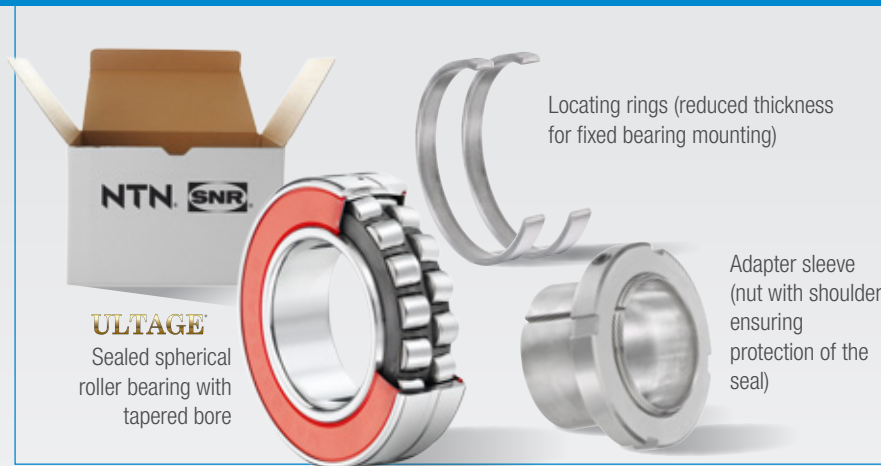

Shaft diameters
from 35 to 90 mm

26 available KIT references:
13 with normal clearance
13 with C3 clearance

On request, possibility of extending the range to other shaft diameters

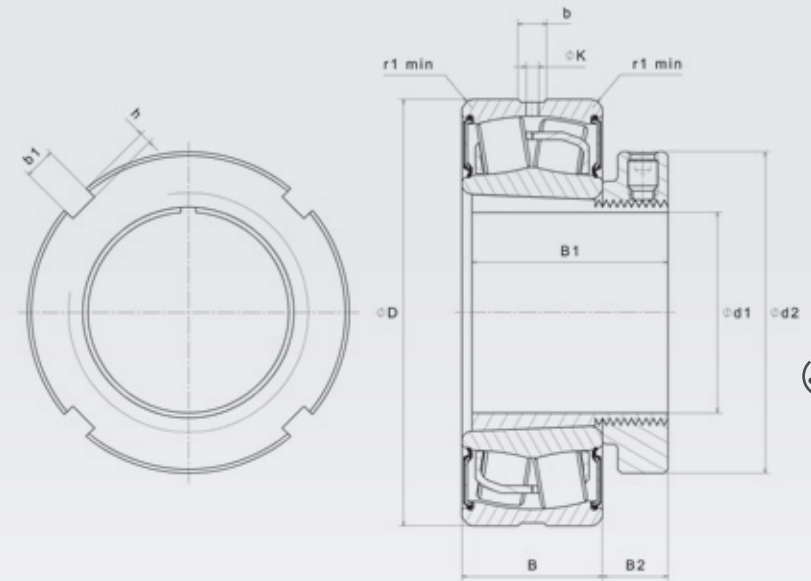

Description	Overall dimensions			Fatigue load limit	Basic capacity		Calculation factors				Limit speed	Weight	Number of holes	Dimensions								Fitting dimensions	
	d ₁	D	B		C _u	Dynamic	Static	e	Y ₁	Y ₂				Y ₃	rpm	kg	b	K	r ₁	d ₂	B ₁	B ₂	b ₁
	mm			kN		kN					mm												
KIT10X22208EAKW33EE	35	80	28	11,2	116	105	0,27	2,47	3,67	2,41	2300	1	3	5,4	2,5	1,1	58	46	13	6	2,5	73,9	1
KIT10X22209EAKW33EE	40	85	28	12,7	121	113	0,26	2,64	3,93	2,68	2100	1	3	5,8	2,5	1,1	65	39	13	6	2,5	78,7	1
KIT10X22210EAKW33EE	45	90	28	14,5	130	124	0,24	2,84	4,23	2,78	2000	1,1	3	5,8	2,5	1,1	70	42	14	6	2,5	83	1
KIT10X22211EAKW33EE	50	100	31	18	155	148	0,23	2,95	4,4	2,89	1800	1,4	3	6,4	3	1,5	75	45	14	7	3	93,9	1,5
KIT10X22212EAKW33EE	55	110	34	22,1	187	181	0,24	2,84	4,23	2,78	1600	1,8	3	6,9	3	1,5	80	47	14	7	3	102,5	1,5
KIT10X22213EAKW33EE	60	120	38	25,2	226	224	0,24	2,79	4,15	2,73	1500	2,5	3	7,8	3,5	1,5	85	65	15	7	3	116,4	1,5
KIT10X22214EAKW33EE	60	125	38	28,8	235	240	0,22	3,01	4,48	2,94	1400	2,6	3	7,4	3,5	1,5	92	52	15	8	3,5	117,1	1,5
KIT10X22215EAKW33EE	65	130	38	30,3	224	249	0,22	3,14	4,67	3,07	1300	2,9	3	7,4	3,5	1,5	98	55	16	8	3,5	121,6	1,5
KIT10X22216EAKW33EE	70	140	40	34,5	278	287	0,22	3,14	4,67	3,07	1200	3,5	3	7,9	3,5	2	105	59	18	8	3,5	131,5	2
KIT10X22217EAKW33EE	75	150	44	38,8	324	330	0,22	3,07	4,57	3	1200	4,2	3	7,9	3,5	2	110	63	19	8	3,5	140,8	2
KIT10X22218EAKW33EE	80	160	48	43,3	384	398	0,23	2,9	4,31	2,83	1000	5,3	3	10	4,5	2	120	73	19	10	4	149	2
KIT10X22219EAKW33EE	85	170	51	47,9	416	417	0,23	2,95	4,4	2,89	1100	6,3	3	9,9	4,5	2,1	125	90	20	10	4	158	2
KIT10X22220EAKW33EE	90	180	55	53	472	495	0,24	2,84	4,23	2,78	1000	7,5	3	11	5	2,1	130	97	21	10	4	168	2

This document is the exclusive property of NTN-SNR ROULEMENTS. Any total or partial reproduction hereof without the prior consent of NTN-SNR ROULEMENTS is strictly prohibited. Legal action may be brought against anyone breaching the terms of this paragraph. NTN-SNR ROULEMENTS shall not be held liable for any errors or omissions that may have crept into this document despite the care taken in drafting it. Due to our policy of continuous research and development, we reserve the right to make changes without notice to all or part of the products and specifications mentioned in this document.
© NTN-SNR ROULEMENTS, international copyright 2017.

NTN-SNR ROULEMENTS - 1 rue des Usines - 74000 Annecy
RCS ANNECY B 325 821 072 - Code APE 2815Z - Code NACE 28.15
www.ntn-snr.com

NTN-SNR SOLUTIONS

SNC BEARING KITS

FOR CONVEYORS

QUARRIES, MINES & CEMENT PLANTS



www.ntn-snr.com



With You



**CREATED TO INCREASE
PRODUCTIVITY,
PERFORMANCE AND
RELIABILITY IN HARSH
ENVIRONMENTS**

OPT FOR THE ALL-IN-ONE

Benefits of kit

- More cost-effective than purchasing components separately
- No error in the choice of accessories
- No oversight of elements at the time of the order and/or mounting
- Simplicity of ordering and storage: Only 1 reference to manage
- Cover plate and locating rings included: for mounting fixed or floating bearings

SNC BEARING KITS + ULTAGE OPEN BEARING



SNC pillow block
+ 2 DS double lip seals
+ plug



ULTAGE
Open spherical roller bearing with tapered bore



Withdrawal sleeve



Locating rings

CONTROL UNIT OFFERED



Single-point DRIVE Booster lubrication system and its protection



REDUCTION IN OVERALL OPERATING COSTS:

- Elimination of lubrication intervals
- Savings on your grease consumption

Description	d	Bearing ref.
	Shaft [mm]	SNC
KITSNC22208KDS/DB120HD	35	SNC 508-607
KITSNC22209KDS/DB120HD	40	SNC 509
KITSNC22210KDS/DB120HD	45	SNC 510-608
KITSNC22211KDS/DB120HD	50	SNC 511-609
KITSNC22212KDS/DB120HD	55	SNC 512-610
KITSNC22213KDS/DB120HD	60	SNC 513-611
KITSNC22215KDS/DB120HD	65	SNC 515-612
KITSNC22216KDS/DB120HD	70	SNC 516-613
KITSNC22217KDS/DB120HD	75	SNC 517
KITSNC22218KDS/DB120HD	80	SNC 518-615

Shaft diameters:
from 35 to 80 mm

20 KIT references available:
10 With normal clearance
10 With C3 clearance

On request, possibility of extending the range to other shaft diameters

SNC BEARING KITS + ULTAGE SEALED BEARING



SNC pillow block
+ 2 DS double lip seals
+ plug



ULTAGE
Sealed spherical roller bearing with tapered bore



Specific adapter sleeve



Specific locating rings



REDUCTION IN OVERALL OPERATING COSTS:

The service life of the bearing is increased thanks to its seal, which acts as a guard against pollution

Description	d	Bearing ref.
	Shaft [mm]	SNC
KITSNC10X22208KEEDS	35	SNC 508-607
KITSNC10X22209KEEDS	40	SNC 509
KITSNC10X22210KEEDS	45	SNC 510-608
KITSNC10X22211KEEDS	50	SNC 511-609
KITSNC10X22212KEEDS	55	SNC 512-610
KITSNC10X22213KEEDS	60	SNC 513-611
KITSNC10X22215KEEDS	65	SNC 515-612
KITSNC10X22216KEEDS	70	SNC 516-613
KITSNC10X22217KEEDS	75	SNC 517
KITSNC10X22218KEEDS	80	SNC 518-615

Shaft diameters:
from 35 to 80 mm

20 KIT references available:
10 With normal clearance
10 With C3 clearance

On request, possibility of extending the range to other shaft diameters

NTN-SNR SOLUTIONS

AGR: INSERT BEARINGS FOR CONVEYORS

QUARRIES, MINES & CEMENT PLANTS



www.ntn-snr.com



With You



AGR sealing system

Triple lip L3
Excellent protection against pollution

For lifelong lubrication:

High-performance grease with fill factor of 90%:

- Good protection against wear
- Suitable for heavy loads

Zinc-plated shield
equipped with a single lip seal to seal the contact with the outer ring (zinc-plated)

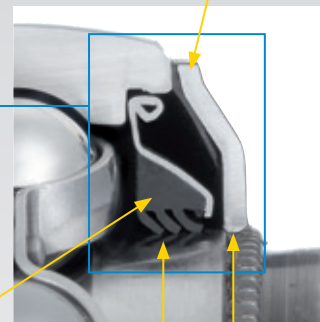

Crimped shield
on inner ring
(zinc-plated)



CREATED TO INCREASE PRODUCTIVITY, PERFORMANCE AND RELIABILITY IN HARSH ENVIRONMENTS

ALL-PURPOSE BEARING

Benefits

- Protection against splashes in very tough environments
- Sealing suitable for high-pressure cleaning
- Lifelong lubricated insert - no need to re-grease

Compatible with all self-aligning cast iron ball bearings in the NTN-SNR range

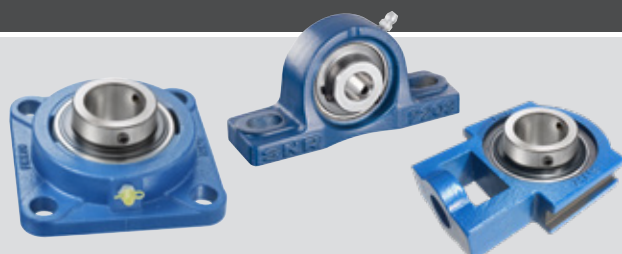

AGR: INSERT BEARINGS FOR CONVEYORS

UC...AGR tightening by set screws (2 possible rotation directions)

Description	d mm	D mm	C mm	B mm	S mm	m mm	G	r mm	Load capacities		Weight kg
									Dyn. (Cr) kN	Stat. (Cor) kN	
UC206AGR ²	30	62	19	39	15,9	5	M6x1	0,6	19,5	11,2	0,31
UC207AGR	35	72	20	42,9	17,5	6,5	M8x1	1,1	25,7	15,2	0,5
UC208AGR	40	80	21	49,2	19	8	M8x1	1,1	29,6	18,2	0,63
UC209AGR	45	85	22	49,2	19	8	M8x1	1,1	31,85	20,8	0,73
UC210AGR	50	90	23	51,6	19	9	M8x1	1,1	35,1	23,2	0,8
UC211AGR	55	100	25	55,6	22,2	9	M8x1	1,5	43,55	29,2	1,1
UC212AGR	60	110	27	65,1	25,4	10,5	M10x1,25	1,5	52,5	32,8	1,37
UC215AGR ¹	75	130	30	77,8	33,3	12	M12x1,25	2	66	49,5	2,16
UC308AGR	40	90	28	58,2	22,22	8,5	M10x1,25	2	40,56	24	1,1
UC309AGR	45	100	30	57	22	9	M10x1,25	2	53	31,8	1,26
UC310AGR	50	110	32	70	26	13	M10x1,25	2	61,75	37,8	1,85

¹ On request (please enquire)

² Wider dimensions than the standard version

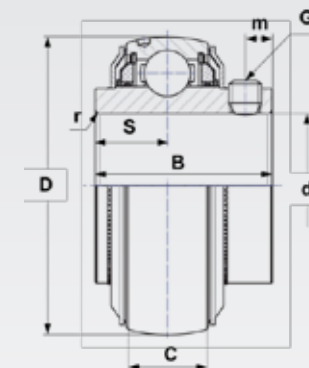

EX...AGR Fixing to shaft using eccentric locking collar (1 rotation direction)

Description	d mm	D mm	C mm	B mm	B1 mm	S mm	d1 mm	m mm	B2 mm	G	r mm	Load capacities		Weight kg
												Dyn. (Cr) kN	Stat. (Cor) kN	
EX207AGR	35	72	20	37,6	51,1	18,8	55,6	6,5	17,5	M8x1	1,1	25,7	15,2	0,64
EX208AGR	40	80	21	42,8	56,3	21,4	60,3	6,5	18,3	M8x1	1,1	29,6	18,2	0,74
EX209AGR	45	85	22	42,8	56,3	21,4	63,5	6,5	18,3	M8x1	1,1	31,85	20,8	0,87
EX210AGR	50	90	23	49,2	62,7	24,6	69,9	6,5	18,3	M8x1	1,1	35,1	23,2	1,01
EX211AGR	55	100	25	55,4	71,3	27,7	76,2	8	20,7	M10x1,25	1,5	43,55	29,2	1,35
EX212AGR	60	110	27	61,8	77,7	30,9	84,2	8	22,3	M10x1,25	1,5	52,5	32,8	1,67
EX308AGR	40	90	28	49,5 ¹	65,3 ¹	22,2 ¹	63,5	8	20,6	M10x1,25	2	40,65	24	1,28

¹ Wider dimensions than the standard version

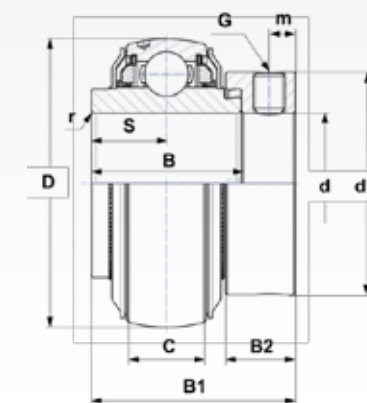

This document is the exclusive property of NTN-SNR ROULEMENTS. Any total or partial reproduction hereof without the prior consent of NTN-SNR ROULEMENTS is strictly prohibited. Legal action may be brought against anyone breaching the terms of this paragraph. NTN-SNR ROULEMENTS shall not be held liable for any errors or omissions that may have crept into this document despite the care taken in drafting it. Due to our policy of continuous research and development, we reserve the right to make changes without notice to all or part of the products and specifications mentioned in this document.
© NTN-SNR ROULEMENTS, international copyright 2018.

NTN-SNR ROULEMENTS - 1 rue des Usines - 74000 Annecy
RCS ANNECY B 325 821 072 - Code APE 2815Z - Code NACE 28.15
www.ntn-snr.com



With You



PLUMMER BLOCK SNCD31

THE NEXT SERIES FOR HIGHEST REQUIREMENTS

NTN® SNR®

www.ntn-snr.com



With You

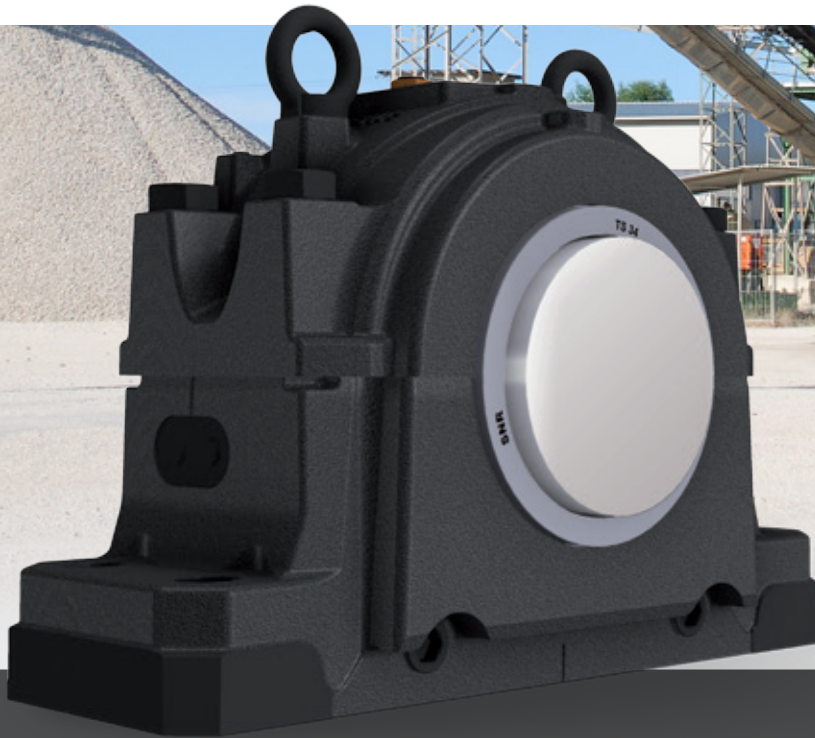

SNCD31 THE NEXT SERIES

After SNCD500 NTN-SNR will continue its range extension with the large **SNCD31** and **30** series for both cylindrical and tapered bore bearings.

The new SNCD31 are consequently made from spheroidal cast material to have highest shock resistance and good low temperature behavior. This series is interchangeable with SD series according to ISO 113.

Extend the life duration with the SNC plummer block housing range!

The optimized design provides excellent rigidity and stability, vibration dampening and improves strength and heat dissipation characteristics in order to provide reduced stress levels in the bearing and a cooler running temperature of its lubricant and thereby extending operating and service life.

The SNCD plummer block housings are designed for installation of spherical roller bearings. We recommend the use of our ULTAGE spherical roller bearings with higher increased load capacities and extended service life, to take advantage of the optimal characteristics of the SNC Housings. We complete our range with the tools and solutions of our service department.

Your benefits:

Improved shape to guarantee excellent stability and rigidity of bearing seat by:

Belt on upper part
Optimized radii



Reinforced bearing seat
Uniform load distribution
>> increased bearing life

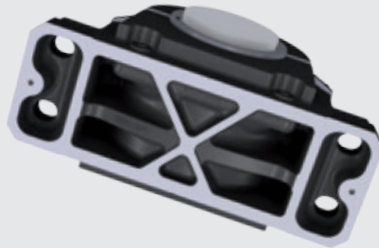

Machined surface in two axes allows a easy alignment during installation

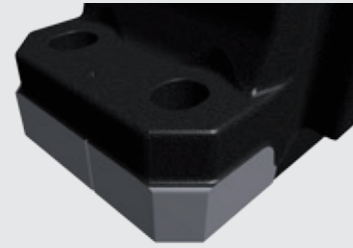

Connection options:

- Delivered with 3 lubrication holes
- 2 grease nipples and added adapter
- 2 x drain holes
- 2 metric threads for vibration measurement
- 1 pipe thread for temperature measurement device
- All bores sealed with screws

Sealing options

SNCD31 are available with 2 different sealing designs. The most common is a basic labyrinth seal. For severe conditions a taconite seal is available consisting of a 2 part axial labyrinth. For shaft end assemblies the housings can be closed with an end cover.

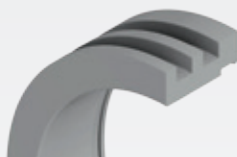

TS seal



TA seal



With our ULTAGE spherical roller bearings you will have a perfect combination of best in class products for your industry, such as:

- Conveyer systems
- Belt pulleys
- Hoists

This document is the exclusive property of NTN-SNR ROULEMENTS. Any total or partial reproduction hereof without the prior consent of NTN-SNR ROULEMENTS is strictly prohibited. Legal action may be brought against anyone breaching the terms of this paragraph. NTN-SNR ROULEMENTS shall not be held liable for any errors or omissions that may have crept into this document despite the care taken in drafting it. Due to our policy of continuous research and development, we reserve the right to make changes without notice to all or part of the products and specifications mentioned in this document. © NTN-SNR ROULEMENTS, international copyright 2017.

ULTAGE



ULTAGE
SPHERICAL ROLLER BEARINGS
Get bigger / Now up to 600 mm



www.ntn-snr.com



With You

NOW YOU CAN BENEFIT FROM ALL THE ADVANTAGES OF THE ULTAGE GENERATION:

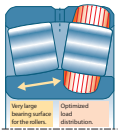

Surface optimisation

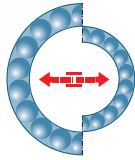

Improved performance
-> reduced dimensions



Increased operating speeds



Reduced friction torque



Reduced power consumption



Reduced operating costs

Designed for applications in extremely harsh operating environments (steelworks, paper mills, wind farms, mines and quarries, etc.), spherical roller bearings need to be able to withstand:

- high loads and temperatures
- major misalignments
- polluted atmospheres
- impacts, vibrations.

All these conditions call for exceptional mechanical qualities.

The NTN-SNR engineers and scientists therefore work tirelessly on:

- materials selection, heat treatments, surface treatments
- product design
- kinematics of bearings when combining the effects of lubrication with reduced friction, wear & tear and pollution
- manufacturing technologies and improvement of the manufacturing processes.

All this effort generates spectacular results.

Thanks to their dynamic load capacities, among the highest on the market, and the optimisation of all constituent parts of the bearing, NTN-SNR ULTAGE spherical roller bearings allow you to benefit from PREMIUM performance:

- **double the service life compared to a standard solution**
- **improved reliability for your installations**
- **reduced costs of use.**



ULTAGE SPHERICAL ROLLER BEARINGS ARE NOW UP TO 600 MM OUTSIDE DIAMETER

NTN-SNR has extended its premium quality to include larger size bearings.

Previously, Ultage Spherical Roller bearings were available with outside diameter up to 420mm. You can now benefit from all the advantages of the Ultage generation on larger size SRB with outside diameters up to 600mm.

The new range is fitted with massive brass cages. They can be ordered with cylindrical or tapered bore. In case of tapered bore, a comprehensive range of adapter sleeves and withdrawal sleeves is available.

List of large size Ultage double-row spherical roller bearings already available

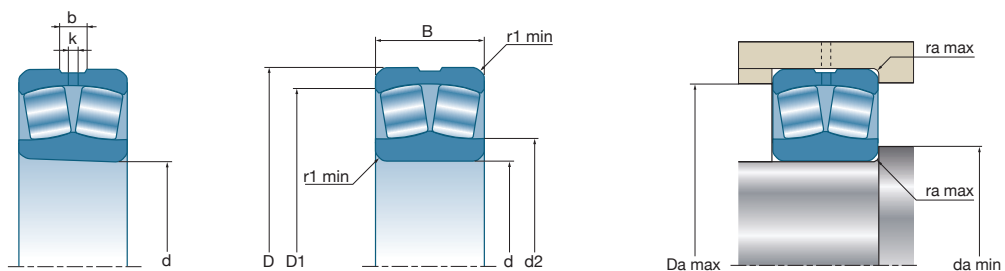

Overall dimensions	d	D	B	ULTAGE	Designations	Load limit fatigue C_u	Basic capacity		Calcul factor				Limit speed	Weight	Number of holes	Dimensions					Fitting dimensions			
							Dynamic C	Static C_0	e	Y_1	Y_2	Y_0				tr/min	kg	b	k	r_1 min	d_2	D_1	d_a min	D_a max
mm	mm	mm	mm		Cylindrical bore	kN	kN								mm	mm	mm	mm	mm	mm	mm	mm	mm	mm
220	460	145	*		22344EMW33	265	3 270	3 680	0,31	2,15	3,2	2,1	1 400	116	8	22,3	12	5	294,3	399,8	240	440	4	
240	400	160	*		24148EAW33	207	2 860	3 990	0,35	1,92	2,86	1,88	1 300	77	3	19,37	12	4	269	348,1	257	383	3	
	440	120	*		22248EMW33	234	2 500	3 550	0,25	2,74	4,08	2,68	1 800	84	8	21,07	12	4	323,5	390,1	257	423	3	
	440	160	*		23248EMW33	240	3 260	4 480	0,35	1,95	2,9	1,9	1 300	107	8	27	16	4	306,4	382,1	257	423	3	
	500	155	*		22348EMW33	307	3 800	4 310	0,31	2,18	3,24	2,13	1 300	147	8	20	12	5	319,9	435,4	260	480	4	
260	400	140	*		24052EAW33	203	2 520	3 820	0,31	2,16	3,22	2,12	1 600	62	3	19,3	8	4	286,2	353,9	275	385	3	
	440	144	*		23152EMW33	233	2 930	4 340	0,3	2,25	3,34	2,2	1 400	91	8	20,15	12	4	322,9	388,9	277	423	3	
	440	180	*		24152EMW33	253	3 690	5 230	0,39	1,72	2,56	1,68	1 200	111	8	28,73	16	4	304	376,7	277	423	3	
	480	174	*		23252EMW33	288	3 940	5 340	0,35	1,92	2,86	1,88	1 300	141	8	27	16	5	328,5	414,1	280	460	4	
280	460	146	*		23156EMW33	257	3 100	4 710	0,29	2,35	3,5	2,3	1 400	97	8	20	12	5	343,3	409,3	300	440	4	
	500	176	*		23256EMW33	302	4 040	5 510	0,33	2,03	3,02	1,98	1 200	148	8	28,9	16	5	350	437,6	300	480	4	
300	460	118	*		23060EMW33	251	2 420	4 230	0,22	3,07	4,57	3	1 500	75	8	16	10	4	369,3	420,1	315	445	3	
	460	160	*		24060EMW33	271	3 390	5 310	0,32	2,11	3,15	2,07	1 300	96	8	27	16	4	345	409,7	315	445	3	
	500	160	*		23160EMW33	303	3 770	5 350	0,29	2,28	3,39	2,23	1 300	127	8	27	16	5	361,6	443,5	320	480	4	
	500	200	*		24160EMW33	314	4 600	6 810	0,38	1,76	2,62	1,72	1 000	157	8	34,8	20	5	350,9	430,5	320	480	4	
320	540	192	*		23260EMW33	356	4 850	6 820	0,34	1,98	2,94	1,93	1 100	195	8	27	16	5	374,1	467,4	320	520	4	
	480	121	*		23064EMW33	274	2 420	4 000	0,24	2,84	4,23	2,78	1 400	80	8	20	12	4	381,6	440	335	465	3	
340	540	176	*		23164EMW33	350	4 370	6 730	0,3	2,25	3,34	2,2	1 200	170	8	27	16	5	394,2	473,2	340	520	4	
	520	133	*		23068EMW33	334	3 220	4 970	0,23	2,9	4,31	2,83	1 400	105	8	20	12	5	401,8	474,9	358	502	4	
360	580	190	*		23168EMW33	398	5 100	7 770	0,31	2,18	3,24	2,13	1 100	215	8	27	16	5	417,6	506,6	360	560	4	
	540	134	*		23072EMW33	353	3 250	5 070	0,21	3,14	4,67	3,07	1 300	110	8	20	12	5	419,8	492,1	378	522	4	
380	600	192	*		23172EMW33	407	5 150	8 160	0,3	2,28	3,39	2,23	1 000	226	8	27	16	5	445,8	531,7	380	580	4	
	560	135	*		23076EMW33	373	3 380	5 620	0,22	3,07	4,57	3	1 200	118	8	20	12	5	442,6	512,5	398	542	4	
400	600	148	*		23080EMW33	417	4 010	6 680	0,22	3,01	4,48	2,94	1 200	153	8	20	12	5	470,4	546,8	418	582	4	

Bearings available with cylindrical or tapered bore. All types of clearances are available on stock or on request. *NTN-SNR ULTAGE bearing. All other Ultage Spherical Roller Bearings from 420mm up to 600mm OD are available upon request.



ULTAGE

SPHERICAL ROLLER BEARINGS

Get bigger / Now up to 600 mm



DOC_L_SRB650_AFIG1.GBa - SAP - 326 015 Conception et réalisation : Service publicité NTN-SNR © 2017 / 03 - Photos : © Pedro Studio Photos - Shutterstock

This document is the exclusive property of NTN-SNR ROULEMENTS. Any total or partial reproduction hereof without the prior consent of NTN-SNR ROULEMENTS is strictly prohibited. Legal action may be brought against anyone breaching the terms of this paragraph.

NTN-SNR ROULEMENTS shall not be held liable for any errors or omissions that may have crept into this document despite the care taken in drafting it. Due to our policy of continuous research and development, we reserve the right to make changes without notice to all or part of the products and specifications mentioned in this document.

© NTN-SNR ROULEMENTS, international copyright 2017.

NTN-SNR ROULEMENTS - 1 rue des Usines - 74000 Annecy
RCS ANNECY B 325 821 072 - Code APE 2815Z - Code NACE 28.15
www.ntn-snr.com



With You



VIBRATING SCREEN
APPLICATIONS
EF800 ULTAGE
Spherical roller bearings



www.ntn-snr.com



With You

OPTIMIZE THE EFFICIENCY OF YOUR SCREENS

THE FEATURES THAT MAKE THE EF800 **ULTAGE**

OPTIMISED MASSIVE BRASS CAGE: PROVEN RELIABILITY

The high radial accelerations of vibrating applications place a particular stress on the cage.

The EF800 series is equipped with a cage able to respond to this.

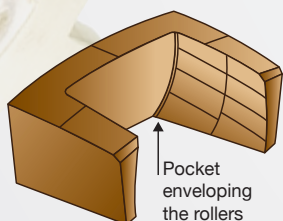
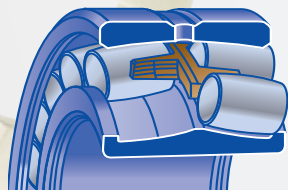

- Symmetrical rollers with a machined brass alloy one-piece cage centered on the rolling elements.
- No floating guide ring or fixed central shoulder section. This prevents any risk of cage/ring seizure in the event of thermal expansion. The self-lubricating properties of the cage material reduce heat build-up at high speeds.
- The contoured profile of the cage pockets, combined with the capacity of the copper alloy to withstand impacts, guarantees the stability of the rolling elements under the harshest of operating conditions.

Pollution, overload, overheating, housing deformation or loss of lubricant efficiency are the mains causes of failure. When initial damage occurs, the massive brass cage ensures a longer service life, allowing the planning of preventive maintenance.

SPECIFIC DIMENSIONAL TOLERANCES: GUARANTEED STABILITY

The EF800 specification sets out reduced bore tolerances for cylindrical bores, for the tapered bores and for the outer diameters, compared with the tolerance ranges of the standard series, guaranteeing perfect ring adjustment.

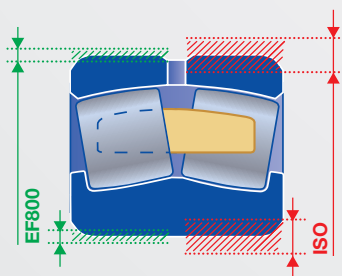

- Cylindrical bore: reduced tolerances to g6 or f6 type.
- Tapered bore: reduced tolerances enabling limitation of the axial displacement of the inner ring when setting the clearance during assembly, thereby facilitating the assembly operations.
- Outer diameter: reduced tolerances to P6 type.

REDUCED INTERNAL RADIAL CLEARANCE: EASY SET-UP

In order to avoid any risk of preload on the bearings, linked to adjustment defects or deformation of the shaft or housing seating surfaces. NTN-SNR proposes a special radial clearance range that facilitates achievement and control of final radial clearance after assembly and takes specific operating conditions into account for these materials.

- EF800 series = C4 with reduced tolerance

Ex. EF800 clearance value vs C4 clearance value

Clearance	22220		Clearance in micron											
	Mini	Maxi	130	135	140	145	150	155	160	165	170	175	180	185
C4	135	180												
EF800 Clearance	165	180												

In certain cases, applications may require the use of a clearance other than C4.

- EF801 series = C3 with reduced tolerance

Why use NTN-SNR EF800 spherical roller bearings?

CUSTOMER BENEFITS

TESTIMONY

EF800 Series is particularly suited to increase the bearing life duration in the most demanding of mine and quarry applications, as may be encountered in screeners, crushers, grinders... AND TO DECREASE MAINTENANCE COSTS.



Romain DELHAYE

Quarry Manager
A2C GRANULAT

“Our installation is subject to very high production demands making availability for maintenance limited. That is why we have to fit machine components, in particular the bearings, with the most reliable and durable equipment possible.

Our aim as quarry operators is to ensure site productivity and efficiency are as high as possible. This keeps **costs down** and **limits machine downtime**.

Crushers and screeners are subject to radial stress due to the large amount of impacts and vibration. NTN-SNR has developed a special range of spherical roller bearings with brass cage : EF800 bearings.

We have seen a real **increase in productivity**, thanks to the quality of NTN-SNR EF800 series.”





EXPERTS & TOOLS

ADDITIONAL TOOLS AND LUBRICATION

A MUST FOR MOUNTING / DISMOUNTING EF800 SERIES (TAPERED BORE)
HYDRAULIC NUT HMV SERIES FROM NTN-SNR

3 GOOD REASONS TO USE HYDRAULIC NUTS FROM NTN SNR

- The most professional tool to provide the drive up force required
- Precise and reliable adjustment of radial bearing clearance
- Cost effective, easy to use and secure, it will reduce your down time



Request catalogue

TOTALLY ADAPTED FOR GREASING EF800 SERIES

LUBRICATION **VIB VIBRATIONS & SHOCKS** FROM NTN-SNR

This grease is an ideal lubricant for parts subjected to extensive vibrations or impact. Recommended for quarries, cement plants, public works operations, high-load applications in humid, dusty and muddy environments.

STANDARD APPLICATIONS

Shafts in scoops, crushers, grinders, vibrating screeners, scalpers, feeders, washing machines, industrial fans, etc.

BENEFITS

Excellent resistance to impact, vibrations and heavy loads, excellent resistance to water guaranteeing long-term lubrication.

TEMPERATURE RANGE

From -20°C to +140°C.

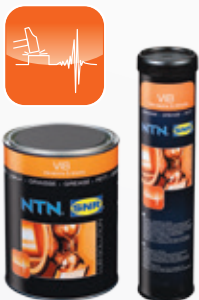

Request catalogue

EASY DISMOUNTING FOR EF800 TO AVOID FRETTING CORROSION

ANTI-FRETTING PASTE

The NTN-SNR anti-fretting paste is specially designed to prevent contact rust between 2 metal surfaces.

COMMERCIAL REFERENCES

- LUB ANTI FRETTING PASTE / T 60G
- LUB ANTI FRETTING PASTE / B 750G



This document is the exclusive property of NTN-SNR ROULEMENTS. Any total or partial reproduction hereof without the prior consent of NTN-SNR ROULEMENTS is strictly prohibited. Legal action may be brought against anyone breaching the terms of this paragraph.

NTN-SNR ROULEMENTS shall not be held liable for any errors or omissions that may have crept into this document despite the care taken in drafting it. Due to our policy of continuous research and development, we reserve the right to make changes without notice to all or part of the products and specifications mentioned in this document.

© NTN-SNR ROULEMENTS, international copyright 2017.





HEAVY INDUSTRY
**OUR LUBRICATION SOLUTIONS
TAILORED TO YOUR NEEDS**
benefits of automatic lubrication



www.ntn-snr.com



With You

1

REVIEW OF APPLICATION/EQUIPMENT TYPE

4 MAIN APPLICATIONS TO FOCUS ON:

Electric motor lubrication

Points to check:

- Motor manufacturer's recommendations
- Motor speed
- Grease trap / escape port design, access and condition
- Bearing types
- Historical lubrication practices
- Requirements for safe access
- Desired service schedule
- Location of lubrication points on bearing housings



Industry: **mining**

Application: **electric motor bearings**

Lubrication system: **NTN-SNR DRIVE BOOSTER**

Installation solution: **remote beam clamp mount**

Fan bearing and seal lubrication

Points to check:

- Bearing types & speeds
- Seal types
- Characteristics of recommended lubricant
- Operating conditions
- Historical lubrication practices
- Requirements for safe access
- Desired service schedule
- Location of grease entry points on bearing housings



Industry: **power plant**

Application: **fan / blower bearings**

Lubrication system: **NTN-SNR DRIVE BOOSTER**

Installation solution: **remote beam clamp mount**

Slurry pump lubrication

Points to check:

- Pump manufacturer's recommendations
- Seal types
- Characteristics of recommended lubricant
- Typical bearing operating temperatures
- Operating conditions
- Bearing types, lubrication points and grease migration directions
- Historical lubrication practices
- Desired service schedule
- Wash down procedures
- Requirements for safe access



Industry: **quarry**

Application: **slurry pump**

Lubrication system: **NTN-SNR DRIVE BOOSTER**

Installation solution: **remote beam clamp mount**

Conveyor pulley bearing lubrication

Points to check:

- Bearing types & speeds
- Seal types
- Characteristics of recommended lubricant
- Operating conditions
- Historical lubrication practices
- Requirements for safe access
- Desired service schedule
- Location of lubrication points on bearing housings



Industry: **quarry**

Application: **conveyor bearing / seal (hybrid solution)**

Lubrication system: **NTN-SNR DRIVE BOOSTER**

Installation solution: **remote beam clamp mount**

2







CHOICE OF INSTALLATION METHOD

REMOTE INSTALLATION DECISION MAKING

In many cases, it is safer to install remote mount lubrication systems as access can't be free from hazards while machinery is operating.















A “**YES**” to any of the questions indicates that remote mounting is likely to be required.







1. Is it necessary to remove protective guards or safety cages to access the lubrication point?
2. Is it difficult or unsafe-to-access the lubrication point while equipment is running?
3. Is the lubrication point subject to severe vibration or high temperatures which may damage the lubrication system?
4. Is it necessary to get permits to access lubrication points such as those in confined spaces or located at heights?
5. Is the lubrication point exposed to excessive amounts of water, process materials or impact from solid material?

NO > Direct mounting		YES > Remote mounting	
			
			
<p>Common mounting - DRIVE BOOSTER ACCESSORIES</p> <p>A 1 x Reducer G1/8 male x G1/4 female 1 x Reducer M6 male x G1/4 female 1 x Reducer M8x1 male x G1/4 female 1 x Reducer M10x1 male x G1/4 female</p> <p>B 1 x Extension 45 mm G1/4 male x G1/4 female</p> <p>C 1 x Angle 45° or 90° G1/4 male x G1/4 female</p> <p>D 1 x Support flange LUBER PROTECTION BASE G1/4 male x G1/4 female</p>	<p>Common mounting - READY BOOSTER ACCESSORIES</p> <p>A 1 x Reducer G1/8 male x G1/4 female 1 x Reducer M6 male x G1/4 female 1 x Reducer M8x1 male x G1/4 female 1 x Reducer M10x1 male x G1/4 female</p> <p>B 1 x Extension 45 mm G1/4 male x G1/4 female</p> <p>C 1 x Angle 45° or 90° G1/4 male x G1/4 female</p> <p>D 1 x Support flange LUBER READY PROTECTION BASE G1/4 male x G1/4 female</p>	<p>Standard duty INSTALLATION KITS</p> <p>They are highly versatile and can be adapted for attachment to beam sections or square mesh safety cages.</p>	<p>Heavy duty INSTALLATION KITS</p> <p>They have been specifically designed for use in operational areas which are subject to regular wash down and water impact, such as the conditions found in coal handling preparation plants.</p>

3

CHOICE OF LUBRICATION SOLUTION AND LUBRICANT POINT

CHOICE OF SINGLE-POINT LUBRICATION SYSTEM			
	READY 	SMART 	DRIVE 
			
	-20° to 60°C	-20° to 60°C	-10° to 60°C
	Max 5 Bar	Max 6 Bar	6 Bar
	60 / 125 cm ³	125 cm ³	120 / 250 cm ³
	1, 2, 3... 12 months at +20 °C / UNIVERSAL+ without counter pressure	1, 2, 3... 12 months independent of operating temperature	1, 2, 3... 12 months independent of operating temperature and counter pressure
	< 2 meter hose extension at +20 °C with lubricant UNIVERSAL+, hose iØ 9.5 mm		< 5 meter hose extension at +20 °C with lubricant UNIVERSAL+, hose iØ 9.5 mm
	IP 68	IP 65	IP 65
	CE Ex	CE Ex	CE

FOR YOUR APPLICATION				
0 limited suitability + suitable ++ very suitable	 conveyors	 electric motors	 pumps	 blowers / fans
READY 	+	+	+	+
SMART 	0	+	0	+
DRIVE 	++	++	++	++
Regular load GREASES (high speed greases)				
Shell Gadus S2 V100 2 (Alvania RL 2) *		•		•
Shell Gadus S5 T100 2 (Stamina RLS 2) *		•		•
ExxonMobil MOBIL POLYREX EM*		•		•
Castrol Spheerol AP 2*		•		•
NTN SNR LUB UNIVERSAL+		•		•
Multipurpose GREASES (extreme pressure greases)				
NTN SNR LUB HEAVY DUTY+	•		•	
Shell Gadus S3 V220C 2 (Albida EP 2) *	•		•	

* Grease available on demand only. MOQ will apply



4 SELECTION OF THE INSTALLATION KIT

STANDARD DUTY KITS

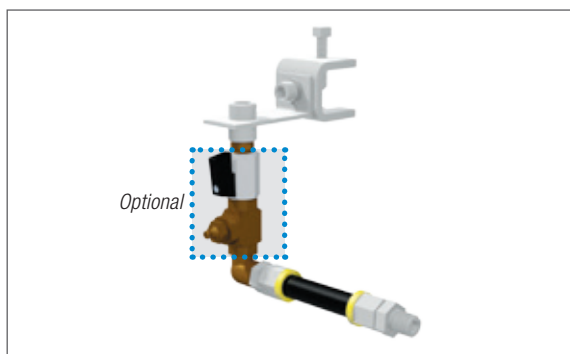

Installation kit standard duty beam clamp mount

READY / SMART BOOSTER
1-point beam clamp mount incl. 1 m hose

 30 mm	LUBER SDKIT 1P 30 mm BEAM CLAMP
 65 mm	LUBER SDKIT 1P 65 mm BEAM CLAMP

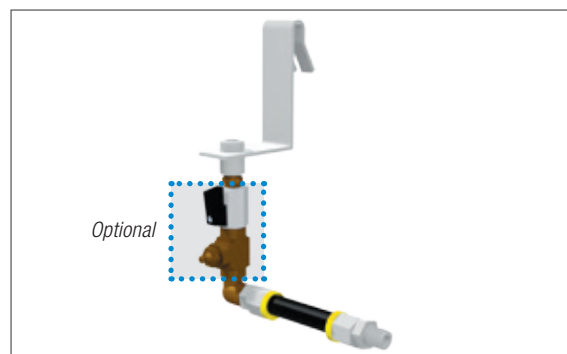

Installation kit standard duty cage hanger mount

READY / SMART BOOSTER
1-point cage hanger mount incl. 1 m hose

LUBER SDKIT 1P CAGE HANGER

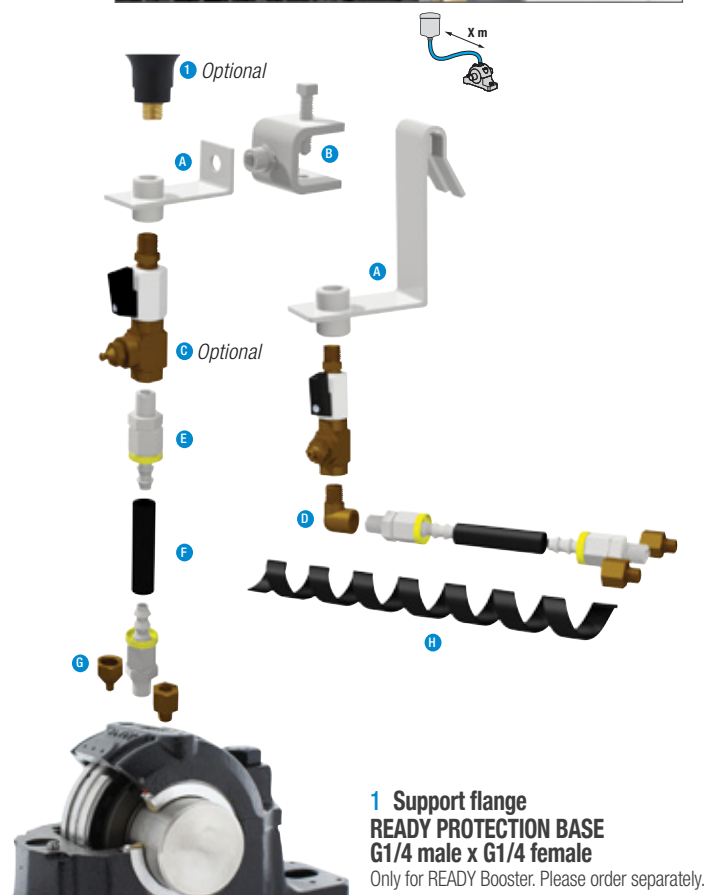

1 Support flange
READY PROTECTION BASE
G1/4 male x G1/4 female
Only for READY Booster. Please order separately.

A Brackets

Compact stainless steel brackets. Can be easily attached to square cage mesh using a hook attachment design or to beam sections using beam clamps.

B Beam clamp

Easy-to-use beam clamps, supplied with case hardened cup head set screws and stainless steel assembly screws. **30 or 65 mm available.**

C Purge connection with manual valve G1/4 (optional)

Used for convenient additions of supplementary grease, line purging and grease blockage cleaning.
LUBER PURGE w MANUAL VALVE

D Angle 90° R1/4 male x G1/4 female

E Hose connector G1/4 male

For hose iØ 9.5 mm. Two included per lubrication point.

F Heavy Duty hose

Supplied with iØ 9.5 mm : 1 m per lubrication point is included.

G Reducing adapter

Three reducers R1/8, R1/4 and M10x1 included for each lubrication point.

H Hose spiral guard

4'

SELECTION OF THE INSTALLATION KIT HEAVY DUTY KITS

INSTALLATION KIT HEAVY DUTY BEAM CLAMP MOUNT



1 point beam clamp mount for DRIVE BOOSTER.
incl. 2 m hose

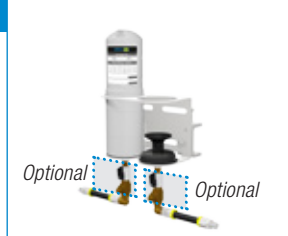

2 points beam clamp mount for DRIVE BOOSTER.
incl. 4 m hose

INSTALLATION KIT HEAVY DUTY CAGE HANGER MOUNT



1 point cage hanger mount for DRIVE BOOSTER.
incl. 2 m hose

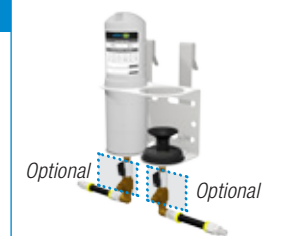

2 points cage hanger mount for DRIVE BOOSTER.
incl. 4 m hose

LUBER HDKIT 1P 30 mm BEAM CLAMP	 30 mm	LUBER HDKIT 2P 30 mm BEAM CLAMP
LUBER HDKIT 1P 65 mm BEAM CLAMP	 65 mm	LUBER HDKIT 2P 65 mm BEAM CLAMP

LUBER HDKIT 1P CAGE HANGER	LUBER HDKIT 2P CAGE HANGER
----------------------------	----------------------------

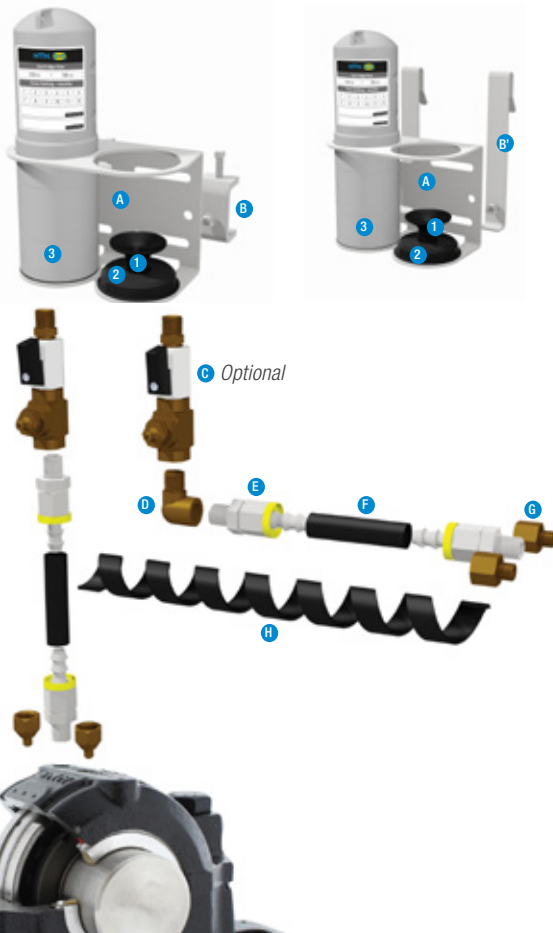

A Brackets incl.

1. Support flange DRIVE
2. Cover clip for protection cap
3. Protection cap DRIVE BOOSTER Heavy Duty 250 (plastic)

Compact stainless steel brackets. Can be easily attached to square cage mesh using a hook attachment design or to beam sections using beam clamps.

B Beam clamp

Easy-to-use beam clamps supplied with case hardened cup head set screws and stainless steel assembly screws. **30 or 65 mm available.**

B' Cage hanger arm (stainless steel)

C Purge connection with manual valve G1/4 (optional)

Used for convenient additions of supplementary grease, line purging and grease blockage cleaning.

LUBER PURGE w MANUAL VALVE

D Angle 90° R1/4 male x G1/4 female

E Hose connector G1/4 male

For hose iØ 9.5 mm . Two included per lubrication point.

F Heavy Duty hose

Supplied with iØ 9.5 mm hose 2 m per point.

G Reducing adapter

Three reducers R1/8, R1/4 and M10x1 included for each lubrication point.

H Hose spiral guard

HEAVY INDUSTRY: OUR LUBRICATION SOLUTIONS TAILORED TO YOUR NEEDS

BENEFITS OF AUTOMATIC LUBRICATION

Only appropriate lubrication can guarantee the optimal operation of bearings and the related mechanical assembly.
55% of premature bearing failures are caused by inappropriate lubrication.

Too much grease

- Increase in operating temperature
- Degradation of grease with high speed bearings
- use of fresh grease not optimized
- Possibility to damage contact type seals

Too little grease

- Premature wear
- Under-lubrication leads to accelerated degradation of remaining grease
- Risk of contamination entry due to lack of lubricant purge

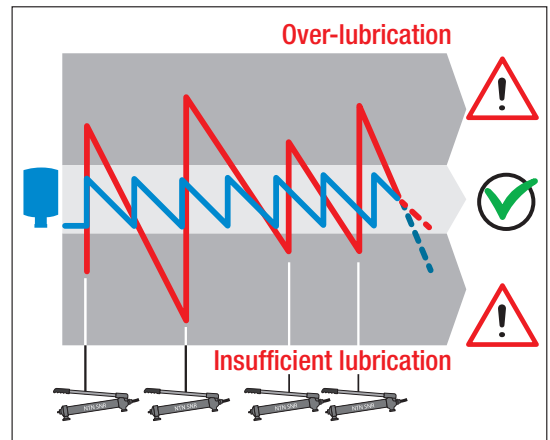

The automatic lubricator can be used to ensure the constant and regular lubrication of your bearings. The lubricator is easy to integrate and can be used to optimize lubrication without any need to modify your installations.

WHY AND WHERE DO WE NEED AUTOMATIC LUBRICATORS

1) Prevention of bearing contamination

- Pump seal purging
- Conveyor pulley bearing re-lubrication & seal purging
- Lubrication of bearing & seal purging at the same time



2) Improvement in safety & efficiency

- Remotely mounted lubrication system used for a conveyor pulley where the bearings are mounted behind a guard thereby avoiding unnecessary access
- Automatically relubricate equipment in confined spaces or at excess height where a permit may be required
- Remotely mounted lubrication systems at ground level for difficult to access equipment such as large electric motors, fans and pumps

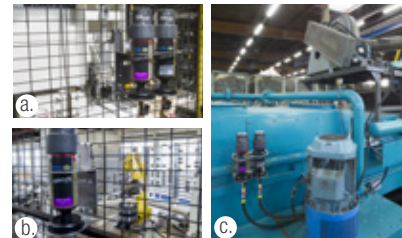

Safety gain: Improve safety by avoiding the need to lift, handle cages or guards, to perform work at heights, or within confined spaces by providing safe to access locations for the lubricators.

Efficiency gain: Save time which would otherwise be required during shutdowns for permits, isolations, equipment preparation and other time consuming requirements.

REVIEW & SELECTION PROCEDURE

4 SIMPLE STEPS TO CHOOSE THE RIGHT LUBRICATION SOLUTION

1
Review of the application or equipment type

2
Choice of installation method

3
Choice of lubrication solution and lubricant type

4 **4'**
Selection of the installation kit



HEAVY INDUSTRY OUR LUBRICATION SOLUTIONS

This document is the exclusive property of NTN-SNR ROULEMENTS. Any total or partial reproduction hereof without the prior consent of NTN-SNR ROULEMENTS is strictly prohibited. Legal action may be brought against anyone breaching the terms of this paragraph.

NTN-SNR ROULEMENTS shall not be held liable for any errors or omissions that may have crept into this document despite the care taken in drafting it. Due to our policy of continuous research and development, we reserve the right to make changes without notice to all or part of the products and specifications mentioned in this document.

© NTN-SNR ROULEMENTS, international copyright 2017.

NTN-SNR ROULEMENTS - 1 rue des Usines - 74000 Annecy
RCS ANNECY B 325 821 072 - Code APE 2815Z - Code NACE 28.15
www.ntn-snr.com



With You

