

RODAMIENTOS DE **RODILLOS CÓNICOS**

La oferta completa NTN: dimensiones métricas y en pulgadas



www.ntn-snr.com



With You

NTN-SNR La fuerza de un grupo

Entidad europea de NTN Corporation, 3er grupo mundial de rodamientos, NTN-SNR ROULEMENTS está especializada en el diseño, desarrollo y la fabricación de rodamientos de rodillos cónicos. Experta en la gestión del ciclo de vida del producto, NTN-SNR se caracteriza por la proximidad y el compromiso de sus equipos. Anticipamos los proyectos de evolución en sus mercados estratégicos. Nuestros ingenieros diseñan con usted soluciones adaptadas a las aplicaciones más exigentes.

Con:

- Cerca de 100 millones de rodamientos de rodillos cónicos producidos cada año;
- una gama completa en pulgadas y en métricas,
- fábricas en Europa y Japón,
- almacenes de enlace 100 % dedicados a la distribución industrial.

**NTN-SNR LE ACOMPAÑA
HACIA LA FIABILIDAD Y EL RENDIMIENTO**



ÍNDICE

Nuestros compromisos	4
Nuestra oferta	6
Dimensiones en pulgadas	6
Dimensiones métricas	7
Nuestra fuerza: el acero de cementación	8
Nuestros mercados, nuestras aplicaciones	9
Prefijos y sufijos	10
Nuestras tablas	11

DATOS TÉCNICOS

Índice de dimensiones en pulgadas (por código de artículo)	12
Gama dimensiones en pulgadas (por diámetro interior)	16
Gama dimensiones métricas (por diámetro interior)	27



Nuestros **compromisos**

HEMOS SELECCIONADO LAS REFERENCIAS MÁS ADECUADAS PARA ASEGURAR LA DISTRIBUCIÓN MÁS EFICAZ.



LA OFERTA COMPLETA: DIMENSIONES EN PULGADAS Y MÉTRICAS

Los grandes estándares de las dos familias de rodamientos (pulgadas y métricas) de una hilera, se reagrupan en una oferta común bajo la marca NTN.



UNA CALIDAD PREMIUM, RODAMIENTOS 100 % JAPONESES

Fabricados al 100 % en nuestras fábricas japonesas de última generación, nuestros productos se someten a controles regulares de calidad, desde la producción hasta el transporte.



UN STOCK EUROPEO PARA REDUCIR LOS PLAZOS DE ENTREGA

Un stock dedicado a la distribución para asegurar la entrega de piezas lo antes posible. Consulte la disponibilidad de nuestros productos en tiempo real a través de nuestro portal e-shop (eshop.ntn-snr.com).



PRODUCTOS DE LA MARCA NTN

Nuestros productos son suministrados en una caja azul NTN robusta, diseñada para soportar los posibles impactos durante el transporte. Ya sea en barco o en camión.



UN SOPORTE TÉCNICO BASADO EN EUROPA PARA ACOMPAÑARLE

Recomendaciones para sus aplicaciones específicas, formaciones de producto, consejos de montaje, nuestros expertos NTN-SNR están a su lado.



En su negocio, nuestras herramientas online le ayudan:

- Equivalencias de productos
- Fichas técnicas
- Tramitación de pedidos

Para obtener una información más detallada por artículo,

Consulte nuestro e-shop
¡Escanéeme!



Nuestra oferta

DIMENSIONES EN PULGADAS

SERIES

LA GAMA DE DIMENSIONES EN PULGADAS CUENTA CON **20 VECES MÁS** SERIES QUE LA GAMA DE DIMENSIONES MÉTRICAS.

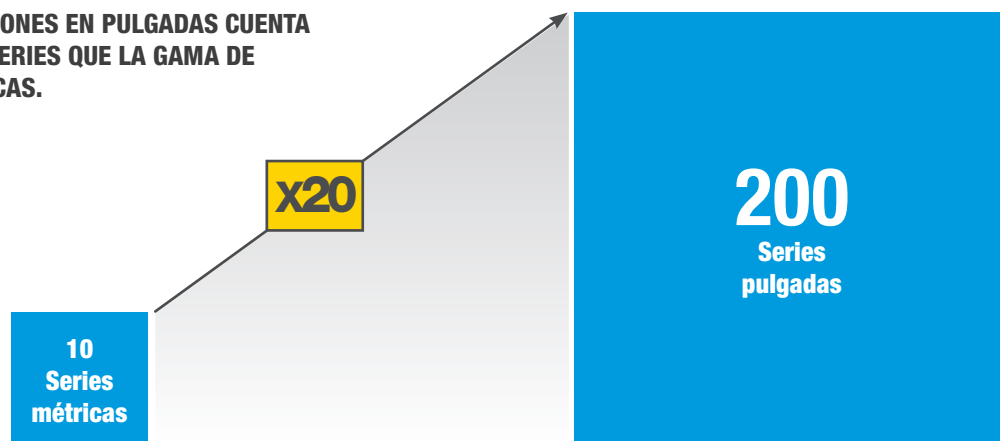

DESIGNACIONES

NUESTRAS DENOMINACIONES SON IDÉNTICAS A LAS DE OTROS ACTORES DEL MERCADO.

El glosario de referencias se compone de 2 partes.



Todas nuestras referencias cumplen la norma ABMA



ACEROS

EL **100%** DE NUESTRAS REFERENCIAS DE DIMENSIONES EN PULGADAS SON DE **ACERO DE CEMENTACIÓN**

(ver detalles en la página 8)



DIMENSIONES MÉTRICAS

SERIES

LA GAMA DE RODAMIENTOS DE RODILLOS CÓNICOS DE DIMENSIONES MÉTRICAS CUENTA CON **10 SERIES NORMALIZADAS**

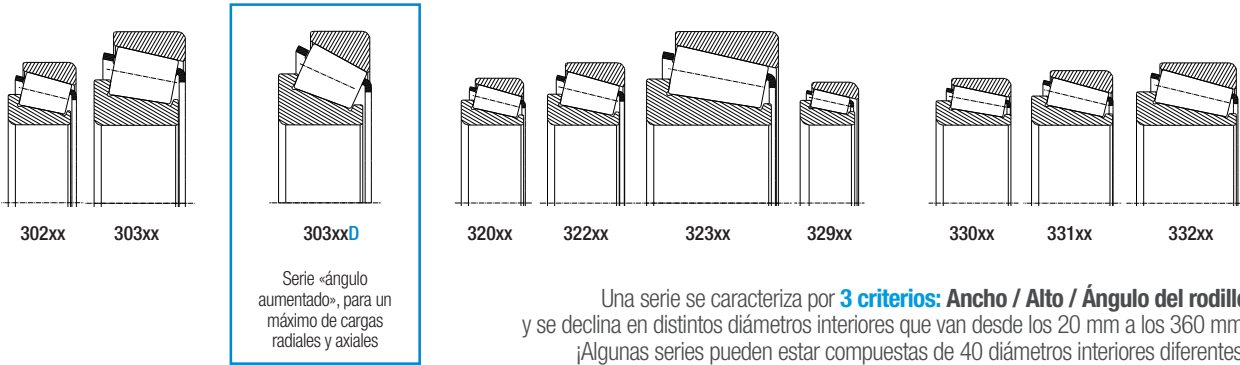

DESIGNACIONES

Por encima de 20 mm, el diámetro interior se calcula multiplicando las dos últimas cifras de la referencia por 5.



322 12 U

12 X 5 = 60 MM

En este ejemplo, el diámetro interior resulta ser de **60 mm**.

Todas nuestras referencias cumplen con la norma ISO



ACEROS

SE UTILIZAN DOS ACEROS EN LA COMPOSICIÓN DE NUESTRAS REFERENCIAS DE DIMENSIONES MÉTRICAS:

- El acero templado a fondo;
- El acero de cementación

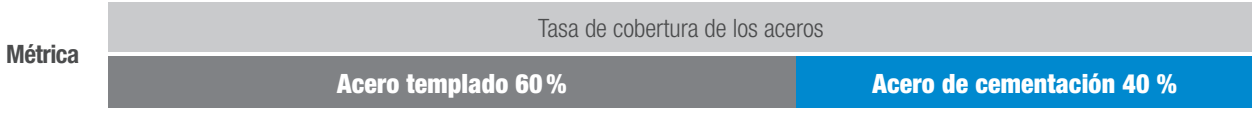

Nuestra fuerza: el acero de cementación



Rémy Dubouchet
Servicio Diseño Industrial

“ La cementación es el proceso de introducción de carbono en la capa superficial de los componentes de un rodamiento. El acero se vuelve más resistente a la fatiga superficial y su núcleo resistente permite una mejor absorción de los impactos. **Para un uso en condiciones extremas, el acero de cementación es sin duda la mejor opción.** ”

VISTA DE CORTE DEL RODAMIENTO DE ACERO DE CEMENTACIÓN:

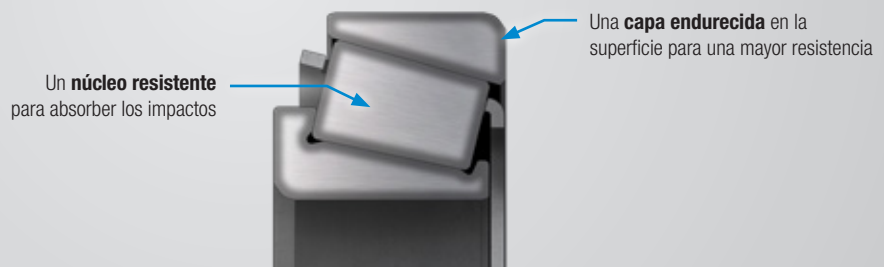

BENEFICIOS

DURACIÓN DE VIDA AUMENTADA

+40%

En condiciones extremas de impactos y fuertes cargas, el acero de cementación mejora la duración de vida en un 40 %, en comparación con el acero templado.



RESISTENTE
A LOS IMPACTOS



RESISTENTE
A FUERTES CARGAS



RESISTENTE
A LA HUMEDAD



RESISTENTE
AL CALOR

COMPROMISO CON LA CALIDAD

En NTN-SNR, la cementación se aplica sobre 3 componentes del rodamiento:

- ① Anillo interior
- ② Anillo exterior
- ③ Rodillo



IDENTIFICACIÓN

Todas nuestras referencias en acero de cementación se reconocen gracias al prefijo **4T-**



ÚNICO EN EL MERCADO

Nuestros mercados, **nuestras aplicaciones**

LOS EXPERTOS DE NTN-SNR TRABAJAN CONSTANTEMENTE EN LA MEJORA Y LA FIABILIDAD DE LOS PRODUCTOS CON EL OBJETIVO DE RESPONDER DE LA MEJOR MANERA POSIBLE A LAS EXIGENCIAS DE LOS CLIENTES.

HIDRÁULICO MOTOR

Los motores hidráulicos se someten a bajas velocidades que no sobrepasan las 255 revoluciones/minuto y soportan fuertes cargas axiales.



TRANSMISIÓN MOTORREDUCTOR

Los ejes de un motorreductor tienen diferentes restricciones.

Eje de entrada:
• Alta velocidad
• Bajo esfuerzo

Eje de salida:
• Baja velocidad
• Esfuerzos importantes

ENERGÍA PRENSA DE PELLETS

El entorno de las prensas de pellets es complejo. Deben de soportarse fuertes cargas y altas temperaturas que pueden alcanzar los 130°C.



FERROVIARIO EJES

Los rodamientos montados sobre los ejes de trenes resisten a fuertes cargas radiales (peso del vagón de aprox. 20 toneladas), así como a altas velocidades pudiendo alcanzar los 300 km/h.

Prefijos y sufijos

TODAS LAS REFERENCIAS DE ESTE CATÁLOGO SON INTERCAMBIABLES CON LAS DE LA COMPETENCIA. LAS DENOMINACIONES PUEDEN VARIAR DE UN FABRICANTE A OTRO AL AÑADIR PREFIJOS Y SUFIJOS.



PULGADAS



MÉTRICAS

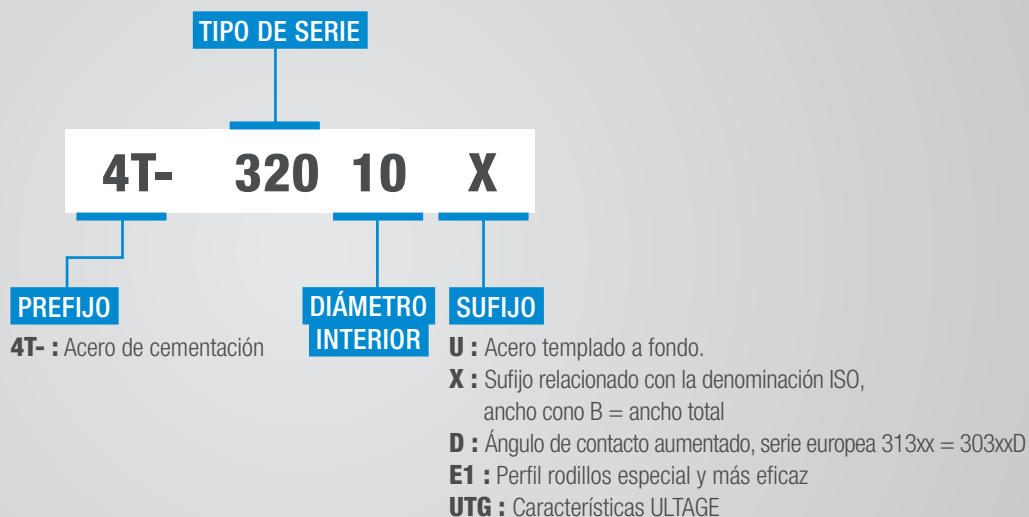

Nuestras **tablas**

¿CÓMO LEER NUESTRAS TABLAS?

1 DIÁMETRO INTERIOR

Entre en la tabla por diámetro interior creciente.

2 DESIGNACIÓN DEL ARTÍCULO

Identifique el glosario simplificado y su equivalente en el glosario estándar NTN.

3 DIMENSIONES

Encuentre las dimensiones de las diferentes dimensiones facilitadas en mm, así como el peso en Kg.

4 CAPACIDADES DE CARGA

Compruebe las capacidades de carga en kN

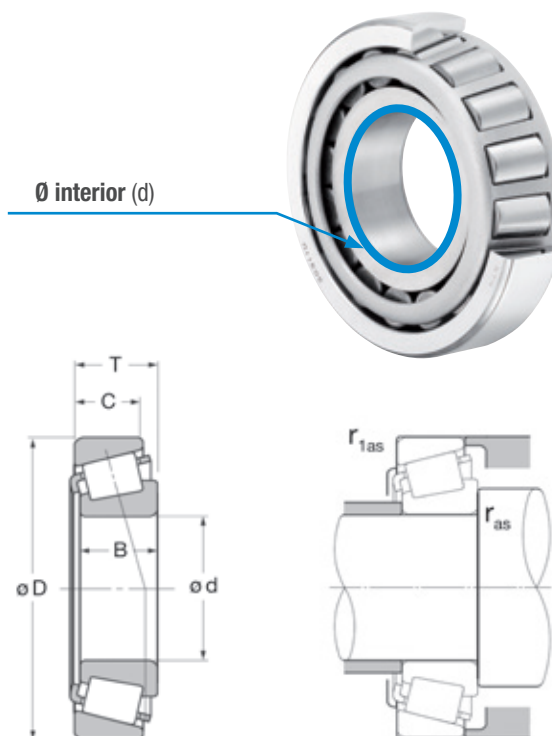

1		2			3				4		
Diámetro interior		Denominación del artículo			Dimensiones				Capacidades de carga		
Diámetro interior (mm)	Glosario simplificado	Glosario NTN	Diámetro exterior	Ancho (mm)		Total	Radio Máx (mm)		Peso (kg)	Capacidades (kN)	
(d)			(D)	Anillo interior (B)	Anillo exterior (C)	(T)	Racores del árbol (ras máx)	Racores del alojamiento (r1as máx)		Carga dinámica (C)	Carga estática (C0)
20	32004	4T-32004X	42	15	12,00	15,00	0,6	0,6	0,097	24,90	27,90
	30204	4T-30204	47	14	12,00	15,25	1,0	1,0	0,127	28,20	28,70
	32204	4T-32204	47	18	15,00	19,25	1,0	1,0	0,160	36,50	39,50

▲ Código europeo simplificado equivalente a la denominación japonesa.

Capacidades de carga dinámicas y estáticas calculadas según la norma ISO. No se ha añadido ningún coeficiente de "refuerzo".

Índice dimensiones en pulgadas (por código de artículo)

Identificar el artículo y encontrar las características técnicas detalladas en la página indicada en la 3ª columna.

DESIGNACIÓN DEL ARTÍCULO	d (mm)	Página
0		
02473/02420	25,400	16
02474/02420	28,575	17
02475/02420	31,750	17
02476/02420	31,750	17
02872/02820	28,575	17
02878/02820	34,925	18
03062/03162	15,875	16
05062/05185	15,875	16
05079/05185	20,000	16
05079/05185S	20,000	16
07079/07196	20,000	16
07087/07196	22,225	16
07087/07210X	22,225	16
07087X/07210X	22,225	16
07098/07204	24,981	16
07100/07196	25,400	16
07100/07204	25,400	16
07100/07210X	25,400	16
07100S/07196	25,400	16
07100S/07204	25,400	16
07100S/07210X	25,400	16
07100SA/07210X	25,400	16
08125/08231	31,750	17
09062/09195	15,875	16
09067/09195	19,050	16
09067/09196	19,050	16
09074/09194	19,050	16
09074/09195	19,050	16
09074/09196	19,050	16
09081/09196	20,625	16
1		
11162/11300	41,275	19
11590/11520	15,875	16
12175/12303	44,450	20
12580/12520	20,638	16
1280/1220	22,225	16
13685/13621	38,100	18
13687/13621	38,100	18
1380/1328	22,225	16
13889/13830	38,100	18
14116/14276	30,226	17
14118/14283	30,000	17
14124/14276	31,750	17
14125A/14274	31,750	17
14125A/14276	31,750	17
14130/14276	33,338	17
14131/14276	33,338	17
14137A/14276	34,925	18
14138A/14274	34,925	18
14138A/14276	34,925	18
15100/15245	25,400	16
15100/15250X	25,400	16
15100S/15245	25,400	16
15100S/15250X	25,400	16
15101/15250X	25,400	16

DESIGNACIÓN DEL ARTÍCULO	d (mm)	Página
15106/15250	26,988	17
15112/15250	28,575	17
15113/15245	28,575	17
15117/15244	29,987	17
15117/15245	29,987	17
15118/15250X	30,213	17
15123/15245	31,750	17
15123/15250X	31,750	17
15125/15245	31,750	17
15578/15520	25,400	16
15578/15523	25,400	16
15580/15520	26,988	17
15590/15520	28,575	17
15590/15523	28,575	17
16150/16282	38,100	18
16150/16283	38,100	18
16150/16284	38,100	18
17098/17244	24,981	16
17118/17244	29,987	17
17119/17244	30,162	17
1755/1729	22,225	16
17580/17520	15,875	16
1779/1729	23,812	16
1780/1729	25,400	16
1780/1730	25,400	16
17887/17831	45,230	20
18590/18520	41,275	19
18685/18620	44,450	20
18690/18620	46,038	20
18790/18720	50,800	21
19150/19268	38,100	18
19150/19268X	38,100	18
19150/19283X	38,100	18
1985/1922	28,575	17
1985/1932	28,575	17
1986/1922	25,400	16
1986/1931	25,400	16
1988/1922	28,575	17
2		
21075/21212	19,050	16
23100/23256	25,400	16
24780/24720	41,275	19
24780/24721	41,275	19
25577/25520	42,875	19
25577/25521	42,875	19
25577/25522	42,875	19
25577/25523	42,875	19
2558/2523S	30,162	17
25580/25520	44,450	20
25580/25521	44,450	20
25580/25522	44,450	20
25580/25523	44,450	20
25581/25520	44,450	20
25584/25520	44,983	20
25584/25521	44,980	20
25590/25520	45,618	20
25590/25521	45,618	20

DESIGNACIÓN DEL ARTÍCULO	d (mm)	Página
25590/25522	45,618	20
25590/25523	45,618	20
2580/2520	31,750	17
2580/2523	31,750	17
2580/2523S	31,750	17
2585/2523	33,338	17
25877/25820	34,925	18
25877/25821	34,925	18
25878/25820	34,925	18
25880/25820	36,487	18
25880/25821	36,487	18
2687/2620	25,400	16
2687/2631	25,400	16
26878/26822	38,100	18
26882/26820	41,275	19
26882/26822	41,275	19
2689/2631	28,575	17
27687/27620	82,550	24
27690/27620	83,345	24
27695/27620	84,976	24
2780/2720	36,487	18
2788/2720	38,100	18
2788/2729	38,100	18
2788/2735X	38,100	18
2789/2720	39,688	19
2789/2729	39,688	19
2790/2720	33,338	17
2793/2720	34,925	18
2796/2729	34,925	18
28137/28317	34,925	18
28150/28300	38,100	18
28158/28300	40,000	19
28580/28521	50,800	21
28584/28521	52,388	21
28680/28622	55,562	21
28682/28622	57,150	22
2878/2820	34,925	18
28985/28920	60,325	22
28985/28921	60,325	22
28995/28921	62,738	22
29585/29520	63,500	22
29585/29521	63,500	22
29586/29520	63,500	22
29586/29522	63,500	22
29590/29520	66,675	23
29590/29521	66,675	23
29590/29522	66,675	23
29675/29620	69,850	23
29685/29620	73,025	23
29688/29620	73,817	23
2984/2924	46,038	20
3		
31593/31520	34,925	18
31594/31520	34,925	18
31597/31520	36,512	18
3188/3120	31,750	17
3188S/3120	31,750	17

DESIGNACIÓN DEL ARTÍCULO	d (mm)	Página
33262/33462	66,675	23
33275/33462	69,850	23
33281/33462	71,438	23
33281/33472	71,438	23
33287/33462	73,025	23
3379/3320	34,925	18
3384/3320	41,275	19
3386/3320	39,688	19
3386/3325	39,688	19
33885/33822	44,450	20
33889/33822	50,800	21
33891/33821	52,388	21
33895/33821	53,975	21
33895/33822	53,975	21
34300/34478	76,200	24
34301/34478	76,200	24
34306/34478	77,788	24
34306/34500	77,788	24
344/332	40,000	19
344A/332	40,000	19
3478/3420	34,925	18
3490/3420	38,100	18
355X/352	44,450	20
355X/354X	44,450	20
3578/3525	44,450	20
3579/3525	42,862	19
3585/3525	41,275	19
3586/3525	45,237	20
359S/354X	46,038	20
365/362	50,000	21
365/362A	50,000	21
36690/36620	146,050	26
368/362	50,800	21
368A/362	50,800	21
368A/362A	50,800	21
36990/36920	177,800	26
369S/362A	47,625	20
37425/37625	107,950	25
37431/37625	109,538	25
37431A/37625	109,538	25
3767/3720	52,388	21
3776/3720	44,983	20
3779/3720	47,625	20
3780/3720	50,800	21
3782/3720	44,450	20
386A/382A	47,625	20
387/382	57,150	22
387/382A	57,150	22
3872/3820	34,925	18
3876/3820	38,100	18
3877/3820	41,275	19
387A/382	57,150	22
387A/382A	57,150	22
387A/382S	57,150	22
387A/383A	57,150	22
387AS/382A	57,150	22
388A/382	57,531	22
390/394A	57,150	22

DESIGNACIÓN DEL ARTÍCULO	d (mm)	Página
390A/394A	63,500	22
39250/39412	63,500	22
395/394A	63,500	22
39580/39520	57,150	22
39581/39520	57,150	22
39585/39520	63,500	22
39590/39520	66,675	23
395A/394	66,675	23
395A/394A	66,675	23
395S/394A	66,675	23
3980/3920	60,325	22
3982/3920	63,500	22
3984/3920	66,675	23
3994/3920	66,675	23
399A/394A	68,262	23
399AS/394A	68,262	23
4		
41125/41286	28,575	17
418/414	38,100	18
420/414	40,000	19
42350/42584	88,900	24
42375/42584	95,250	25
42381/42584	96,838	25
42687/42620	76,200	24
42690/42620	77,788	24
43125/43312	31,750	17
4370/4320	44,450	20
438/432	44,450	20
44150/44348	38,100	18
44162/44348	41,275	19
45284/45220	50,800	21
45285/45220	50,800	21
45287/45220	53,975	21
45289/45220	57,150	22
45291/45220	57,150	22
4580/4535	50,800	21
462/453X	57,150	22
462A/453X	57,150	22
469/453X	57,150	22
47487/47420	69,850	23
47490/47420	71,438	23
47679/47620	76,200	24
47681/47620	80,962	24
47686/47620	82,550	24
47687/47620	82,550	24
47890/47820	92,075	24
47896/47820	95,250	25
48190/48120	107,950	25
482/472	69,850	23
482/472X	69,850	23
48286/48220	123,825	25
48290/48220	127,000	25
48385/48320	133,350	25
48393/48320	136,525	26
484/472	70,000	23
48685/48620	142,875	26
495/492A	82,550	24

DESIGNACIÓN DEL ARTÍCULO	d (mm)	Página
495/493	82,550	24
49585/49520	50,800	21
495A/493	76,200	24
497/492A	85,725	24
497/493	85,725	24
5		
52387/52618	98,425	25
52393/52618	100,012	25
52400/52618	101,600	25
52401/52618	101,600	25
526/522	41,275	19
527/522	44,450	20
528/522	47,625	20
529/522	50,800	21
529X/522	50,800	21
53177/53375	44,450	20
53178/53375	44,450	20
535/532A	44,450	20
536/532X	47,625	20
537/532A	50,800	21
537/532X	50,800	21
539/532X	53,975	21
539S/5335	49,212	21
543/532X	40,000	19
55175C/55437	44,450	20
55176/55437	44,450	20
55187/55443	47,625	20
55187C/55443	47,625	20
55200C/55437	50,800	21
555S/552A	57,150	22
5583/5535	60,325	22
5584/5535	63,500	22
559/552A	63,500	22
560/552A	66,675	23
56418/56650	106,362	25
56425/56650	107,950	25
56426/56650	107,950	25
565/563	63,500	22
566/563	69,850	23
567A/563	71,438	23
568/563	73,817	23
575/572	76,200	24
575/572X	76,200	24
580/572	82,550	24
580/572X	82,550	24
581/572	80,962	24
59200/59412	50,800	21
594/592	95,250	25
594/592A	95,250	25
594/593X	95,250	25
594A/592A	95,250	25
598A/592A	92,075	24

Índice dimensiones en pulgadas (por código de artículo)

Identificar el artículo y encontrar las características técnicas detalladas en la página indicada en la 3ª columna.

DESIGNACIÓN DEL ARTÍCULO	d (mm)	Página
6		
615/612	44,450	20
623/612	57,150	22
6280/6220	53,975	21
6379/6320	65,088	22
6386/6320	66,675	23
639/632	63,500	22
641/632	66,675	23
643/632	69,850	23
64432/64708	109,974	25
64450/64700	114,300	25
645/632	71,438	23
6460/6420	73,025	23
65200/65500	50,800	21
65212/65500	53,975	21
65237/65500	60,325	22
65390/65320	49,212	21
655/653	69,850	23
6559/6535	82,550	24
6580/6535	88,900	24
6581X/6525X	90,000	24
66200/66462	50,800	21
66225/66462	57,150	22
663/653	82,550	24
665/653	85,725	24
66584/66520	53,975	21
67388/67322	127,000	25
67390/67322	133,350	25
67787/67720	174,625	26
67790/67720	177,800	26
683/672	95,250	25
68462/68712	117,475	25
687/672	101,600	25
7		
71450/71750	114,300	25
72200C/72487	50,800	21
72212C/72487	53,975	21
72218C/72487	55,562	21
745A/742	69,850	23
748S/742	76,200	24
749/742	85,026	24
749A/742	82,550	24
759/752	88,900	24
780/772	101,600	25
782/772	104,775	25
78214/78551	53,975	21
78214C/78551	53,975	21
78215C/78551	53,975	21
78225/78551	57,150	22
78238/78537	60,325	22
78250/78551	63,500	22

DESIGNACIÓN DEL ARTÍCULO	d (mm)	Página
8		
835/832	69,850	23
842/832	82,550	24
850/832	88,900	24
861/854	101,600	25
898/892	139,700	26
9		
90381/90744	96,838	25
9185/9121	68,262	23
9278/9220	68,262	23
9285/9220ST	76,200	24
936/932	107,950	25
9378/9321	76,200	24
938/932	114,300	25
95500/95925	127,000	25
95525/95925	133,350	25
98350/98788	88,900	24
98400/98788	101,600	25
99600/99100	152,400	26

DESIGNACIÓN DEL ARTÍCULO	d (mm)	Página
A		
A2047/A2126	11,986	16
A4050/A4138	12,700	16
A4059/A4138	14,989	16
A6075/A6157	19,050	16
H		
H212749/H212710	65,987	22
H414242/H414210	66,675	23
H414245/H414210	68,262	23
H414249/H414210	71,438	23
H715334/H715311	61,912	22
H715341A/H715311	66,675	23
H715343/H715311	68,262	23
H715345/H715310	71,438	23
H715345/H715311	71,438	23
H715347/H715311	69,987	23
H715348/H715311	77,788	24
H913840/H913810	59,987	22
H913842/H913810	61,912	22
H913849/H913810	69,850	23
H917840/H917810	76,200	24
H924045/H924010	111,125	25
HH221434/HH221410	88,900	24
HH221449/HH221410	101,600	25
HH224335/HH224310	101,600	25
HH224349/HH224310V2	114,976	25
HH228340/HH228310	120,650	25
HH228340/HH228310V3	120,650	25
HH228340/HH228318V4	120,650	25
HH228349/HH228310	127,000	25
HH421246/HH421210	98,425	25
HH923649/HH923610	101,600	25
HM		
HM204049/HM204010	45,980	20
HM212047/HM212010	63,500	22
HM212047/HM212011	63,500	22
HM212049/HM212010	66,675	23
HM212049/HM212011	66,675	23
HM215249/HM215210	75,987	23
HM218238/HM218210	79,974	24
HM218248/HM218210	89,974	24
HM220149/HM220110	99,974	25
HM515745/HM515716	76,200	24
HM518445/HM518410	88,900	24
HM617049/HM617010	85,725	24
HM801346/HM801310	38,100	18
HM801346X/HM801310	38,100	18
HM801349/HM801310	40,483	19
HM801349/HM801311	40,483	19
HM803145/HM803110	41,275	19
HM803146/HM803110	41,275	19
HM803149/HM803110	44,450	20

DESIGNACIÓN DEL ARTÍCULO	d (mm)	Página
HM803149/HM803111	44,450	20
HM803149/HM803112	44,450	20
HM804840/HM804810	41,275	19
HM804842/HM804810	44,450	20
HM804843/HM804810PX1	44,450	20
HM804846/HM804810	47,625	20
HM804848/HM804810	48,412	21
HM804849/HM804810	48,412	21
HM807040/HM807010	44,450	20
HM807044/HM807010	49,212	21
HM807046/HM807010	50,800	21
HM807048/HM807010	54,488	21
HM807049/HM807010	53,975	21
HM813840/HM813810	55,562	21
HM813844/HM813810	66,675	23
HM813849/HM813810	71,438	23
HM88542/HM88510	31,750	17
HM88547/HM88510	33,338	17
HM88648/HM88610PX1	35,717	18
HM88649/HM88610	34,925	18
HM89249/HM89210	36,512	18
HM89443/HM89410	33,338	17
HM89446/HM89410	34,925	18
HM89448/HM89410	36,512	18
HM89449/HM89410	36,512	18
HM89449/HM89411	36,512	18
HM903245/HM903210	41,275	19
HM903245/HM903210PX1	41,275	19
HM903248/HM903210	44,988	20
HM903249/HM903210	44,450	20
HM905843/HM905810	44,988	20
HM907643/HM907614	50,800	21
HM911245/HM911210	60,325	22
HM926740/HM926710	114,300	25
HM926745/HM926710	125,298	25
J		
J90354/J90748	90,000	24
JH211749/JH211710PK	65,000	22
JH307749/JH307710	55,000	21
JH415647/JH415610	75,000	23
JH415647/JH415610PK	75,000	23
JHM318448/JHM318410	90,000	24
JHM522649/JHM522610	110,000	25
JHM534149/JHM534110PK	170,000	26
JHM720249/JHM720210	100,000	25
JHM807045/JHM807012	50,000	21
JHM88540/JHM88513PX1	30,000	17
JL68145/JL68111Z	35,000	18
JL69345/JL69310	38,000	18
JL69349/JL69310	38,000	18
JL819349/JL819310	95,000	24
JLM104948/JLM104910	50,000	21
JLM506849/JLM506810	55,000	21
JLM508748/JLM508710	60,000	22

DESIGNACIÓN DEL ARTÍCULO	d (mm)	Página
JLM704649/JLM704610PK	50,000	21
JLM710949/JLM710910	65,000	22
JLM714149/JLM714110PK	75,000	23
JLM813049/JLM813010PK	70,000	23
JM		
JM205149/JM205110	50,000	21
JM205149/JM205110PK	50,000	21
JM207049/JM207010	55,000	21
JM511946/JM511910	65,000	22
JM515649/JM515610PK	80,000	24
JM612949/JM612910PK	70,000	23
JM714249/JM714210PK	75,000	23
JM716648/JM716610PK	85,000	24
JM716649/JM716610	85,000	24
JM718149/JM718110PK	90,000	24
JM719149/JM719113	95,000	24
JM720249/JM720210	100,000	25
JM734449/JM734410	170,000	26
JM736149/JM736110	180,000	26
JM738249/JM738210	190,000	26
JM822049/JM822010	110,000	25
L		
L116149/L116110PX2	82,550	24
L21549/L21511	15,875	16
L217849/L217810	88,900	24
L225849/L225810	127,000	25
L319249/L319210	95,250	25
L327249/L327210	133,350	25
L420449/L420410	101,600	25
L432349/L432310	158,750	26
L433749/L433710	158,750	26
L44643/L44610	25,400	16
L44643L/L44610	25,400	16
L44649/L44610	26,988	17
L45449/L45410	29,000	17
L610549/L610510	63,500	22
L624549/L624510	120,650	25
L68149/L68110	34,988	18
L68149/L68111	34,988	18
L713049/L713010	69,850	23
L814749/L814710	76,200	24
LL225749/LL225710	127,000	25
LL319349/LL319310	95,250	25
LL639249/LL639210	196,850	26
LM		
LM102949/LM102910	45,242	20
LM104949/LM104911	50,800	21
LM104949/LM104912	50,800	21
LM11749/LM11710	17,462	16
LM11949/LM11910	19,050	16
LM11949L/LM11910	19,050	16
LM12749/LM12710	21,986	16

DESIGNACIÓN DEL ARTÍCULO	d (mm)	Página
LM12749/LM12711	21,986	16
LM29748/LM29710	38,100	18
LM29748L/LM29710	38,100	18
LM29749/LM29710	38,100	18
LM29749/LM29711	38,100	18
LM300849/LM300811	41,000	19
LM48548/LM48510	34,925	18
LM48548L/LM48510	34,925	18
LM501349/LM501310	41,275	19
LM501349/LM5013 11	41,275	19
LM501349/LM501314	41,275	19
LM503349/LM503310	46,000	20
LM503349A/LM503310	45,987	20
LM522548/LM522510	109,987	25
LM522549/LM522510	109,987	25
LM603049/LM603011	45,242	20
LM603049/LM603012	45,242	20
LM603049/LM603014	45,242	20
LM67048/LM67010	31,750	17
LM67048L/LM67010	31,750	17
LM67049A/LM67010	31,750	17
LM72849/LM72810PX1	22,606	16
LM78349/LM78310APX2	34,988	18
LM806649/LM806610	53,975	21
LM814849/LM814810	77,788	24
M		
M12648/M12610	22,225	16
M12649/M12610	21,430	16
M201047/M201011	39,688	19
M231649/M231610	152,400	26
M236849/M236810	177,800	26
M238849/M238810	187,325	26
M802048/M802011	41,275	19
M804049/M804010	47,625	20
M84249/M84210	25,400	16
M84548/M84510	25,400	16
M84549/M84510	26,988	17
M86643/M86610	25,400	16
M86647/M86610	28,575	17
M86649/M86610	30,162	17
M88040/M88010	28,575	17
M88043/M88010	30,162	17
M88046/M88010	31,750	17
M88048/M88010	33,338	17
M903345/M903310	41,275	19

Gama dimensiones en pulgadas

(por diámetro interior)

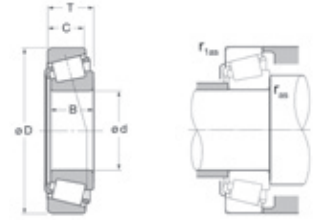

Diámetro interior (mm)	Glosario NTN	Diámetro exterior (D)	Ancho (mm)			Radio Máx (mm)		Peso (kg)	Capacidades (kN)	
			Anillo interior (B)	Anillo exterior (C)	Total (T)	Racores del árbol (r_{as} máx)	Racores del alojamiento (r_{ias} máx)		Carga dinámica (C)	Carga estática (C0)
11,986	4T-A2047/A2126	31,991	10,785	7,938	10,008	0,8	1,3	0,050	10,80	9,45
12,700	4T-A4050/A4138	34,988	10,988	8,730	10,998	1,3	1,3	0,053	12,30	11,60
14,989	4T-A4059/A4138	34,988	10,988	8,730	10,998	0,8	1,3	0,050	12,30	11,60
15,875	4T-L21549/L21511	34,989	10,998	8,712	10,998	1,3	1,3	0,050	14,00	13,70
	4T-03062/03162	41,275	14,681	11,112	14,288	1,3	2,0	0,092	20,30	18,70
	4T-11590/11520	42,862	14,288	9,525	14,288	1,5	1,5	0,103	17,60	17,50
	4T-17580/17520	42,862	16,670	13,495	16,670	1,5	1,5	0,122	26,70	26,00
	4T-05062/05185	47,000	14,381	11,112	14,381	1,5	1,3	0,131	24,00	24,20
17,462	4T-09062/09195	49,225	21,539	14,288	19,845	0,8	1,3	0,203	38,50	39,00
	4T-LM11749/LM11710	39,878	14,605	10,668	13,843	1,3	1,3	0,084	23,80	24,20
19,050	4T-A6075/A6157	39,992	11,153	9,525	12,014	1,0	1,3	0,065	12,80	12,80
	4T-LM11949/LM11910	45,237	16,637	12,065	15,494	1,3	1,3	0,128	28,30	28,60
	4T-LM11949/LM11910	45,237	16,637	12,065	15,494	1,3	1,3	0,122	28,30	28,60
	4T-09067/09195	49,225	19,050	14,288	18,034	1,3	1,3	0,179	38,50	39,00
	4T-09074/09195	49,225	21,539	14,288	19,845	1,5	1,3	0,188	38,50	39,00
	4T-09074/09194	49,225	21,539	17,462	23,020	1,5	3,5	0,200	38,50	39,00
	4T-09067/09196	49,225	19,050	17,462	21,209	1,3	1,5	0,198	38,50	39,00
	4T-21075/21212	53,975	21,839	15,875	22,225	1,5	2,3	0,248	40,00	39,00
20,000	4T-09067/09196	49,225	19,050	17,462	21,209	1,3	1,5	0,198	38,50	39,00
	4T-05079/05185	47,000	14,381	11,112	14,381	1,5	1,3	0,117	24,00	24,20
	4T-05079/05185S	47,000	14,381	11,112	14,381	1,5	1,3	0,117	24,00	24,20
20,625	4T-07079/07196	50,005	14,260	9,525	13,495	1,5	1,0	0,130	26,00	28,00
20,638	4T-09081/09196	49,225	21,539	17,462	23,020	1,5	1,5	0,190	38,50	39,00
20,638	4T-12580/12520	49,225	19,845	15,875	19,845	1,5	1,5	0,182	37,50	39,00
21,430	4T-M12649/M12610	50,005	18,288	13,970	17,526	1,3	1,3	0,169	38,00	39,00
21,986	4T-LM12749/LM12711	45,974	16,637	12,065	15,494	1,3	1,3	0,123	29,60	34,00
	4T-LM12749/LM12710	45,237	16,637	12,065	15,494	1,3	1,3	0,116	29,60	34,00
22,225	4T-07087/07196	50,005	14,260	9,525	13,495	1,3	1,0	0,130	26,00	27,90
	4T-M12648/M12610	50,005	18,288	13,970	17,526	1,3	1,3	0,165	38,00	39,00
	4T-07087/07210X	50,800	14,260	12,700	15,011	1,3	1,5	0,140	26,00	28,00
	4T-07087X/07210X	50,800	14,260	12,700	15,011	1,5	1,5	0,140	26,00	28,00
	4T-1380/1328	52,388	20,168	14,288	19,368	1,5	1,5	0,200	40,50	43,00
	4T-1755/1729	56,896	19,837	15,875	19,368	1,3	1,3	0,256	42,50	46,50
	4T-1280/1220	57,150	22,225	17,462	22,225	0,8	1,5	0,286	47,00	49,50
22,606	4T-LM72849/LM72810PX1	47,000	15,500	12,000	15,500	1,5	1,5	0,125	27,50	32,50
23,812	4T-1779/1729	56,896	19,837	15,875	19,368	0,8	1,3	0,247	42,50	46,50
24,981	4T-07098/07204	51,994	14,260	12,700	15,011	1,5	1,3	0,140	26,00	28,00
	4T-17098/17244	62,000	16,566	14,288	16,002	1,5	1,5	0,260	39,00	42,00
	4T-07100S/07196	50,005	14,260	9,525	13,495	1,5	1,0	0,116	26,00	27,90
25,400	4T-L44643/L44610	51,100	14,732	10,668	14,224	1,3	1,3	0,130	28,80	34,00
	4T-L44643/L44610	50,292	14,732	10,668	14,224	1,3	1,3	0,130	28,80	34,00
	4T-07100/07210X	50,800	14,260	12,700	15,011	1,0	1,5	0,130	26,00	28,00
	4T-07100S/07210X	50,800	14,260	12,700	15,011	1,5	1,5	0,130	26,00	28,00
	4T-07100SA/07210X	50,800	14,260	12,700	15,011	3,3	1,5	0,130	26,00	28,00
	4T-07100/07204	51,994	14,260	12,700	15,011	1,0	1,3	0,144	26,00	27,90
	4T-07100S/07204	51,994	14,260	12,700	15,011	1,0	1,3	0,144	26,00	27,90
	4T-1780/1729	56,896	19,837	15,875	19,368	0,8	1,3	0,238	42,50	46,50
	4T-15578/15520	57,150	17,462	13,495	17,462	1,3	1,5	0,220	39,50	45,50
	4T-1986/1922	57,150	19,355	15,875	19,845	1,3	1,5	0,250	40,50	44,50
	4T-M84548/M84510	57,150	19,431	14,732	19,431	1,5	1,5	0,241	42,00	48,50
	4T-M84249/M84210	59,530	23,114	18,288	23,368	0,8	1,5	0,330	50,00	57,50
	4T-15578/15523	60,325	17,462	15,875	19,842	1,3	1,5	0,271	39,50	45,50
	4T-15100/15245	62,000	20,638	14,288	19,050	3,5	1,3	0,299	46,50	54,00
	4T-15100S/15245	62,000	20,638	14,288	19,050	1,3	1,3	0,299	46,50	54,00
	4T-15100S/15250X	63,500	20,638	15,875	20,638	1,3	1,5	0,320	46,50	54,00
	4T-M86643/M86610	64,292	21,433	16,670	21,433	1,5	1,5	0,371	51,50	64,50
	4T-23100/23256	65,088	21,463	15,875	22,225	1,5	1,5	0,360	47,00	50,50
	4T-2687/2631	66,421	25,433	19,050	23,812	1,3	1,3	0,442	64,50	72,50
	4T-02473/02420	68,262	22,225	17,462	22,225	0,8	1,5	0,430	57,00	67,00
	4T-07100/07196	50,005	14,260	9,525	13,495	1,0	1,0	0,114	26,00	27,00
	4T-1780/1730	53,975	19,837	15,875	19,368	0,8	0,8	0,208	42,50	46,50
4T-1986/1931	60,325	19,355	15,875	19,845	1,3	1,3	0,275	40,50	44,50	
4T-15100/15250X	63,500	20,638	15,875	20,638	3,5	1,5	0,332	46,50	54,00	
4T-15101/15250X	63,500	20,638	15,875	20,638	0,8	1,5	0,335	46,50	54,00	
4T-2687/2620	63,100	25,433	19,050	23,812	1,3	3,3	0,390	64,50	72,50	

Gama dimensiones en pulgadas

(por diámetro interior)

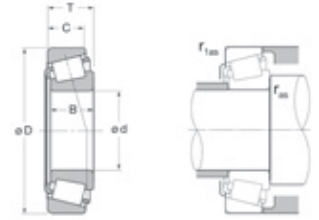

Diámetro interior (mm)	Glosario NTN	Diámetro exterior (D)	Ancho (mm)			Radio Máx (mm)		Peso (kg)	Capacidades (kN)	
			Anillo interior (B)	Anillo exterior (C)	Total (T)	Racores del árbol (r _{as} máx)	Racores del alojamiento (r _{ias} máx)		Carga dinámica (C)	Carga estática (C0)
26,988	4T-L44649/L44610	50,292	14,732	10,668	14,224	3,5	1,3	0,120	28,80	34,00
	4T-15580/15520	57,150	17,462	13,495	17,462	3,5	1,5	0,200	39,50	45,50
	4T-M84549/M84510	57,150	19,431	14,732	19,431	1,5	1,5	0,230	42,00	48,50
	4T-15106/15250	63,500	20,638	15,875	20,638	0,8	1,3	0,310	46,50	54,00
28,575	4T-15590/15520	57,150	17,462	13,495	17,462	3,5	1,5	0,196	39,50	45,50
	4T-1985/1922	57,150	19,355	15,875	19,845	0,8	1,5	0,230	40,50	44,50
	4T-1988/1922	57,150	19,355	15,875	19,845	3,5	1,5	0,220	40,50	44,50
	4T-15590/15523	60,325	17,462	15,875	19,842	3,5	1,5	0,250	39,50	45,50
	4T-15113/15245	62,000	20,638	14,288	19,050	0,8	1,3	0,280	46,50	54,00
	4T-15112/15250	63,500	20,638	15,875	20,638	3,5	1,3	0,300	46,50	54,00
	4T-M86647/M86610	64,292	21,433	16,670	21,433	1,5	1,5	0,348	51,50	64,50
	4T-2689/2631	66,421	25,433	19,050	23,812	1,3	1,3	0,416	64,50	72,50
	4T-02474/02420	68,262	22,225	17,462	22,225	0,8	1,5	0,409	57,00	67,00
	4T-M88040/M88010	68,262	22,225	17,462	22,225	2,3	1,5	0,410	57,50	73,50
	4T-41125/41286	72,626	24,257	17,462	24,608	4,8	1,5	0,477	58,00	55,50
	4T-02872/02820	73,025	22,225	17,462	22,225	0,8	3,3	0,480	56,50	68,00
4T-1985/1932	58,738	19,355	15,080	19,050	0,8	1,3	0,230	40,50	44,50	
29,000	4T-L45449/L45410	50,292	14,732	10,668	14,224	3,5	1,3	0,113	28,00	35,50
29,987	4T-17118/17244	62,000	16,566	14,288	16,002	1,5	1,5	0,228	39,00	42,00
	4T-15117/15245	62,000	20,638	14,288	19,050	1,3	1,3	0,269	46,50	54,00
	4T-15117/15244	62,000	20,638	15,875	20,638	1,3	1,3	0,270	46,50	54,00
30,000	4T-JHM88540/JHM88513PX1	72,000	27,783	23,020	29,370	1,3	3,3	0,618	72,00	97,00
	4T-14118/14283	72,085	19,202	18,415	22,385	0,8	2,3	0,440	48,50	58,00
30,162	4T-17119/17244	62,000	16,566	14,288	16,002	1,5	1,5	0,226	39,00	42,00
	4T-M86649/M86610	64,292	21,433	16,670	21,433	1,5	1,5	0,336	51,50	64,50
	4T-M88043/M88010	68,262	22,225	17,462	22,225	2,3	1,5	0,400	57,50	73,50
	4T-2558/2523S	69,850	25,357	19,050	23,812	2,3	1,3	0,468	69,00	81,50
30,213	4T-15118/15250X	63,500	20,638	15,875	20,638	3,5	1,5	0,298	46,50	54,00
30,226	4T-14116/14276	69,012	19,583	15,875	19,845	0,8	1,3	0,370	48,50	58,00
31,750	4T-08125/08231	58,738	15,080	10,716	14,683	1,0	1,0	0,170	28,20	32,50
	4T-LM67048/LM67010	59,131	16,764	11,811	15,875	1,8	1,3	0,180	34,50	41,00
	4T-LM67049A/LM67010	59,131	16,764	11,811	15,875	0,8	1,3	0,180	34,50	41,00
	4T-LM67048/LM67010	59,131	16,764	11,811	15,875	3,9	1,3	0,182	34,50	41,00
	4T-15123/15245	62,000	19,050	14,288	18,161	4,7	1,3	0,244	46,50	54,00
	4T-15125/15245	62,000	20,638	14,288	19,050	3,5	1,3	0,253	46,50	54,00
	4T-15123/15250X	63,500	19,050	15,875	20,638	1,3	1,5	0,260	46,50	54,00
	4T-2580/2520	66,421	25,357	20,638	25,400	0,8	3,3	0,409	69,00	81,50
	4T-M88046/M88010	68,262	22,225	17,462	22,225	1,5	1,5	0,390	57,50	73,50
	4T-14124/14276	69,012	19,583	15,875	19,845	0,8	1,3	0,359	48,50	58,00
	4T-14125A/14276	69,012	19,583	15,875	19,845	3,5	1,3	0,356	48,50	58,00
	4T-2580/2523	69,850	25,357	19,050	23,812	0,8	1,3	0,454	69,00	81,50
	4T-3188/3120	72,626	29,997	23,812	30,162	0,8	3,3	0,603	84,50	98,00
	4T-3188S/3120	72,626	29,997	23,812	30,162	1,5	3,3	0,603	84,50	98,00
	4T-HM88542/HM88510	73,025	27,783	23,020	29,370	1,3	3,3	0,622	72,00	97,00
	4T-43125/43312	79,375	24,074	17,462	25,400	1,5	1,5	0,580	65,50	67,00
	4T-14125A/14274	69,012	19,583	15,875	19,845	3,5	3,3	0,352	48,50	58,00
	4T-02475/02420	68,262	22,225	17,462	22,225	3,5	1,5	0,380	57,00	67,00
	4T-02476/02420	68,262	22,225	17,462	22,225	0,8	1,5	0,383	57,00	67,00
	4T-2580/2523S	69,850	25,357	19,050	23,812	0,8	1,3	0,455	69,00	81,50
33,338	4T-M88048/M88010	68,262	22,225	17,462	22,225	0,8	1,5	0,378	56,50	71,00
	4T-14130/14276	69,012	19,583	15,875	19,845	3,5	1,3	0,344	48,50	58,00
	4T-14131/14276	69,012	19,583	15,875	19,845	0,8	1,3	0,347	48,50	58,00
	4T-HM88547/HM88510	73,025	27,783	23,020	29,370	0,8	3,3	0,604	72,00	97,00
	4T-2790/2720	76,200	25,654	19,050	23,812	1,5	3,3	0,553	73,00	90,50
	4T-HM89443/HM89410	76,200	28,575	23,020	29,370	0,8	3,3	0,668	78,00	105,00
	4T-2585/2523	69,850	25,357	19,050	23,812	3,5	1,3	0,435	69,00	81,50

Gama dimensiones en pulgadas

(por diámetro interior)

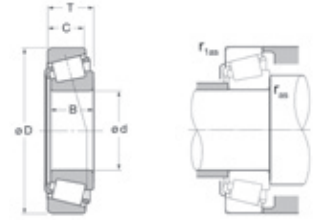

Diámetro interior (mm)	Glosario NTN	Diámetro exterior (D)	Ancho (mm)			Radio Máx (mm)		Peso (kg)	Capacidades (kN)	
			Anillo interior (B)	Anillo exterior (C)	Total (T)	Racores del árbol (r _{as} máx)	Racores del alojamiento (r _{1as} máx)		Carga dinámica (C)	Carga estática (C ₀)
34,925	4T-LM48548/LM48510	65,088	18,288	13,970	18,034	3,9	1,3	0,249	46,50	56,00
	4T-LM48548L/LM48510	65,088	18,288	13,970	18,034	3,5	1,3	0,255	46,50	56,00
	4T-14138A/14274	69,012	19,583	15,875	19,845	3,5	3,3	0,320	48,50	58,00
	4T-14137A/14276	69,012	19,583	15,875	19,845	1,5	1,3	0,333	48,50	58,00
	4T-14138A/14276	69,012	19,583	15,875	19,845	3,5	1,3	0,320	48,50	58,00
	4T-HM88649/HM88610	72,233	25,400	19,842	25,400	2,3	2,3	0,489	65,00	84,50
	4T-2878/2820	73,025	23,812	17,462	22,225	0,8	3,3	0,434	62,50	75,50
	4T-25877/25820	73,025	24,608	19,050	23,812	1,5	2,3	0,471	71,00	85,00
	4T-25877/25821	73,025	24,608	19,050	23,812	1,5	0,8	0,474	71,00	85,00
	4T-2793/2720	76,200	25,654	19,050	23,812	0,8	3,3	0,536	73,00	90,50
	4T-HM89446/HM89410	76,200	28,575	23,020	29,370	3,5	3,3	0,646	78,00	105,00
	4T-31593/31520	76,200	28,575	23,812	29,370	3,5	3,3	0,625	80,50	97,00
	4T-31594/31520	76,200	28,575	23,812	29,370	1,5	3,3	0,627	80,50	97,00
	4T-3478/3420	79,375	29,771	23,812	29,370	3,5	3,3	0,725	93,00	114,00
	4T-28137/28317	80,035	20,940	15,875	21,433	1,5	1,5	0,500	55,50	63,00
	4T-3379/3320	80,167	30,391	23,812	29,370	3,5	3,3	0,732	95,00	112,00
	4T-3872/3820	85,725	30,162	23,812	30,162	3,5	3,3	0,897	105,00	132,00
4T-02878/02820	73,025	22,225	17,462	22,225	0,8	3,3	0,425	56,50	68,00	
4T-25878/25820	73,025	24,608	19,050	23,812	3,5	2,3	0,468	71,00	85,00	
4T-2796/2729	76,200	25,654	19,050	23,812	3,5	0,8	0,536	73,00	90,50	
34,988	4T-L68149/L68110	59,131	16,764	11,938	15,875	3,5	1,3	0,170	35,50	47,50
	4T-L68149/L68111	59,974	16,764	11,938	15,875	3,9	1,3	0,179	35,50	47,50
35,000	4T-LM78349/LM78310APX2	62,000	17,000	13,600	16,700	2,5	1,5	0,206	33,00	29,20
	4T-JL68145/JL68111Z	60,000	18,410	11,938	15,875	2,0	1,3	0,180	35,50	47,50
35,717	4T-HM88648/HM88610PX1	72,233	25,400	19,842	25,400	3,5	2,3	0,477	65,00	84,50
36,487	4T-25880/25821	73,025	24,608	19,050	23,812	1,5	0,8	0,457	71,00	85,00
	4T-25880/25820	73,025	24,608	19,050	23,813	1,5	2,3	0,460	76,00	98,00
	4T-2780/2720	76,200	25,654	19,050	23,812	1,5	3,3	0,518	73,00	90,50
36,512	4T-HM89448/HM89410	76,200	28,575	23,020	29,370	0,8	3,3	0,629	78,00	105,00
	4T-HM89449/HM89410	76,200	28,575	23,020	29,370	3,5	3,3	0,626	78,00	105,00
	4T-HM89449/HM89411	76,200	28,575	23,020	29,370	3,5	0,8	0,631	78,00	105,00
	4T-31597/31520	76,200	28,575	23,812	29,370	3,5	3,3	0,605	80,50	97,00
	4T-HM89249/HM89210	79,375	28,829	22,664	29,370	3,5	3,3	0,686	86,50	104,00
38,000	4T-JL69349/JL69310	63,000	17,000	13,500	17,000	3,9	1,3	0,198	38,50	52,50
	4T-JL69345/JL69310	63,000	19,000	13,500	17,000	3,5	1,5	0,200	38,50	52,50
38,100	4T-13889/13830	63,500	11,908	9,525	12,700	1,5	0,8	0,147	25,90	33,50
	4T-LM29748/LM29710	65,088	18,288	13,970	18,034	3,9	1,3	0,233	43,50	57,00
	4T-LM29748L/LM29710	65,088	18,288	13,970	18,034	3,9	1,3	0,237	43,50	57,00
	4T-LM29749/LM29710	65,088	18,288	13,970	18,034	2,3	1,3	0,235	43,50	57,00
	4T-LM29749/LM29711	65,088	18,288	15,748	19,812	2,3	1,3	0,250	43,50	57,00
	4T-19150/19268	68,262	16,520	11,908	15,875	1,5	1,5	0,240	43,50	51,00
	4T-19150/19268X	68,275	16,520	16,032	20,000	1,5	1,5	0,280	43,50	51,00
	4T-13685/13621	69,012	19,050	15,083	19,050	3,5	2,3	0,293	47,50	59,50
	4T-13687/13621	69,012	19,050	15,083	19,050	2,0	2,3	0,296	47,50	59,50
	4T-19150/19283X	72,000	16,520	14,288	17,018	1,5	1,5	0,300	43,50	51,00
	4T-16150/16282	72,000	20,638	14,237	19,000	3,5	1,5	0,331	48,00	58,50
	4T-16150/16284	72,238	20,638	15,875	20,638	3,5	1,3	0,355	48,00	58,50
	4T-16150/16283	72,238	20,638	19,050	23,812	3,5	2,3	0,390	48,00	58,50
	4T-2788/2735X	73,025	25,654	19,050	23,775	3,5	0,8	0,440	73,00	90,50
	4T-28150/28300	76,200	20,940	15,507	20,638	1,5	1,3	0,405	55,50	63,00
	4T-2788/2729	76,200	25,654	19,050	23,775	3,5	0,8	0,500	73,00	90,50
	4T-2788/2720	76,200	25,654	19,050	23,812	3,5	3,3	0,497	73,00	90,50
	4T-26878/26822	79,375	25,400	19,050	23,812	0,8	0,8	0,574	76,50	97,50
	4T-3490/3420	79,375	29,771	23,812	29,370	3,5	3,3	0,683	93,00	114,00
	4T-HM801346/HM801310	82,550	28,575	23,020	29,370	0,8	3,3	0,767	87,00	117,00
	4T-HM801346X/HM801310	82,550	28,575	23,020	29,370	0,8	3,3	0,767	87,00	117,00
4T-3876/3820	85,725	30,162	23,812	30,162	3,5	3,3	0,854	105,00	132,00	
4T-44150/44348	88,500	23,698	17,462	25,400	2,3	1,5	0,711	70,50	78,00	
4T-418/414	88,500	29,083	22,225	26,988	3,5	1,5	0,840	95,50	107,00	

Gama dimensiones en pulgadas

(por diámetro interior)

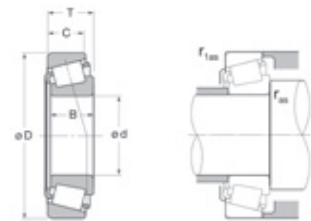

Diámetro interior (mm)	Glosario NTN	Diámetro exterior (D)	Ancho (mm)			Radio Máx (mm)		Peso (kg)	Capacidades (kN)	
			Anillo interior (B)	Anillo exterior (C)	Total (T)	Racores del árbol (r _{as} máx)	Racores del alojamiento (r _{1as} máx)		Carga dinámica (C)	Carga estática (C ₀)
39,688	4T-2789/2729	76,200	25,654	19,050	23,775	3,5	0,8	0,480	73,00	90,50
	4T-2789/2720	76,200	25,654	19,050	23,812	3,5	3,3	0,477	73,00	90,50
	4T-3386/3320	80,167	30,391	23,812	29,370	0,8	3,3	0,668	95,00	112,00
	4T-M201047/M201011	73,025	22,098	21,336	25,654	0,8	2,3	0,431	62,00	79,50
	4T-3386/3325	79,975	30,391	23,812	29,370	0,8	3,3	0,670	95,00	112,00
40,000	4T-344/332	80,000	22,403	17,826	21,000	3,5	1,3	0,479	68,00	75,00
	4T-28158/28300	76,200	20,940	15,507	20,638	1,5	1,3	0,386	55,50	63,00
	4T-344A/332	80,000	22,403	17,826	21,000	0,8	1,3	0,482	68,00	75,00
	4T-420/414	88,500	29,083	22,225	26,988	3,5	1,5	0,813	95,50	107,00
	4T-543/532X	107,950	36,957	28,575	36,512	3,5	3,3	1,770	141,00	177,00
40,483	4T-HM801349/HM801310	82,550	28,575	23,020	29,370	3,5	3,3	0,731	87,00	117,00
	4T-HM801349/HM801311	82,550	28,575	23,020	29,370	3,5	0,8	0,738	87,00	117,00
41,000	4T-LM300849/LM300811	67,975	18,000	13,500	17,500	3,9	1,5	0,239	46,00	62,50
41,275	4T-18590/18520	73,025	17,462	12,700	16,667	3,5	1,5	0,281	46,00	55,50
	4T-LM501349/LM501310	73,431	19,812	14,732	19,558	3,5	0,8	0,335	56,00	69,50
	4T-LM501349/LM501314	73,431	19,812	16,604	21,430	3,5	0,8	0,355	56,00	69,50
	4T-LM501349/LM501311	73,431	19,812	18,186	23,012	3,5	3,3	0,370	54,00	66,00
	4T-11162/11300	76,200	17,384	14,288	18,009	1,5	1,5	0,337	42,50	51,50
	4T-24780/24720	76,200	23,020	17,462	22,225	3,5	0,8	0,432	65,00	80,50
	4T-24780/24721	76,200	23,020	20,638	25,400	3,5	3,3	0,470	65,00	80,50
	4T-26882/26822	79,375	25,400	19,050	23,812	3,5	0,8	0,531	76,50	97,50
	4T-26882/26820	80,167	25,400	20,638	25,400	3,5	3,3	0,563	76,50	97,50
	4T-M802048/M802011	82,550	25,654	20,193	26,543	3,5	3,3	0,642	80,50	104,00
	4T-3877/3820	85,725	30,162	23,812	30,162	3,5	3,3	0,830	105,00	132,00
	4T-3585/3525	87,312	30,886	23,812	30,162	1,5	3,3	0,835	94,00	117,00
	4T-44162/44348	88,500	23,698	17,462	25,400	2,3	1,5	0,680	70,50	78,00
	4T-HM803145/HM803110	88,900	29,370	23,020	30,162	0,8	3,3	0,901	93,50	125,00
	4T-HM803146/HM803110	88,900	29,370	23,020	30,162	3,5	3,3	0,898	93,50	125,00
	4T-HM903245/HM903210	95,250	28,575	22,225	30,958	3,5	0,8	1,050	96,00	116,00
	4T-HM903245/HM903210PX1	95,250	28,575	22,225	30,958	3,5	0,8	1,048	96,00	116,00
	4T-HM804840/HM804810	95,250	29,370	23,020	30,162	3,5	3,3	1,080	109,00	147,00
	4T-526/522	101,600	36,068	26,988	34,925	3,5	3,3	1,420	135,00	165,00
	4T-3384/3320	80,167	30,391	23,812	29,370	0,8	3,3	0,649	95,00	112,00
	4T-M903345/M903310	92,075	23,812	16,670	26,195	3,5	1,5	0,758	72,50	81,50
42,862	4T-3579/3525	87,312	30,886	23,812	30,162	3,5	3,3	0,805	94,00	117,00
42,875	4T-25577/25520	82,931	25,400	19,050	23,812	3,5	0,8	0,581	76,00	98,00
	4T-25577/25523	82,931	25,400	22,225	26,988	3,5	3,3	0,610	76,00	98,00
	4T-25577/25521	83,058	25,400	19,050	23,812	3,5	3,3	0,560	76,00	98,00
	4T-25577/25522	83,058	25,400	19,114	23,876	3,5	2,0	0,583	76,00	98,00

Gama dimensiones en pulgadas

(por diámetro interior)

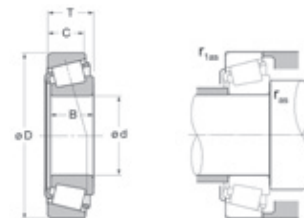

Diámetro interior (mm)	Glosario NTN	Diámetro exterior (D)	Ancho (mm)			Radio Máx (mm)		Peso (kg)	Capacidades (kN)	
			Anillo interior (B)	Anillo exterior (C)	Total (T)	Racores del árbol (r _{as} máx)	Racores del alojamiento (r _{1as} máx)		Carga dinámica (C)	Carga estática (C ₀)
44,450	4T-18685/18620	79,375	17,462	13,495	17,462	2,8	1,5	0,345	45,50	56,00
	4T-25580/25520	82,931	25,400	19,050	23,812	3,5	0,8	0,560	76,00	98,00
	4T-25581/25520	82,931	25,400	19,050	23,812	0,5	0,8	0,563	76,00	98,00
	4T-25580/25521	83,058	25,400	19,050	23,812	3,5	3,3	0,540	76,00	98,00
	4T-25580/25522	83,058	25,400	19,114	23,876	3,5	2,0	0,550	76,00	98,00
	4T-355X/354X	85,000	21,692	17,462	20,638	2,3	1,3	0,511	69,50	79,50
	4T-4370/4320	88,500	40,386	33,338	39,688	3,5	3,3	1,110	136,00	175,00
	4T-HM803149/HM803111	88,900	29,370	23,020	30,162	3,5	0,8	0,850	93,50	125,00
	4T-HM803149/HM803110	88,900	29,370	23,020	30,162	3,5	3,3	0,849	93,50	125,00
	4T-355X/352	90,119	21,692	21,808	23,000	3,5	2,3	0,670	69,50	79,50
	4T-HM803149/HM803112	92,075	29,370	23,020	30,162	3,5	3,3	0,920	93,50	125,00
	4T-3782/3720	93,264	30,302	23,812	30,162	3,5	3,3	0,961	102,00	134,00
	4T-53178/53375	95,250	28,300	20,638	30,958	2,0	0,8	0,927	82,50	92,00
	4T-33885/33822	95,250	28,575	22,225	27,783	0,8	0,8	0,970	107,00	139,00
	4T-HM903249/HM903210	95,250	28,575	22,225	30,958	3,5	0,8	1,000	96,00	116,00
	4T-HM804843/HM804810PX1	95,250	29,370	23,020	30,162	3,5	3,3	1,032	109,00	147,00
	4T-HM804842/HM804810	95,250	29,370	23,020	30,162	0,8	3,3	1,040	109,00	147,00
	4T-HM807040/HM807010	104,775	36,512	28,575	36,512	3,5	3,3	1,620	138,00	189,00
	4T-55175C/55437	111,125	26,909	20,638	30,162	3,5	3,3	1,450	104,00	136,00
	4T-55176/55437	111,125	26,909	20,638	30,162	0,8	3,3	1,090	104,00	136,00
	4T-535/532A	111,125	36,957	30,162	38,100	3,5	3,3	1,830	141,00	177,00
	4T-615/612	120,650	41,275	31,750	41,275	3,5	3,3	2,430	172,00	213,00
	4T-12175/12303	76,992	17,145	11,908	17,462	1,5	1,5	0,308	44,00	54,00
	4T-25580/25523	82,931	25,400	22,225	26,988	3,5	2,3	0,605	76,00	90,00
4T-3578/3525	87,312	30,886	23,812	30,162	3,5	3,3	0,779	94,00	117,00	
4T-53177/53375	95,250	28,300	20,638	30,958	3,5	0,8	0,925	82,50	92,00	
4T-438/432	95,250	29,900	22,225	27,783	3,5	2,3	0,953	108,00	129,00	
4T-527/522	101,600	36,068	26,988	34,925	3,5	3,3	1,370	135,00	165,00	
44,980	4T-25584/25521	82,830	25,400	19,050	23,810	1,5	3,3	0,560	76,00	98,00
44,983	4T-25584/25520	82,931	25,400	19,050	23,812	1,5	0,8	0,555	76,00	98,00
	4T-3776/3720	93,264	30,302	23,812	30,162	3,5	3,3	0,952	102,00	134,00
44,988	4T-HM905843/HM905810	104,986	31,750	23,368	32,512	2,5	2,5	1,380	113,00	151,00
45,000	4T-HM903248/HM903210	95,250	28,575	22,225	30,958	3,5	0,8	1,000	96,00	116,00
45,230	4T-17887/17831	79,985	20,638	15,080	19,842	2,0	1,3	0,400	59,50	75,50
45,237	4T-3586/3525	87,312	30,886	23,812	30,162	3,5	3,3	0,765	94,00	117,00
45,242	4T-LM102949/LM102910	73,431	19,812	15,748	19,558	3,5	0,8	0,307	54,00	76,00
	4T-LM603049/LM603011	77,788	19,842	15,080	19,842	3,5	0,8	0,372	57,50	73,50
	4T-LM603049/LM603012	77,788	19,842	16,667	21,430	3,5	0,8	0,391	57,50	73,50
	4T-LM603049/LM603014	79,974	19,842	15,080	19,842	3,5	0,8	0,405	57,50	73,50
45,618	4T-25590/25520	82,931	25,400	19,050	23,812	3,5	0,8	0,543	76,00	98,00
	4T-25590/25523	82,931	25,400	22,225	26,988	3,5	2,3	0,588	76,00	98,00
	4T-25590/25521	83,058	25,400	19,050	23,812	3,5	3,3	0,541	76,00	98,00
	4T-25590/25522	83,058	25,400	19,114	23,876	3,5	2,0	0,545	76,00	98,00
45,980	4T-HM204049/HM204010	90,975	32,000	26,500	32,000	3,5	3,5	0,920	117,00	147,00
45,987	4T-LM503349A/LM503310	74,976	18,000	14,000	18,000	3,5	1,5	0,290	51,00	71,00
	4T-LM503349/LM503310	74,976	18,000	14,000	18,000	3,9	1,5	0,296	51,00	71,00
46,038	4T-18690/18620	79,375	17,462	13,495	17,462	2,8	1,5	0,329	45,50	56,00
	4T-359S/354X	85,000	21,692	17,462	20,638	3,5	1,3	0,489	69,50	79,50
	4T-2984/2924	85,000	25,608	20,638	25,400	3,5	1,3	0,615	79,00	104,00
47,625	4T-369S/362A	88,900	22,225	16,513	20,638	2,3	1,3	0,561	76,50	90,50
	4T-M804049/M804010	88,900	25,400	19,050	25,400	3,5	3,3	0,657	82,00	101,00
	4T-3779/3720	93,264	30,302	23,812	30,162	3,5	3,3	0,904	102,00	134,00
	4T-HM804846/HM804810	95,250	29,370	23,020	30,162	3,5	3,3	0,978	109,00	147,00
	4T-386A/382A	96,838	21,946	15,875	21,000	0,8	0,8	0,720	78,00	96,50
	4T-528/522	101,600	36,068	26,988	34,925	3,5	3,3	1,300	135,00	165,00
	4T-55187C/55443	112,712	26,909	20,638	30,162	3,5	3,3	1,450	91,50	108,00
	4T-55187/55443	112,712	26,909	20,638	30,162	3,5	3,3	1,364	91,50	108,00
	4T-55187C/55437	111,125	26,909	20,638	30,162	3,5	3,3	1,400	104,00	136,00
4T-536/532X	107,950	36,957	28,575	36,512	3,5	3,3	1,617	141,00	177,00	

Gama dimensiones en pulgadas

(por diámetro interior)

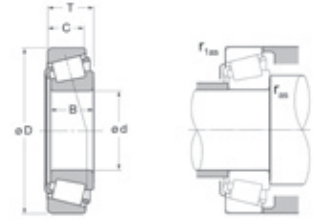

Diámetro interior (mm)	Glosario NTN	Diámetro exterior (D)	Ancho (mm)			Radio Máx (mm)		Peso (kg)	Capacidades (kN)	
			Anillo interior (B)	Anillo exterior (C)	Total (T)	Racores del árbol (r _{as} máx)	Racores del alojamiento (r _{1as} máx)		Carga dinámica (C)	Carga estática (C ₀)
48,412	4T-HM804848/HM804810	95,250	29,370	23,020	30,162	2,3	3,3	0,967	109,00	147,00
	4T-HM804849/HM804810	95,250	29,370	23,020	30,162	3,5	3,3	0,964	109,00	147,00
49,212	4T-5395/5335	103,188	44,475	36,512	43,658	3,5	3,3	1,750	174,00	232,00
	4T-HM807044/HM807010	104,775	36,512	28,575	36,512	3,5	3,3	1,520	138,00	189,00
	4T-65390/65320	114,300	44,450	34,925	44,450	3,5	3,3	2,230	186,00	225,00
50,000	4T-JLM104948/JLM104910	82,000	21,500	17,000	21,500	3,0	0,5	0,420	69,50	94,00
	4T-JLM704649/JLM704610PK	84,000	22,000	17,500	22,000	3,5	1,5	0,466	69,50	94,50
	4T-365/362	88,900	22,225	16,513	20,638	2,0	1,3	0,530	76,50	90,50
	4T-JM205149/JM205110	90,000	28,000	23,000	28,000	3,0	2,5	0,752	106,00	141,00
	4T-JM205149/JM205110PK	90,000	28,000	23,000	28,000	3,0	2,5	0,750	106,00	141,00
	4T-JHM807045/JHM807012	105,000	36,000	29,000	37,000	3,0	2,5	1,520	138,00	189,00
4T-365/362A	88,900	22,225	16,513	20,638	2,0	1,3	0,530	76,50	90,50	
50,800	4T-LM104949/LM104911	82,550	22,225	16,510	21,590	3,5	1,3	0,419	69,50	94,00
	4T-LM104949/LM104912	82,931	22,225	16,510	21,590	3,5	1,3	0,425	69,50	94,00
	4T-18790/18720	85,000	17,462	13,495	17,462	3,5	1,5	0,374	49,50	65,00
	4T-368A/362A	88,900	22,225	16,513	20,638	3,5	1,3	0,516	76,50	90,50
	4T-28580/28521	92,075	25,400	19,845	24,608	3,5	0,8	0,703	83,50	116,00
	4T-3780/3720	93,264	30,302	23,812	30,162	3,5	3,3	0,848	102,00	134,00
	4T-33889/33822	95,250	28,575	22,225	28,575	3,5	0,8	0,879	107,00	139,00
	4T-529/522	101,600	36,068	26,988	34,925	0,8	3,3	1,240	135,00	165,00
	4T-529X/522	101,600	36,068	26,988	34,925	3,5	3,3	1,230	135,00	165,00
	4T-45284/45220	104,775	30,958	23,812	30,162	6,4	3,3	1,220	130,00	169,00
	4T-45285/45220	104,775	30,958	23,812	30,162	2,3	3,3	1,230	130,00	169,00
	4T-HM807046/HM807010	104,775	36,512	28,575	36,512	3,5	3,3	1,490	138,00	189,00
	4T-4580/4535	104,775	40,157	33,338	39,687	3,5	3,3	1,620	151,00	212,00
	4T-537/532X	107,950	36,957	28,575	36,512	3,5	3,3	1,550	141,00	177,00
	4T-55200C/55437	111,125	26,909	20,638	30,162	3,5	3,3	1,360	91,50	108,00
	4T-HM907643/HM907614	111,125	28,575	20,638	30,162	3,5	3,3	1,360	104,00	136,00
	4T-66200/66462	117,475	31,750	23,812	33,338	3,5	3,3	1,670	130,00	153,00
	4T-72200C/72487	123,825	32,791	25,400	36,512	3,5	3,3	2,100	154,00	188,00
	4T-65200/65500	127,000	44,450	34,925	44,450	3,5	3,3	2,880	203,00	263,00
	4T-368/362	88,900	22,225	16,513	20,638	1,5	1,3	0,519	76,50	90,50
4T-368A/362	90,000	22,225	15,875	20,000	3,5	2,0	0,525	76,50	90,50	
4T-49585/49520	101,600	31,750	25,400	31,750	3,5	3,3	1,130	110,00	136,00	
4T-59200/59412	104,775	36,512	28,575	36,512	3,5	3,3	1,440	143,00	178,00	
4T-537/532A	111,125	36,957	30,162	38,100	3,5	3,3	1,718	141,00	177,00	
52,388	4T-28584/28521	92,075	25,400	19,845	24,608	3,5	0,8	0,677	83,50	116,00
	4T-33891/33821	95,250	28,575	22,225	27,783	3,5	2,3	0,847	107,00	139,00
	4T-3767/3720	93,264	30,302	23,812	30,162	2,3	3,3	0,819	102,00	134,00
53,975	4T-LM806649/LM806610	88,900	19,050	13,492	19,050	2,3	2,0	0,437	61,00	82,50
	4T-33895/33822	95,250	28,575	22,225	27,783	1,5	0,8	0,824	107,00	139,00
	4T-HM807049/HM807010	104,775	36,512	28,575	36,512	3,5	3,3	1,410	138,00	189,00
	4T-539/532X	107,950	36,957	28,575	36,512	3,5	3,3	1,470	141,00	177,00
	4T-66584/66520	122,238	31,750	23,812	33,338	3,5	3,3	1,790	134,00	163,00
	4T-72212C/72487	123,825	32,791	25,400	36,512	3,5	3,3	2,030	154,00	188,00
	4T-65212/65500	127,000	44,450	34,925	44,450	3,5	3,3	2,790	203,00	263,00
	4T-6280/6220	127,000	52,388	41,275	50,800	3,5	3,3	3,250	250,00	320,00
	4T-78214/78551	140,030	33,236	23,520	36,512	0,8	2,3	2,770	171,00	212,00
	4T-78214C/78551	140,030	33,236	23,520	36,512	0,8	2,3	2,770	171,00	212,00
	4T-33895/33821	95,250	28,575	22,225	27,783	1,5	2,3	0,821	107,00	139,00
	4T-45287/45220	104,775	30,958	23,812	30,162	0,8	3,3	1,170	130,00	169,00
4T-78215C/78551	140,030	33,236	23,520	36,512	3,5	2,3	2,760	171,00	212,00	
54,488	4T-HM807048/HM807010	104,775	36,512	28,575	36,512	3,5	3,3	1,400	138,00	189,00
55,000	4T-JLM506849/JLM506810	90,000	23,000	18,500	23,000	1,5	0,5	0,558	77,50	109,00
	4T-JM207049/JM207010	95,000	29,000	23,500	29,000	1,5	2,5	0,820	107,00	144,00
	4T-JH307749/JH307710	110,000	39,000	32,000	39,000	3,0	2,5	1,710	173,00	219,00
55,562	4T-28680/28622	97,630	24,608	19,446	24,608	3,5	0,8	0,774	88,50	128,00
	4T-HM813840/HM813810	127,000	36,512	26,988	36,512	3,5	3,3	2,340	163,00	228,00
	4T-72218C/72487	123,825	32,791	25,400	36,512	3,5	3,3	1,990	154,00	188,00

Gama dimensiones en pulgadas

(por diámetro interior)

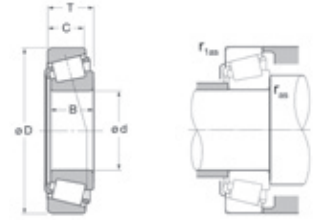

Diámetro interior (mm)	Glosario NTN	Diámetro exterior (D)	Ancho (mm)			Radio Máx (mm)		Peso (kg)	Capacidades (kN)	
			Anillo interior (B)	Anillo exterior (C)	Total (T)	Racores del árbol (r _{as} máx)	Racores del alojamiento (r _{1as} máx)		Carga dinámica (C)	Carga estática (C ₀)
57,150	4T-387/382	98,425	21,946	17,600	21,000	2,3	0,8	0,629	79,30	98,40
	4T-387/382A	96,838	21,946	15,875	21,000	2,3	0,8	0,583	78,00	96,50
	4T-387A/382A	96,838	21,946	15,875	21,000	3,5	0,8	0,581	78,00	96,50
	4T-28682/28622	97,630	24,608	19,446	24,608	3,5	0,8	0,747	88,50	128,00
	4T-387A/382	98,425	21,946	17,826	21,000	3,5	0,8	0,628	78,00	96,50
	4T-387A/383A	100,000	21,946	17,826	21,000	3,5	2,0	0,660	78,00	96,50
	4T-462/453X	104,775	29,317	24,605	30,162	2,3	3,3	1,060	115,00	148,00
	4T-462A/453X	104,775	29,317	24,605	30,162	2,3	3,3	1,060	115,00	148,00
	4T-469/453X	104,775	29,317	24,605	30,162	3,5	3,3	1,060	115,00	148,00
	4T-45289/45220	104,775	30,958	23,812	30,162	0,8	3,3	1,100	130,00	169,00
	4T-45291/45220	104,775	30,958	23,812	30,162	6,4	3,3	1,090	130,00	169,00
	4T-390/394A	110,000	21,996	18,824	22,000	2,3	1,3	0,954	89,50	120,00
	4T-39580/39520	112,712	30,162	23,812	30,162	3,5	3,3	1,410	138,00	195,00
	4T-39581/39520	112,712	30,162	23,812	30,162	8,0	3,3	1,400	138,00	195,00
	4T-66225/66462	117,475	31,750	23,812	33,338	3,5	3,3	1,540	130,00	153,00
	4T-623/612	120,650	41,275	31,750	41,275	3,5	3,3	2,120	172,00	213,00
	4T-78225/78551	140,030	33,236	23,520	36,512	3,5	2,3	2,690	171,00	212,00
4T-387AS/382A	96,838	21,946	15,875	21,000	5,0	0,8	0,576	78,00	96,50	
4T-387A/382S	96,838	21,946	20,274	25,400	3,5	2,3	0,650	78,00	96,50	
4T-555S/552A	123,825	36,678	30,162	38,100	3,5	3,3	2,180	158,00	216,00	
57,531	4T-388A/382	98,425	21,946	17,826	21,000	3,5	0,8	0,621	78,00	96,50
59,987	4T-H913840/H913810	146,050	39,688	25,400	41,275	3,5	3,3	3,220	199,00	234,00
60,000	4T-JLM508748/JLM508710	95,000	24,000	19,000	24,000	5,0	2,5	0,606	83,00	122,00
60,325	4T-28985/28921	100,000	25,400	19,845	25,400	3,5	3,3	0,772	90,50	134,00
	4T-28985/28920	101,600	25,400	19,845	25,400	3,5	3,3	0,811	90,50	134,00
	4T-3980/3920	112,712	30,048	23,812	30,162	3,5	3,3	1,330	119,00	174,00
	4T-65237/65500	127,000	44,450	34,925	44,450	3,5	3,3	2,650	203,00	263,00
	4T-HM911245/HM911210	130,175	33,338	23,812	36,512	5,0	3,3	2,120	156,00	186,00
	4T-78238/78537	136,525	33,236	23,520	36,512	5,0	3,3	2,330	171,00	212,00
4T-5583/5535	122,238	43,764	36,512	43,658	3,5	3,3	2,440	194,00	283,00	
61,912	4T-H715334/H715311	136,525	46,038	36,512	46,038	3,5	3,3	3,470	224,00	355,00
	4T-H913842/H913810	146,050	39,688	25,400	41,275	3,5	3,3	3,170	199,00	234,00
62,738	4T-28995/28921	100,000	25,400	19,845	25,400	3,5	3,3	0,700	90,50	134,00
63,500	4T-L610549/L610510	94,458	19,050	15,083	19,050	1,5	1,5	0,449	60,50	103,00
	4T-39250/39412	104,775	22,000	15,875	21,433	2,0	2,0	0,680	83,50	108,00
	4T-29585/29520	107,950	25,400	19,050	25,400	3,5	3,3	0,924	91,50	140,00
	4T-29586/29520	107,950	25,400	19,050	25,400	1,5	3,3	0,929	91,50	140,00
	4T-390A/394A	110,000	21,996	18,824	22,000	1,5	1,3	0,851	89,50	120,00
	4T-395/394A	110,000	21,996	18,824	22,000	3,5	1,3	0,847	89,50	120,00
	4T-29585/29521	110,000	25,400	19,050	25,400	3,5	1,3	0,982	91,50	140,00
	4T-3982/3920	112,712	30,048	23,812	30,162	3,5	3,3	1,260	119,00	174,00
	4T-39585/39520	112,712	30,162	23,812	30,162	3,5	3,3	1,270	138,00	195,00
	4T-HM212047/HM212011	122,238	38,354	29,718	38,100	7,0	3,3	1,940	187,00	244,00
	4T-5584/5535	122,238	43,764	36,512	43,658	3,5	3,3	2,340	194,00	283,00
	4T-559/552A	123,825	36,678	30,162	38,100	3,5	3,3	2,010	158,00	216,00
	4T-639/632	136,525	41,275	31,750	41,275	3,5	3,3	2,850	194,00	262,00
	4T-78250/78551	140,030	33,236	23,520	36,512	2,3	2,3	2,540	171,00	212,00
	4T-29586/29522	107,950	25,400	19,050	25,400	1,5	0,8	0,935	91,50	140,00
4T-HM212047/HM212010	122,238	38,354	29,718	38,100	7,0	1,5	1,948	187,00	244,00	
4T-565/563	127,000	36,170	28,575	36,512	3,5	3,3	2,110	163,00	229,00	
65,000	4T-JLM710949/JLM710910	105,000	23,000	18,500	24,000	3,0	1,0	0,742	85,00	117,00
	4T-JM511946/JM511910	110,000	28,000	22,500	28,000	3,0	2,5	1,080	119,00	174,00
	4T-JH211749/JH211710PK	210,000	38,500	32,000	39,000	3,0	2,5	1,860	185,00	248,00
65,088	4T-6379/6320	135,755	56,007	44,450	53,975	3,5	3,3	3,710	278,00	380,00
65,987	4T-H212749/H212710	123,975	41,500	34,000	41,500	7,0	3,5	2,130	205,00	277,00

Gama dimensiones en pulgadas

(por diámetro interior)

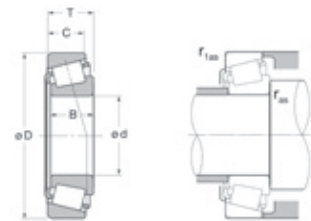

Diámetro interior (mm)	Glosario NTN	Diámetro exterior (D)	Ancho (mm)			Radio Máx (mm)		Peso (kg)	Capacidades (kN)	
			Anillo interior (B)	Anillo exterior (C)	Total (T)	Racores del árbol (ras máx)	Racores del alojamiento (r1as máx)		Carga dinámica (C)	Carga estática (C0)
66,675	4T-29590/29520	107,950	25,400	19,050	25,400	3,5	3,3	0,860	91,50	140,00
	4T-29590/29522	107,950	25,400	19,050	25,400	3,5	0,8	0,800	91,50	140,00
	4T-395A/394A	110,000	21,996	18,824	22,000	0,8	1,3	0,796	89,50	120,00
	4T-395S/394A	110,000	21,996	18,824	22,000	3,5	1,3	0,791	89,50	120,00
	4T-395A/394	110,000	21,996	22,000	22,000	0,8	0,8	0,830	89,50	120,00
	4T-29590/29521	110,000	25,400	19,050	25,400	3,5	1,3	0,910	91,50	140,00
	4T-3984/3920	112,712	30,048	23,812	30,162	3,5	3,3	1,180	119,00	174,00
	4T-3994/3920	112,712	30,048	23,812	30,162	5,5	3,3	1,180	119,00	174,00
	4T-39590/39520	112,712	30,162	23,812	30,162	3,5	3,3	1,190	138,00	195,00
	4T-HM212049/HM212010	122,238	38,354	29,718	38,100	3,5	1,5	1,860	187,00	244,00
	4T-HM212049/HM212011	122,238	38,354	29,718	38,100	3,5	3,3	1,850	187,00	244,00
	4T-6386/6320	135,755	56,007	44,450	53,975	4,3	3,3	3,640	278,00	380,00
	4T-641/632	136,525	41,275	31,750	41,275	3,5	3,3	2,740	194,00	262,00
	4T-H414242/H414210	136,525	41,275	31,750	41,275	3,5	3,3	2,750	226,00	293,00
	4T-H715341A/H715311	136,525	46,038	36,512	46,038	7,0	3,3	3,280	224,00	355,00
	4T-33262/33462	117,475	30,162	23,812	30,162	3,5	3,3	1,358	117,00	175,00
4T-560/552A	123,825	36,678	30,162	38,100	3,5	3,3	1,920	158,00	216,00	
4T-HM813844/HM813810	127,000	36,512	26,988	36,512	3,5	3,3	2,030	163,00	228,00	
68,262	4T-399A/394A	110,000	21,996	18,824	22,000	2,3	1,3	0,764	89,50	120,00
	4T-399AS/394A	110,000	21,996	18,824	22,000	5,0	1,3	0,756	89,50	120,00
	4T-H414245/H414210	136,525	41,275	31,750	41,275	3,5	3,3	2,700	226,00	293,00
	4T-H715343/H715311	136,525	46,038	36,512	46,038	3,5	3,3	3,240	224,00	355,00
	4T-9278/9220	161,925	46,038	31,750	49,212	3,5	3,3	4,640	255,00	300,00
	4T-9185/9121	152,400	46,038	31,750	47,625	3,5	3,3	3,788	244,00	277,00
69,850	4T-L713049/L713010	101,600	19,050	15,083	19,050	1,5	1,5	0,510	60,50	106,00
	4T-29675/29620	112,712	25,400	19,050	25,400	1,5	3,3	0,949	95,50	151,00
	4T-33275/33462	117,475	30,162	23,812	30,162	3,5	3,3	1,280	117,00	175,00
	4T-482/472	120,000	29,007	24,237	29,794	3,5	2,0	1,330	128,00	177,00
	4T-47487/47420	120,000	32,545	26,195	32,545	3,5	3,3	1,470	147,00	214,00
	4T-643/632	136,525	41,275	31,750	41,275	3,5	3,3	2,630	194,00	262,00
	4T-H913849/H913810	146,050	39,688	25,400	41,275	3,5	3,3	2,850	199,00	234,00
	4T-655/653	146,050	41,275	31,750	41,275	3,5	3,3	3,280	206,00	295,00
	4T-745A/742	150,089	46,672	36,512	44,450	3,5	3,3	3,920	261,00	360,00
	4T-835/832	168,275	56,363	41,275	53,975	3,5	3,3	6,130	340,00	460,00
4T-482/472X	123,825	29,007	24,605	30,162	3,5	3,3	1,480	128,00	111,00	
4T-566/563	127,000	36,170	28,575	36,512	3,5	3,3	1,920	163,00	229,00	
69,988	4T-H715347/H715311	136,525	46,038	36,512	46,038	3,5	3,3	3,170	224,00	355,00
70,000	4T-JLM813049/JLM813010PK	110,000	25,000	20,500	26,000	1,0	2,5	0,889	97,00	150,00
	4T-JM612949/JM612910PK	115,000	29,000	23,000	29,000	3,0	2,5	1,130	124,00	171,00
	4T-484/472	120,000	29,007	24,237	29,794	2,0	2,0	1,330	128,00	177,00
71,438	4T-33281/33462	117,475	30,162	23,812	30,162	3,5	3,3	1,240	117,00	175,00
	4T-33281/33472	120,000	30,162	23,444	29,794	3,5	0,8	1,300	117,00	175,00
	4T-47490/47420	120,000	32,545	26,195	32,545	3,5	3,3	1,420	147,00	214,00
	4T-567A/563	127,000	36,170	28,575	36,512	3,5	3,3	1,870	163,00	229,00
	4T-HM813849/HM813810	127,000	36,512	26,988	36,512	3,5	3,3	1,870	163,00	228,00
	4T-645/632	136,525	41,275	31,750	41,275	6,4	3,3	2,530	194,00	262,00
	4T-H414249/H414210	136,525	41,275	31,750	41,275	3,5	3,3	2,580	226,00	293,00
	4T-H715345/H715311	136,525	46,038	36,512	46,038	3,5	3,3	3,110	224,00	355,00
4T-H715345/H715310	139,700	46,038	36,512	46,038	3,5	3,3	3,302	224,00	355,00	
73,025	4T-29685/29620	112,712	25,400	19,050	25,400	3,5	3,3	0,873	95,50	151,00
	4T-33287/33462	117,475	30,162	23,812	30,162	3,5	3,3	1,190	117,00	175,00
	4T-6460/6420	149,225	54,229	44,450	53,975	3,5	3,3	4,420	287,00	410,00
73,817	4T-29688/29620	112,712	25,400	19,050	25,400	1,5	3,3	0,860	95,50	151,00
	4T-568/563	127,000	36,170	28,575	36,512	0,8	3,3	1,800	163,00	229,00
75,000	4T-JLM714149/JLM714110PK	115,000	25,000	19,000	25,000	3,0	2,5	0,875	94,50	143,00
	4T-JM714249/JM714210PK	120,000	29,500	25,000	31,000	3,0	2,5	1,300	131,00	197,00
	4T-JH415647/JH415610PK	140,000	51,000	42,000	51,000	3,0	2,5	3,810	287,00	410,00
	4T-JH415647/JH415610	145,000	51,000	42,000	51,000	3,0	2,5	3,810	287,00	410,00
75,987	4T-HM215249/HM215210	131,976	39,000	32,000	39,000	7,0	3,5	2,110	197,00	281,00

Gama dimensiones en pulgadas

(por diámetro interior)

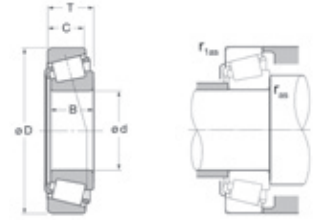

Diámetro interior (mm)	Glosario NTN	Diámetro exterior (D)	Ancho (mm)			Radio Máx (mm)		Peso (kg)	Capacidades (kN)	
			Anillo interior (B)	Anillo exterior (C)	Total (T)	Racores del árbol (r_{as} máx)	Racores del alojamiento (r_{1as} máx)		Carga dinámica (C)	Carga estática (C0)
76,200	4T-L814749/L814710	109,538	19,050	15,083	19,050	1,5	1,5	0,579	63,00	115,00
	4T-34300/34478	121,442	23,012	17,462	24,608	2,0	2,0	0,982	91,00	127,00
	4T-34301/34478	121,442	23,012	17,462	24,608	3,5	2,0	0,977	91,00	127,00
	4T-42687/42620	127,000	31,000	22,225	30,162	3,5	3,3	1,460	135,00	194,00
	4T-47679/47620	133,350	33,338	26,195	33,338	3,5	3,3	1,930	153,00	235,00
	4T-575/572	139,992	36,098	28,575	36,512	3,5	3,3	2,430	178,00	265,00
	4T-575/572X	139,992	36,098	28,575	36,512	3,5	3,3	2,430	178,00	265,00
	4T-HM515745/HM515716	142,138	46,100	33,338	44,450	3,5	3,3	2,860	200,00	278,00
	4T-748S/742	150,089	46,672	36,512	44,450	3,5	3,3	3,660	261,00	360,00
	4T-9285/9220ST	161,925	46,038	31,750	49,212	3,5	3,3	4,310	255,00	300,00
4T-9378/9321	171,450	50,800	31,750	49,212	3,5	3,3	5,350	265,00	325,00	
4T-H917840/H917810	180,975	53,183	35,720	53,975	3,5	3,3	6,570	325,00	415,00	
4T-495A/493	136,525	29,769	22,225	30,162	3,5	3,3	1,830	129,00	189,00	
77,788	4T-LM814849/LM814810	117,475	25,400	19,050	25,400	3,5	3,3	0,932	99,50	162,00
	4T-34306/34478	121,442	23,012	17,462	24,608	3,5	2,0	0,943	91,00	127,00
	4T-34306/34500	127,000	23,012	19,842	26,988	3,5	3,3	1,130	91,00	127,00
	4T-42690/42620	127,000	31,000	22,225	30,162	3,5	3,3	1,410	135,00	194,00
	4T-H715348/H715311	136,525	46,038	36,512	46,038	3,5	3,3	2,840	224,00	355,00
79,974	4T-HM218238/HM218210	146,975	40,000	32,500	40,000	7,0	3,5	2,990	277,00	340,00
80,000	4T-JM515649/JM515610PK	130,000	34,000	28,500	35,000	3,0	2,5	1,710	166,00	249,00
80,962	4T-581/572	139,992	36,098	28,575	36,512	3,5	3,3	2,260	178,00	265,00
	4T-47681/47620	133,350	33,338	26,195	33,338	3,5	3,3	1,780	153,00	235,00
82,550	4T-L116149/L116110PX2	115,888	21,433	16,670	20,638	1,5	1,5	0,650	78,00	133,00
	4T-27687/27620	125,412	25,400	19,845	25,400	3,5	1,5	1,070	102,00	163,00
	4T-495/492A	133,350	29,769	22,225	30,162	3,5	3,3	1,490	129,00	189,00
	4T-47686/47620	133,350	33,338	26,195	33,338	3,5	3,3	1,720	153,00	235,00
	4T-580/572	139,992	36,098	28,575	36,512	3,5	3,3	2,200	178,00	265,00
	4T-663/653	146,050	41,275	31,750	41,275	3,5	3,3	2,780	206,00	295,00
	4T-749A/742	150,089	46,672	36,512	44,450	3,5	3,3	3,370	261,00	360,00
	4T-842/832	168,275	56,363	41,275	53,975	3,5	3,3	5,460	340,00	460,00
	4T-495/493	136,525	29,769	22,225	30,162	3,5	3,3	1,640	129,00	189,00
	4T-47687/47620	133,350	33,338	26,195	33,338	6,8	3,3	1,710	153,00	235,00
4T-580/572X	139,992	36,098	28,575	36,512	3,5	3,3	2,200	178,00	265,00	
4T-6559/6535	161,925	55,100	42,862	53,975	3,5	3,3	5,099	310,00	460,00	
83,345	4T-27690/27620	125,412	25,400	19,845	25,400	3,5	1,5	1,050	102,00	163,00
84,976	4T-27695/27620	125,412	25,400	19,845	25,400	5,0	1,5	0,810	102,00	163,00
85,000	4T-JM716649/JM716610	130,000	29,000	24,000	30,000	3,0	2,5	1,390	135,00	214,00
	4T-JM716648/JM716610PK	130,000	29,000	24,000	30,000	6,0	2,5	1,320	135,00	214,00
85,026	4T-749/742	150,089	46,672	36,512	44,450	3,5	3,3	3,250	261,00	360,00
85,725	4T-497/492A	133,350	29,769	22,225	30,162	3,5	3,3	1,430	129,00	189,00
	4T-497/493	136,525	29,769	22,225	30,162	3,5	3,3	1,550	129,00	189,00
	4T-665/653	146,050	41,275	31,750	41,275	3,5	3,3	2,650	206,00	295,00
	4T-HM617049/HM617010	142,138	42,862	34,133	42,862	4,8	3,3	2,690	216,00	350,00
88,900	4T-L217849/L217810	123,825	20,638	16,670	20,638	1,5	1,5	0,737	80,00	141,00
	4T-42350/42584	148,430	28,971	21,433	28,575	3,0	3,0	1,960	138,00	215,00
	4T-HM518445/HM518410	152,400	39,688	30,162	39,688	6,4	3,3	2,810	252,00	365,00
	4T-759/752	161,925	48,260	38,100	47,625	3,5	3,3	4,090	270,00	385,00
	4T-6580/6535	161,925	55,100	42,862	53,975	3,5	3,3	4,730	310,00	460,00
	4T-850/832	168,275	56,363	41,275	53,975	3,5	3,3	5,080	340,00	460,00
4T-98350/98788	200,000	49,212	34,925	52,761	3,5	3,3	7,550	345,00	470,00	
4T-HH221434/HH221410	190,500	57,531	46,038	57,150	8,0	3,3	7,940	445,00	610,00	
89,974	4T-HM218248/HM218210	146,975	40,000	32,500	40,000	7,0	3,5	2,550	227,00	340,00
90,000	4T-JM718149/JM718110PK	140,000	34,000	27,000	35,000	3,0	2,5	2,140	189,00	279,00
	4T-JHM318448/JHM318410	155,000	44,000	35,500	44,000	3,0	2,5	3,320	270,00	385,00
	4T-6581X/6525X	160,000	55,100	44,450	53,975	3,0	3,0	4,470	310,00	460,00
	4T-J90354/J90748	190,000	46,038	31,750	50,800	3,5	3,3	6,320	281,00	365,00
92,075	4T-47890/47820	146,050	34,925	26,195	33,338	3,5	3,3	2,080	163,00	266,00
	4T-598A/592A	152,400	36,322	30,162	39,688	6,4	3,3	2,630	180,00	279,00
95,000	4T-JL819349/JL819310	135,000	20,000	14,000	20,000	5,0	2,5	0,840	76,50	129,00
	4T-JM719149/JM719113	150,000	34,000	27,000	35,000	3,0	2,5	2,190	180,00	279,00

Gama dimensiones en pulgadas

(por diámetro interior)

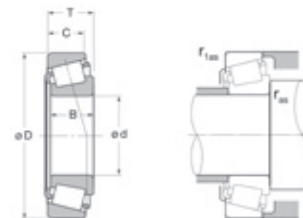

Diámetro interior (mm)	Glosario NTN	Diámetro exterior (D)	Ancho (mm)			Radio Máx (mm)		Peso (kg)	Capacidades (kN)	
			Anillo interior (B)	Anillo exterior (C)	Total (T)	Racores del árbol (r_{as} máx)	Racores del alojamiento (r_{1as} máx)		Carga dinámica (C)	Carga estática (C0)
95,250	4T-LL319349/LL319310	128,587	15,083	11,908	15,875	1,5	1,5	0,530	61,00	99,00
	4T-L319249/L319210	130,175	21,433	16,670	20,638	1,5	1,5	0,789	81,00	147,00
	4T-47896/47820	146,050	34,925	26,195	33,338	3,5	3,3	1,950	163,00	266,00
	4T-42375/42584	148,430	28,971	21,433	28,575	3,0	3,0	1,750	138,00	215,00
	4T-594/593X	150,000	36,322	27,000	35,992	3,5	3,0	2,200	174,00	267,00
	4T-594/592A	152,400	36,322	30,162	39,688	3,5	3,3	2,510	180,00	279,00
	4T-594A/592A	152,400	36,322	30,162	39,688	5,0	3,3	2,510	180,00	279,00
	4T-683/672	168,275	41,275	30,162	41,275	3,5	3,3	3,720	222,00	340,00
4T-594/592	147,638	36,322	26,192	35,717	5,0	3,3	2,090	180,00	279,00	
96,838	4T-42381/42584	148,430	28,971	21,433	28,575	3,5	3,0	1,690	138,00	215,00
96,838	4T-90381/90744	188,912	46,038	31,750	50,800	3,5	3,3	5,670	281,00	365,00
98,425	4T-52387/52618	157,162	36,116	26,195	36,512	3,5	3,3	2,620	188,00	305,00
	4T-HH421246/HH421210	184,150	63,500	52,388	63,500	6,4	3,3	7,530	435,00	675,00
99,974	4T-HM220149/HM220110	156,975	42,000	34,000	42,000	8,0	3,5	2,820	248,00	380,00
100,000	4T-JM720249/JM720210	155,000	35,000	28,000	36,000	3,0	2,5	2,400	192,00	310,00
	4T-JHM720249/JHM720210	160,000	40,000	32,000	41,000	3,0	2,5	3,040	235,00	370,00
100,012	4T-52393/52618	157,162	36,116	26,195	36,512	3,5	3,3	2,550	188,00	305,00
101,600	4T-L420449/L420410	136,525	21,433	16,670	21,433	1,5	1,5	0,850	85,00	159,00
	4T-52401/52618	157,162	36,116	26,195	36,512	8,0	3,3	2,410	188,00	300,00
	4T-52400/52618	157,162	36,116	26,195	36,512	3,5	3,3	2,480	188,00	305,00
	4T-687/672	168,275	41,275	30,162	41,275	3,5	3,3	3,400	222,00	340,00
	4T-780/772	180,975	48,006	38,100	47,625	3,5	3,3	5,110	285,00	430,00
	4T-HH221449/HH221410	190,500	57,531	46,038	57,150	8,0	3,3	7,060	445,00	610,00
	4T-98400/98788	200,000	49,212	34,925	52,761	3,5	3,3	6,820	345,00	470,00
	4T-HH224335/HH224310	212,725	66,675	53,975	66,675	7,0	3,3	11,300	575,00	810,00
4T-HH923649/HH923610	250,825	73,025	50,800	76,200	6,4	6,4	17,480	590,00	750,00	
4T-861/854	190,500	57,531	44,450	57,150	8,0	3,3	7,000	380,00	555,00	
104,775	4T-782/772	180,975	48,006	38,100	47,625	3,5	3,3	4,920	285,00	430,00
106,362	4T-56418/56650	165,100	36,512	26,988	36,512	3,5	3,3	2,700	191,00	315,00
107,950	4T-37425/37625	158,750	21,438	15,875	23,020	3,5	3,3	1,370	102,00	166,00
	4T-48190/48120	161,925	34,925	26,988	34,925	3,5	3,3	2,340	159,00	266,00
	4T-56426/56650	165,100	36,512	26,988	36,512	8,0	3,3	2,550	191,00	315,00
	4T-56425/56650	165,100	36,512	26,988	36,512	3,5	3,3	2,690	191,00	315,00
	4T-936/932	212,725	66,675	53,975	66,675	8,0	3,3	10,700	475,00	695,00
109,538	4T-37431/37625	158,750	21,438	15,875	23,020	3,5	3,3	1,330	102,00	166,00
	4T-37431A/37625	158,750	21,438	15,875	23,020	3,5	3,3	1,330	102,00	166,00
109,975	4T-64432/64708	179,975	41,275	30,162	41,275	3,5	3,3	3,850	232,00	375,00
109,987	4T-LM522548/LM522510	159,987	34,925	26,988	34,925	8,0	3,3	2,240	167,00	320,00
	4T-LM522549/LM522510	159,987	34,925	26,988	34,925	3,5	3,3	2,270	167,00	320,00
110,000	4T-JM822049/JM822010	165,000	35,000	26,500	35,000	3,0	2,5	2,520	191,00	315,00
	4T-JHM522649/JHM522610	180,000	46,000	38,000	47,000	3,0	2,5	4,610	305,00	480,00
111,125	4T-H924045/H924010	214,312	52,388	39,688	55,562	3,5	3,3	8,180	405,00	560,00
114,975	4T-HH224349/HH224310V2	212,725	66,675	53,975	66,675	7,0	3,3	10,370	575,00	810,00
117,475	4T-68462/68712	180,975	31,750	25,400	34,925	3,5	3,3	2,780	169,00	245,00
120,650	4T-L624549/L624510	160,338	21,433	16,670	21,433	1,5	1,5	1,160	92,50	188,00
	4T-HH228340/HH228310	254,000	82,550	61,912	77,788	9,7	6,4	18,800	740,00	1070,00
	4T-HH228340/HH228310V3	254,000	82,550	61,912	77,788	9,7	6,4	19,420	740,00	1070,00
	4T-HH228340/HH228318V4	259,974	82,550	61,912	77,788	9,7	6,4	19,420	740,00	1070,00
123,825	4T-48286/48220	182,562	38,100	33,338	39,688	3,5	3,3	3,520	224,00	435,00
125,298	4T-HM926745/HM926710	228,600	49,428	38,100	53,975	3,5	3,3	8,870	430,00	620,00
127,000	4T-LL225749/LL225710	165,895	17,462	13,495	18,257	1,5	1,5	0,920	81,50	144,00
	4T-L225849/L225810	169,862	26,195	20,638	25,400	1,5	1,5	1,610	123,00	246,00
	4T-48290/48220	182,562	38,100	33,338	39,688	3,5	3,3	3,330	224,00	435,00
	4T-67388/67322	196,850	46,038	38,100	46,038	3,5	3,3	5,100	310,00	550,00
	4T-95500/95925	234,950	63,500	49,212	63,500	6,4	3,3	12,000	525,00	825,00
	4T-HH228349/HH228310	254,000	82,550	61,912	77,788	9,7	6,4	19,500	740,00	1070,00
133,350	4T-L327249/L327210	177,008	26,195	20,638	25,400	1,5	1,5	1,700	126,00	259,00
	4T-48385/48320	190,500	39,688	33,338	39,688	3,5	3,3	3,640	236,00	475,00
	4T-67390/67322	196,850	46,038	38,100	46,038	3,5	3,3	4,630	310,00	550,00
	4T-95525/95925	234,950	63,500	49,212	63,500	9,7	3,3	11,300	525,00	825,00

Gama dimensiones en pulgadas

(por diámetro interior)

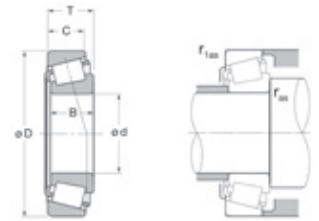

Diámetro interior (mm)	Glosario NTN	Diámetro exterior (D)	Ancho (mm)			Radio Máx (mm)		Peso (kg)	Capacidades (kN)	
			Anillo interior (B)	Anillo exterior (C)	Total (T)	Racores del árbol (r _{as} máx)	Racores del alojamiento (r _{1as} máx)		Carga dinámica (C)	Carga estática (C ₀)
136,525	4T-48393/48320	190,500	39,688	33,338	39,688	3,5	3,3	3,430	236,00	475,00
139,700	4T-898/892	228,600	57,150	44,450	57,150	3,5	3,3	8,760	445,00	735,00
142,875	4T-48685/48620	200,025	39,688	34,130	41,275	3,5	3,3	3,890	239,00	490,00
146,050	4T-36690/36620	193,675	28,575	23,020	28,575	1,5	1,5	2,270	165,00	340,00
152,400	4T-M231649/M231610	222,250	46,830	34,925	46,830	3,5	1,5	5,770	315,00	585,00
	4T-99600/99100	254,000	66,675	47,625	66,675	7,0	3,3	12,470	550,00	910,00
158,750	4T-L433749/L433710	205,580	23,810	18,260	23,810	1,5	1,5	1,890	126,00	247,00
	4T-L432349/L432310	205,583	23,812	18,258	23,812	1,5	1,5	1,890	126,00	247,00
170,000	4T-JHM534149/JHM534110PK	230,000	38,000	31,000	39,000	3,0	2,5	4,320	282,00	520,00
	4T-JM734449/JM734410	240,000	44,500	37,000	46,000	3,0	2,5	6,280	325,00	590,00
174,625	4T-67787/67720	247,650	47,625	38,100	47,625	3,5	3,3	6,960	340,00	690,00
177,800	4T-36990/36920	227,012	30,162	23,020	30,162	1,5	1,5	2,920	181,00	415,00
	4T-67790/67720	247,650	47,625	38,100	47,625	3,5	3,3	6,570	340,00	690,00
	4T-M236849/M236810	260,350	53,975	41,275	53,975	3,5	3,3	9,050	445,00	825,00
180,000	4T-JM736149/JM736110	250,000	45,000	37,000	47,000	3,0	2,5	6,760	370,00	710,00
187,325	4T-M238849/M238810	269,875	55,562	42,862	55,563	3,5	3,3	9,880	460,00	875,00
190,000	4T-JM738249/JM738210	260,000	44,000	36,500	46,000	3,0	2,5	6,850	365,00	720,00
196,850	4T-LL639249/LL639210	241,300	23,017	17,462	23,812	1,5	1,5	2,070	160,00	330,00

Gama dimensiones métricas

(por diámetro interior)

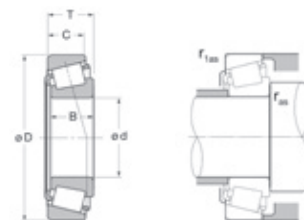

Diámetro interior (mm)	Glosario simplificado	Glosario NTN	Diámetro exterior (D)	Ancho (mm)			Radio máx (mm)		Peso (kg)	Capacidades (kN)	
				Anillo interior (B)	Anillo exterior (C)	Total (T)	Racores del árbol (r_{as} máx)	Racores del alojamiento (r_{1as} máx)		Carga dinámica (C)	Carga estática (C0)
15	30202	30202	35	11	10,0	11,75	0,6	0,6	0,052	13,4	12,3
	30302	4T-30302	42	13	11,0	14,25	1,0	1,0	0,098	23,2	20,8
17	30203	4T-30203	40	12	11,0	13,25	1,0	1,0	0,080	20,5	20,3
	30303	4T-30303	47	14	12,0	15,25	1,0	1,0	0,134	28,9	26,3
20	32004	4T-32004X	42	15	12,0	15,00	0,6	0,6	0,097	24,9	27,9
	30204	4T-30204	47	14	12,0	15,25	1,0	1,0	0,127	28,2	28,7
	32204	4T-32204	47	18	15,0	19,25	1,0	1,0	0,160	36,5	39,5
	30304	4T-30304	52	15	13,0	16,25	1,5	1,5	0,169	35,5	34,0
32304	4T-32304	52	21	18,0	22,25	1,5	1,5	0,245	46,5	48,5	
22	320/22	4T-320/22X	44	15	11,5	15,00	0,6	0,6	0,106	27,0	31,5
25	32005	4T-32005X	47	15	11,5	15,00	0,6	0,6	0,114	27,8	33,5
	33005	4T-33005	47	17	14,0	17,00	0,6	0,6	0,130	32,5	40,5
	32005	4T-32005	52	15	13,0	16,25	1,0	1,0	0,154	31,5	34,0
	32205	4T-32205	52	18	16,0	19,25	1,0	1,0	0,181	38,0	43,0
	33205	4T-33205	52	22	18,0	22,00	1,0	1,0	0,217	47,5	57,5
	31305	4T-30305D	62	17	13,0	18,25	1,5	1,5	0,284	40,5	43,5
	30305	4T-30305	62	17	15,0	18,25	1,5	1,5	0,272	48,5	47,5
32305	4T-32305	62	24	20,0	25,25	1,5	1,5	0,381	61,5	64,5	
28	320/28	4T-320/28X	52	16	12,0	16,00	1,0	1,0	0,146	33,0	40,5
	302/28	4T-302/28	58	16	14,0	17,25	1,0	1,0	0,203	42,0	44,5
30	32006	4T-32006X	55	17	13,0	17,00	1,0	1,0	0,166	37,5	46,0
	33006	4T-33006	55	20	16,0	20,00	1,0	1,0	0,201	42,5	54,0
	30206	4T-30206	62	16	14,0	17,25	1,0	1,0	0,241	43,5	48,0
	32206	4T-32206	62	20	17,0	21,25	1,0	1,0	0,301	54,5	64,0
	33206	4T-33206	62	25	19,5	25,00	1,0	1,0	0,344	65,0	77,0
	31306	4T-30306D	72	19	14,0	20,75	1,5	1,5	0,398	48,5	51,5
	30306	4T-30306	72	19	16,0	20,75	1,5	1,5	0,408	60,0	61,0
32306	4T-32306	72	27	23,0	28,75	1,5	1,5	0,583	81,0	90,0	
32	320/32	4T-320/32X	58	17	13,0	17,00	1,0	1,0	0,181	37,0	46,5
	302/32	302/32	65	17	15,0	18,25	1,0	1,0	0,260	41,5	44,0
35	32007	4T-32007X	62	18	14,0	18,00	1,0	1,0	0,224	41,5	52,5
	30207	4T-30207	72	17	15,0	18,25	1,5	1,5	0,344	55,5	61,5
	32207	4T-32207	72	23	19,0	24,25	1,5	1,5	0,457	72,5	87,0
	33207	4T-33207	72	28	22,0	28,00	1,5	1,5	0,531	87,5	109,0
	31307	4T-30307D	80	21	15,0	22,75	2,0	1,5	0,530	63,5	70,0
	30307	4T-30307	80	21	18,0	22,75	2,0	1,5	0,540	75,0	77,0
	32307	4T-32307	80	31	25,0	32,75	2,0	1,5	0,787	101,0	115,0
40	32008	4T-32008X	68	19	14,5	19,00	1,0	1,0	0,273	50,0	65,5
	33008	4T-33008	68	22	18,0	22,00	1,0	1,0	0,312	59,5	82,5
	30208	4T-30208	80	18	16,0	19,75	1,5	1,5	0,435	61,0	67,0
	32208	4T-32208	80	23	19,0	24,75	1,5	1,5	0,558	79,5	93,5
	33208	4T-33208	80	32	25,0	32,00	1,5	1,5	0,728	103,0	132,0
	31308	4T-30308D	90	23	17,0	25,25	2,0	1,5	0,738	77,0	85,5
	30308	4T-30308	90	23	20,0	25,25	2,0	1,5	0,769	91,5	102,0
32308	4T-32308	90	33	27,0	35,25	2,0	1,5	1,080	122,0	150,0	
45	32009	4T-32009X	75	20	15,5	20,00	1,0	1,0	0,346	57,5	76,5
	33109	4T-33109	80	26	20,5	26,00	1,5	1,5	0,542	84,5	115,0
	30209	4T-30209	85	19	16,0	20,75	1,5	1,5	0,495	67,5	78,5
	32209	4T-32209	85	23	19,0	24,75	1,5	1,5	0,607	82,0	100,0
	33209	4T-33209	85	32	25,0	32,00	1,5	1,5	0,783	107,0	141,0
	31309	4T-30309D	100	25	18,0	27,25	2,0	1,5	0,958	96,0	109,0
	30309	4T-30309	100	25	22,0	27,25	2,0	1,5	1,010	111,0	126,0
	32309	32309U	100	36	30,0	38,25	2,0	1,5	1,460	154,0	191,0

Gama dimensiones métricas

(por diámetro interior)

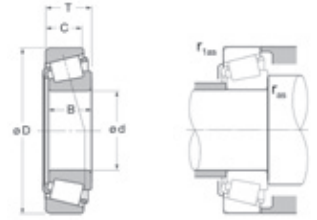

Diámetro interior (mm)	Glosario simplificado	Glosario NTN	Diámetro exterior (D)	Ancho (mm)			Radio máx (mm)		Peso (kg)	Capacidades (kN)	
				Anillo interior (B)	Anillo exterior (C)	Total (T)	Racores del árbol (r _{as} máx)	Racores del alojamiento (r _{1as} máx)		Carga dinámica (C)	Carga estática (C ₀)
50	32910	32910	72	14	12,0	15,00	0,6	0,6	0,191	35,5	57,0
	32010	4T-32010X	80	20	15,5	20,00	1,0	1,0	0,366	62,5	88,0
	33010	4T-33010	80	24	19,0	24,00	1,0	1,0	0,433	69,5	103,0
	33110	4T-33110	85	26	20,0	26,00	1,5	1,5	0,580	86,5	121,0
	30210	4T-30210	90	20	17,0	21,75	1,5	1,5	0,563	77,0	93,0
	32210	4T-32210	90	23	19,0	24,75	1,5	1,5	0,648	87,5	109,0
	33210	4T-33210	90	32	24,5	32,00	1,5	1,5	0,852	115,0	158,0
	31310	4T-30310D	110	27	19,0	29,25	2,0	2,0	1,250	113,0	130,0
	30310	4T-30310	110	27	23,0	29,25	2,0	2,0	1,310	133,0	152,0
	32310	32310U	110	40	33,0	42,25	2,0	2,0	1,920	184,0	232,0
55	32911	32911XU	80	17	14,0	17,00	1,0	1,0	0,274	44,5	73,5
	32011	4T-32011X	90	23	17,5	23,00	1,5	1,5	0,563	80,5	118,0
	33011	4T-33011	90	27	21,0	27,00	1,5	1,5	0,643	91,5	138,0
	33111	4T-33111	95	30	23,0	30,00	1,5	1,5	0,846	111,0	155,0
	30211	4T-30211	100	21	18,0	22,75	2,0	1,5	0,740	93,0	111,0
	32211	4T-32211	100	25	21,0	26,75	2,0	1,5	0,876	108,0	134,0
	33211	4T-33211	100	35	27,0	35,00	2,0	1,5	1,150	138,0	188,0
	31311	4T-30311D	120	29	21,0	31,50	2,0	2,0	1,590	132,0	154,0
	30311	4T-30311	120	29	25,0	31,50	2,0	2,0	1,660	155,0	179,0
32311	32311U	120	43	35,0	45,50	2,0	2,0	2,440	215,0	275,0	
60	32912	32912XA	85	17	14,0	17,00	1,0	1,0	0,296	51,0	83,0
	32012	32012XU	95	23	17,5	23,00	1,5	1,5	0,576	82,0	123,0
	33012	4T-33012	95	27	21,0	27,00	1,5	1,5	0,684	93,5	145,0
	33112	33112U	100	30	23,0	30,00	1,5	1,5	0,912	113,0	164,0
	30212	4T-30212	110	22	19,0	23,75	2,0	1,5	0,949	105,0	125,0
	32212	32212U	110	28	24,0	29,75	2,0	1,5	1,180	130,0	164,0
	33212	33212U	110	38	29,0	38,00	2,0	1,5	1,550	161,0	223,0
	31312	4T-30312D	130	31	22,0	33,50	2,5	2,0	1,970	150,0	176,0
	30312	30312U	130	31	26,0	33,50	2,5	2,0	2,060	180,0	210,0
	32312	32312U	130	46	37,0	48,50	2,5	2,0	3,020	244,0	315,0
65	32913	32913XU	90	17	14,0	17,00	1,0	1,0	0,315	48,5	85,0
	32013	32013XU	100	23	17,5	23,00	1,5	1,5	0,630	83,0	128,0
	33013	4T-33013	100	27	21,0	27,00	1,5	1,5	0,732	97,5	156,0
	33113	4T-33113	110	34	26,5	34,00	1,5	1,5	1,280	144,0	211,0
	30213	4T-30213	120	23	20,0	24,75	2,0	1,5	1,180	123,0	148,0
	32213	32213U	120	31	27,0	32,75	2,0	1,5	1,580	159,0	206,0
	33213	33213U	120	41	32,0	41,00	2,0	1,5	1,980	195,0	265,0
	31313	4T-30313D	140	33	23,0	36,00	2,5	2,0	2,420	173,0	204,0
	30313	30313U	140	33	28,0	36,00	2,5	2,0	2,550	203,0	238,0
	32313	32313U	140	48	39,0	51,00	2,5	2,0	3,660	273,0	350,0
70	32914	32914XU	100	20	16,0	20,00	1,0	1,0	0,487	68,5	110,0
	32014	32014XU	110	25	19,0	25,00	1,5	1,5	0,848	105,0	160,0
	33014	33014U	110	31	25,5	31,00	1,5	1,5	1,070	127,0	204,0
	33114	33114U	120	37	29,0	37,00	2,0	1,5	1,660	171,0	251,0
	30214	30214U	125	24	21,0	26,25	2,0	1,5	1,260	131,0	162,0
	32214	32214U	125	31	27,0	33,25	2,0	1,5	1,680	166,0	220,0
	33214	33214U	125	41	32,0	41,00	2,0	1,5	2,100	201,0	282,0
	31314	4T-30314D	150	35	25,0	38,00	2,5	2,0	2,920	193,0	229,0
	30314	30314U	150	35	30,0	38,00	2,5	2,0	3,060	230,0	272,0
	32314	32314U	150	51	42,0	54,00	2,5	2,0	4,460	310,0	405,0
75	32915	32915XU	105	20	16,0	20,00	1,0	1,0	0,511	69,5	114,0
	32015	32015XU	115	25	19,0	25,00	1,5	1,5	0,909	106,0	167,0
	33015	33015U	115	31	25,5	31,00	1,5	1,5	1,110	111,0	186,0
	33115	4T-33115	125	37	29,0	37,00	2,0	1,5	1,740	170,0	252,0
	30215	4T-30215	130	25	22,0	27,25	2,0	1,5	1,410	139,0	175,0
	32215	32215U	130	31	27,0	33,25	2,0	1,5	1,740	168,0	224,0
	33215	33215U	130	41	31,0	41,00	2,0	1,5	2,200	208,0	298,0
	31315	30315DU	160	37	26,0	40,00	2,5	2,0	3,470	215,0	256,0
	30315	30315U	160	37	31,0	40,00	2,5	2,0	3,570	255,0	305,0
	32315	32315U	160	55	45,0	58,00	2,5	2,0	5,350	355,0	470,0

Gama dimensiones métricas

(por diámetro interior)

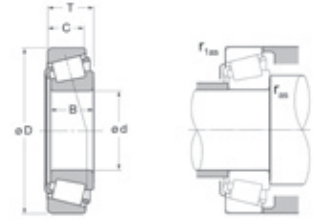

Diámetro interior (mm)	Glosario simplificado	Glosario NTN	Diámetro exterior	Ancho (mm)			Radio máx (mm)		Peso (kg)	Capacidades (kN)	
				Anillo interior	Anillo exterior	Total	Racores del árbol (r _{as} máx)	Racores del alojamiento (r _{1as} máx)		Carga dinámica (C)	Carga estática (C ₀)
(d)			(D)	(B)	(C)	(T)				(C)	(C ₀)
80	32916	32916XU	110	20	16,0	20,00	1,0	1,0	0,540	72,0	121,0
	32016	32016XU	125	29	22,0	29,00	1,5	1,5	1,280	139,0	216,0
	33016	33016U	125	36	29,5	36,00	1,5	1,5	1,600	173,0	284,0
	33116	33116U	130	37	29,0	37,00	2,0	1,5	1,870	179,0	276,0
	30216	30216U	140	26	22,0	28,25	2,0	2,0	1,720	160,0	200,0
	32216	32216U	140	33	28,0	35,25	2,0	2,0	2,180	199,0	265,0
	33216	33216U	140	46	35,0	46,00	2,0	2,0	2,920	250,0	365,0
	31316	30316DU	170	39	27,0	42,50	2,5	2,0	4,110	236,0	283,0
	30316	30316U	170	39	33,0	42,50	2,5	2,0	4,410	291,0	350,0
	32316	32316U	170	58	48,0	61,50	2,5	2,0	6,410	395,0	525,0
85	32917	32917XU	120	23	18,0	23,00	1,5	1,5	0,773	94,0	157,0
	32017	32017XU	130	29	22,0	29,00	1,5	1,5	1,350	142,0	224,0
	33017	33017U	130	36	29,5	36,00	1,5	1,5	1,700	176,0	296,0
	33117	33117U	140	41	32,0	41,00	2,0	2,0	2,440	211,0	330,0
	30217	30217U	150	28	24,0	30,50	2,0	2,0	2,140	183,0	232,0
	32217	32217U	150	36	30,0	38,50	2,0	2,0	2,750	224,0	300,0
	33217	33217U	150	49	37,0	49,00	2,0	2,0	3,580	284,0	420,0
	31317	30317DU	180	41	28,0	44,50	3,0	2,5	4,850	247,0	293,0
	30317	30317U	180	41	34,0	44,50	3,0	2,5	5,200	305,0	365,0
32317	32317U	180	60	49,0	63,50	3,0	2,5	7,150	405,0	525,0	
90	32918	32918XU	125	23	18,0	23,00	1,5	1,5	0,817	97,5	168,0
	32018	32018XU	140	32	24,0	32,00	2,0	1,5	1,790	168,0	270,0
	33018	33018U	140	39	32,5	39,00	2,0	1,5	2,180	215,0	360,0
	33118	33118U	150	45	35,0	35,00	2,0	2,0	3,110	253,0	400,0
	30218	30218U	160	30	26,0	32,50	2,0	2,0	2,660	208,0	267,0
	32218	32218U	160	40	34,0	42,50	2,0	2,0	3,490	262,0	360,0
	33218	33218U	160	55	42,0	55,00	2,0	2,0	4,620	325,0	490,0
	31318	30318DU	190	43	30,0	46,50	3,0	2,5	5,660	270,0	320,0
	30318	30318U	190	43	36,0	46,50	3,0	2,5	6,030	335,0	405,0
	32318	32318U	190	64	53,0	67,50	3,0	2,5	8,570	450,0	595,0
95	32919	32919XU	130	23	18,0	23,00	1,5	1,5	0,851	101,0	178,0
	32019	32019XU	145	32	24,0	32,00	2,0	1,5	1,830	171,0	280,0
	33019	4T-33019	145	39	32,5	39,00	2,0	1,5	2,270	219,0	375,0
	30219	30219U	170	32	27,0	34,50	2,5	2,0	3,070	226,0	290,0
	32219	32219U	170	43	37,0	45,50	2,5	2,0	4,300	299,0	415,0
	31319	30319DU	200	45	32,0	49,50	3,0	2,5	6,470	296,0	355,0
	30319	30319U	200	45	38,0	49,50	3,0	2,5	6,980	365,0	445,0
	32319	32319U	200	67	55,0	71,50	3,0	2,5	10,100	505,0	670,0
	100	32920	32920XU	140	25	20,0	25,00	1,5	1,5	1,140	121,0
32020		32020XU	150	32	24,0	32,00	2,0	1,5	1,910	170,0	281,0
33020		33020U	150	39	32,5	39,00	2,0	1,5	2,370	224,0	390,0
30220		30220U	180	34	29,0	37,00	2,5	2,0	3,780	258,0	335,0
32220		32220U	180	46	39,0	49,00	2,5	2,0	5,120	330,0	465,0
33220		33220U	180	63	48,0	63,00	2,5	2,0	6,760	415,0	650,0
30320		30320U	215	47	39,0	51,50	3,0	2,5	8,560	410,0	500,0
31320		31320XU	215	51	35,0	56,50	3,0	2,5	8,670	355,0	435,0
32320	32320U	215	73	60,0	77,50	3,0	2,5	12,700	570,0	770,0	
105	32921	32921XA	145	25	20,0	25,00	1,5	1,5	1,200	126,0	219,0
	32021	32021XU	160	35	26,0	35,00	2,0	2,0	2,420	201,0	335,0
	33021	33021U	160	43	34,0	43,00	2,0	2,0	3,000	245,0	420,0
	30221	30221U	190	36	30,0	39,00	2,5	2,0	4,390	287,0	380,0
	32221	32221U	190	50	43,0	53,00	2,5	2,0	6,250	380,0	540,0
	30321	30321U	225	49	41,0	53,50	3,0	2,5	9,790	435,0	530,0
	32321	32321U	225	77	63,0	81,50	3,0	2,5	14,500	610,0	825,0

Gama dimensiones métricas

(por diámetro interior)

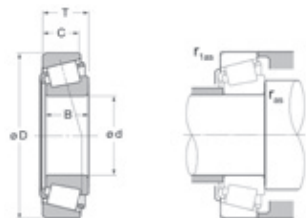

Diámetro interior (mm) (d)	Glosario simplificado	Glosario NTN	Diámetro exterior (D)	Ancho (mm)			Radio máx (mm)		Peso (kg)	Capacidades (kN)	
				Anillo interior (B)	Anillo exterior (C)	Total (T)	Racores del árbol (r _{as} máx)	Racores del alojamiento (r _{1as} máx)		Carga dinámica (C)	Carga estática (C ₀)
110	32922	32922XA	150	25	20,0	25,00	1,5	1,5	1,230	127,0	226,0
	32022	32022XU	170	38	29,0	38,00	2,0	2,0	3,070	236,0	390,0
	33022	33022U	170	47	37,0	47,00	2,0	2,0	3,800	288,0	500,0
	33122	33122UE1	180	56	43,0	56,00	2,0	2,0	5,520	360,0	610,0
	30222	30222U	200	38	32,0	41,00	2,5	2,0	5,180	325,0	435,0
	32222	32222U	200	53	46,0	56,00	2,5	2,0	7,430	420,0	605,0
	30322	30322U	240	50	42,0	54,50	3,0	2,5	11,400	480,0	590,0
32322	32322U	240	80	65,0	84,50	3,0	2,5	18,000	705,0	970,0	
120	32924	32924	165	27	23,0	29,00	1,5	1,5	1,650	118,0	205,0
	32024	32024XU	180	38	29,0	38,00	2,0	2,0	3,250	245,0	420,0
	33024	33024U	180	48	38,0	48,00	2,0	2,0	4,140	293,0	520,0
	30224	30224U	215	40	34,0	43,50	2,5	2,0	6,230	345,0	470,0
	32224	32224U	215	58	50,0	61,50	2,5	2,0	9,080	460,0	680,0
	30324	30324U	260	55	46,0	59,50	3,0	2,5	14,200	560,0	695,0
	32324	32324U	260	86	69,0	90,50	3,0	2,5	22,400	815,0	1130,0
130	32926	32926	180	30	26,0	32,00	2,0	2,0	2,220	142,0	252,0
	32026	32026XU	200	45	34,0	45,00	2,0	2,0	4,960	320,0	545,0
	30226	30226U	230	40	34,0	43,75	3,0	2,5	7,250	375,0	505,0
	32226	32226U	230	64	54,0	67,75	3,0	2,5	11,200	530,0	815,0
	30326	30326U	280	58	49,0	63,75	4,0	3,0	17,400	650,0	830,0
140	32928	32928XU	190	32	25,0	32,00	2,0	1,5	2,510	200,0	375,0
	32028	32028XU	210	45	34,0	45,00	2,0	2,0	5,280	330,0	580,0
	33028	33028U	210	56	44,0	56,00	2,0	2,0	6,590	390,0	715,0
	30228	30228U	250	42	36,0	45,75	3,0	2,5	9,260	420,0	570,0
	32228	32228U	250	68	58,0	71,75	3,0	2,5	14,100	610,0	920,0
	30328	30328U	300	62	53,0	67,75	4,0	3,0	21,200	735,0	950,0
150	32930	32930XU	210	38	30,0	38,00	2,0	2,0	3,920	268,0	490,0
	32030	32030XU	225	48	36,0	48,00	2,5	2,0	6,370	370,0	655,0
	33030	4T-33030	225	59	46,0	59,00	2,5	2,0	8,070	460,0	860,0
	30230	30230U	270	45	38,0	49,00	3,0	2,5	11,200	450,0	605,0
	32230	32230U	270	73	60,0	77,00	3,0	2,5	18,200	700,0	1070,0
160	32932	32932XU	220	38	30,0	38,00	2,0	2,0	4,150	276,0	520,0
	32032	32032XU	240	51	38,0	51,00	2,5	2,0	7,800	435,0	790,0
	30232	30232U	290	48	40,0	52,00	3,0	2,5	12,900	525,0	720,0
	32232	4T-32232	290	80	67,0	84,00	3,0	2,5	23,500	890,0	1420,0
170	32934	32934XU	230	38	30,0	38,00	2,0	2,0	4,400	286,0	560,0
	32034	32034XU	260	57	43,0	57,00	2,5	2,0	10,500	500,0	895,0
	30234	30234U	310	52	43,0	57,00	4,0	3,0	17,000	610,0	845,0
	32234	32234UUTG	310	86	71,0	91,00	4,0	3,0	28,700	1000,0	1600,0
180	32936	32936XU	250	45	34,0	45,00	2,0	2,0	6,540	350,0	700,0
	30236	30236U	320	52	43,0	57,00	4,0	3,0	17,700	630,0	890,0
	32236	32236UUTG	320	86	71,0	91,00	4,0	3,0	30,700	1030,0	1690,0
190	32938	32938XU	260	45	34,0	45,00	2,0	2,0	6,770	355,0	710,0
	32038	32038XUE1	290	64	48,0	64,00	2,5	2,0	15,100	655,0	1210,0
	30238	30238U	340	55	46,0	60,00	4,0	3,0	20,800	715,0	1000,0
	32238	32238U	340	92	75,0	97,00	4,0	3,0	36,100	1150,0	1850,0
200	32940	32940XUE1	280	51	39,0	51,00	2,5	2,0	8,880	485,0	895,0
	32040	32040XUE1	310	70	53,0	70,00	2,5	2,0	19,300	800,0	1470,0
220	32044	4T-32044X	340	76	57,0	76,00	3,0	2,5	25,000	920,0	1690,0
240	32048	4T-32048X	360	76	57,0	76,00	3,0	2,5	26,800	930,0	1760,0
260	32052	32052XU	400	87	65,0	87,00	4,0	3,0	39,400	1200,0	2270,0
360	32972	32972XUE1	480	76	57,0	76,00	3,0	2,5	36,600	1050,0	2330,0





RODAMIENTOS DE RODILLOS CÓNICOS

Este documento es de la exclusiva propiedad de NTN-SNR ROULEMENTS. Cualquier reproducción total o parcial del mismo sin el previo consentimiento de NTN-SNR ROULEMENTS está estrictamente prohibida, pudiéndose iniciar acciones legales contra cualquier persona que incumpla los términos de este párrafo.

NTN-SNR ROULEMENTS no podrá ser considerado responsable de ningún error u omisión que pudiera haberse producido en este documento a pesar del cuidado puesto al redactarlo. Debido a nuestra política de investigación y desarrollo continuos, nos reservamos el derecho a introducir cambios sin previo aviso en todos o en parte de los productos y especificaciones mencionados en este documento.

© NTN-SNR ROULEMENTS, international copyright 2019.

NTN-SNR ROULEMENTS - 1 rue des Usines - 74000 Annecy
RCS ANNECY B 325 821 072 - Code APE 2815Z - Code NACE 28.15
www.ntn-snr.com

NTN **SNR**



With You



DOC1_TFB_DISTIB_CAT2_Ea - SAP 000000 - Document non contractuel - NTN-SNR copyright international - 11/19 - Photos: NTN-SNR - PedroStudioPhoto - Shutterstock.